



AV. FORTUNATO ERNESTO VETORASSO, Nº4569
BAIRRO: AEROPORTO
CEP: 15.135-194
EMAIL: assistencia@rvmoveis.com.br
FONE: (17) 3243-7010

MANUAL DE MONTAGEM

CAMARIM



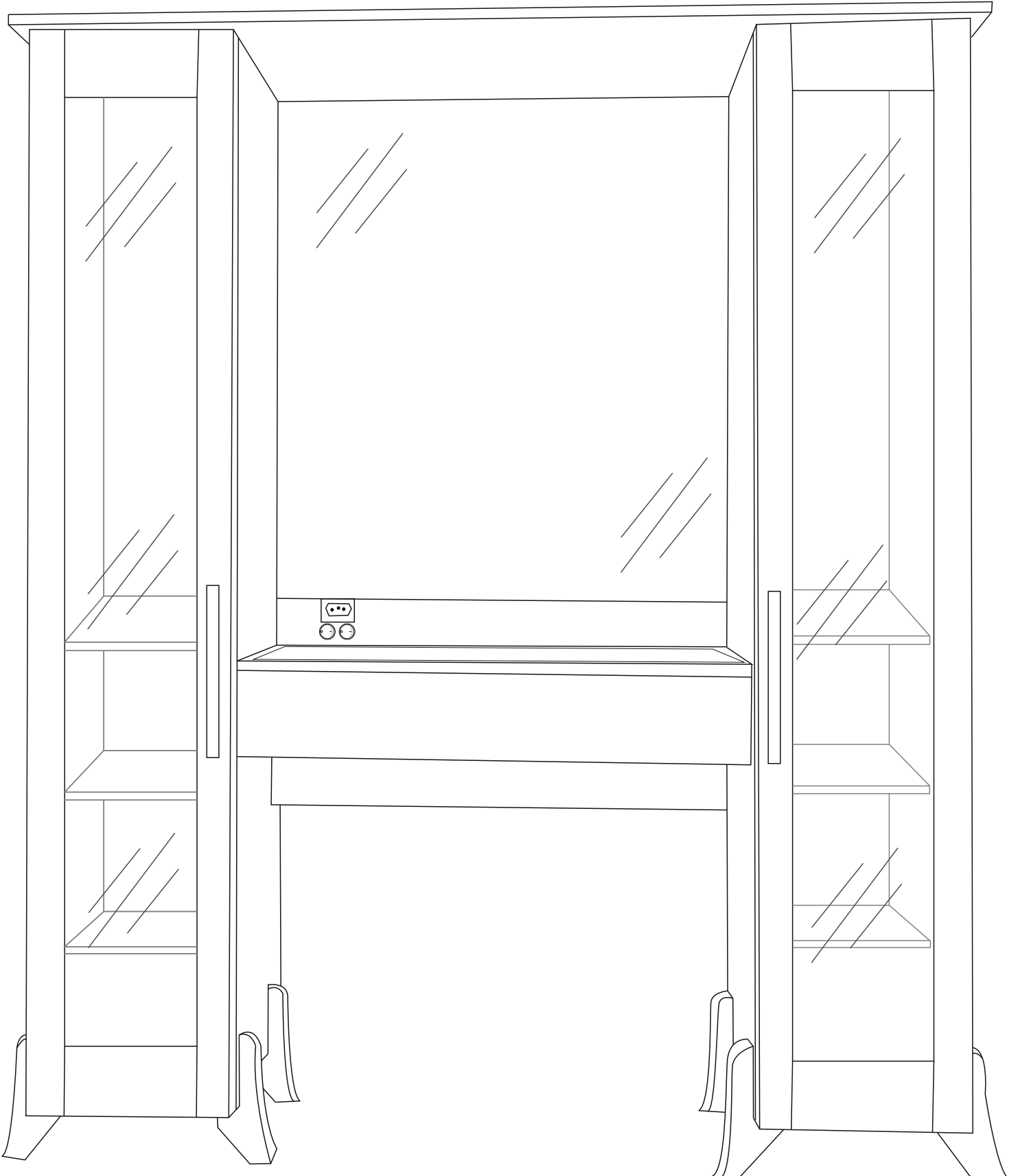













STAR

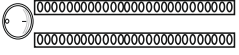

LEGENDA			DIMENSÃO								
Nº	QTD	DESCRIÇÃO	COMPR.	LARG.	ESP.						
01	1	TAMPO	1600 MM	430 MM	12 MM	14	1	LATERAL DE GAVETA (ESQUERDA)	387 MM	95 MM	12 MM
02	1	TRAVA	900 MM	40 MM	18 MM	15	1	CONTRA FUNDO DA GAVETA	851 MM	95 MM	12 MM
03	1	LATERAL DIREITA	1900 MM	450 MM	12 MM	16	1	FRENTE DE GAVETA	896 MM	147 MM	15 MM
04	1	LATERAL ESQUERDA	1900 MM	450 MM	12 MM	17	1	COLMEIA MAIOR	856 MM	60 MM	6 MM
05	2	BASE	448 MM	337 MM	12 MM	18	4	COLMEIA MENOR	374 MM	60 MM	6 MM
06	6	PRATELEIRA	420 MM	337 MM	12 MM	19	1	TRAVA DA GAVETA	374 MM	60 MM	12 MM
07	1	DIVISÓRIA DIREITA	1888 MM	450 MM	12 MM	20	1	FUNDO DA GAVETA	861 MM	384 MM	3 MM
08	1	DIVISÓRIA ESQUERDA	1888 MM	450 MM	12 MM	21	2	FUNDO TRASEIRO	1893 MM	345 MM	3 MM
09	1	TAMPO DO GAVETEIRO	900 MM	448 MM	18 MM	22	1	PAINEL TRASEIRO S/ TOMADA	547 MM	900 MM	12 MM
10	2	LATERAL PORTA (DOBRADIÇA)	1893 MM	59 MM	18 MM	23	1	TRAVA	900 MM	300 MM	12 MM
11	2	LATERAL PORTA (PUXADOR)	1893 MM	59 MM	18 MM	24	1	MOLDURA FRONTAL	1684 MM	90 MM	18 MM
12	4	TRAVESSA DA PORTA	233 MM	115 MM	15 MM	25	2	MOLDURA LATERAL	395 MM	90 MM	18 MM
13	1	LATERAL DE GAVETA (DIREITA)	387 MM	95 MM	12 MM	26	2	PUXADOR MDF	300 MM	30 MM	18 MM
						27	1	PAINEL TRASEIRO C/ TOMADA	547 MM	900 MM	12 MM

DICAS PARA LIMPEZA E CONSERVAÇÃO DO SEU MÓVEL:
NÃO USE PRODUTOS ABRASIVOS COMO ÁLCOOL, SOLVENTE, ACETONA, ETC...
USE SOMENTE UM PANO MACIO E SECO.

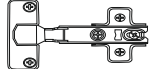
KIT ACESSÓRIOS

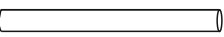
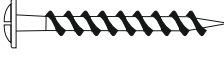
CÓD.	QTD	DESCRIÇÃO					
A	54	PARAFUSO 5,0 X 40 FLANG NA COR		J	1	CORREDIÇA TELESCÓPICA	
B	44	PARAFUSO 3,5 X 12 ZINC		K	4	SUORTE OBLONGO	
C	3	PARAFUSO 3,5 X 35 CH ZINC		L	1	ESPELHO	
D	4	PARAFUSO 7,0 X 35 SOB PHS NA COR		M	1	TOMADA	
E	4	PARAFUSO 7,0 X 35 TAMPA 13 NA COR		N	1	KIT LED MAIOR INTERNO	
F	22	PORCA CILÍNDRICA PLÁSTICA		O	1	KIT LED MENOR EXTERNO	
G	24	CAVILHA 06 X 30		P	8	PÉ EM MADEIRA	
H	24	PARAFUSO 3,5 X 35 FLANG NA COR		Q	6	DOBRADIÇA	
I	7	CONJUNTO MINIFIX		S	2	TUBO OBLONGO 330 MM	
				T	4	PARAFUSO 4,0 X 30 FLANG NA COR	

PASSO A PASSO:

PASSO 01:

FIXE AS PRATELEIRAS NA LATERAL

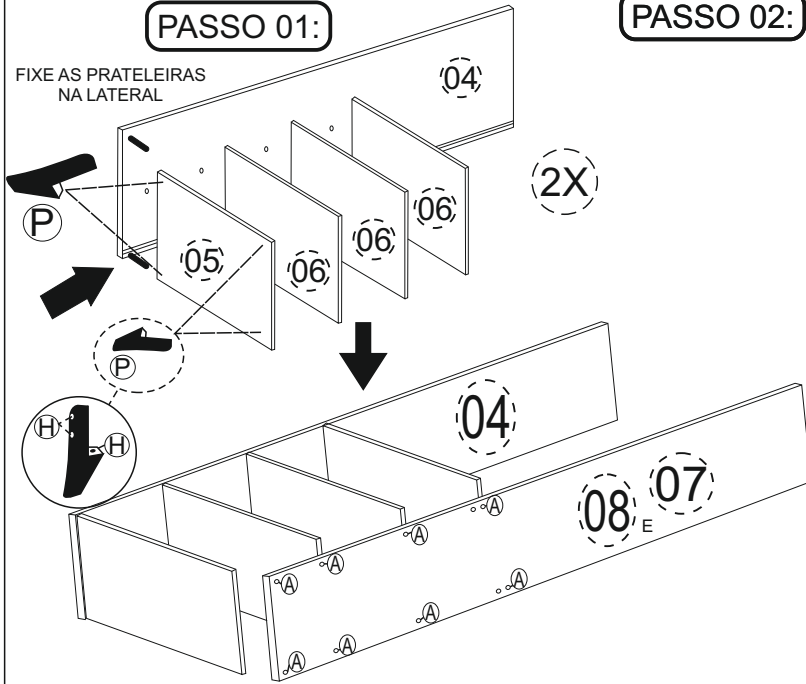

PASSO 02:

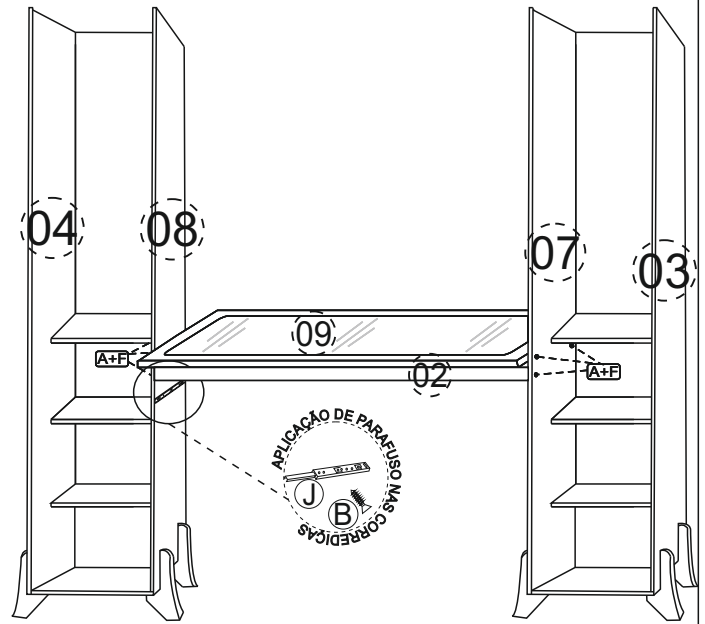

PASSO 03:

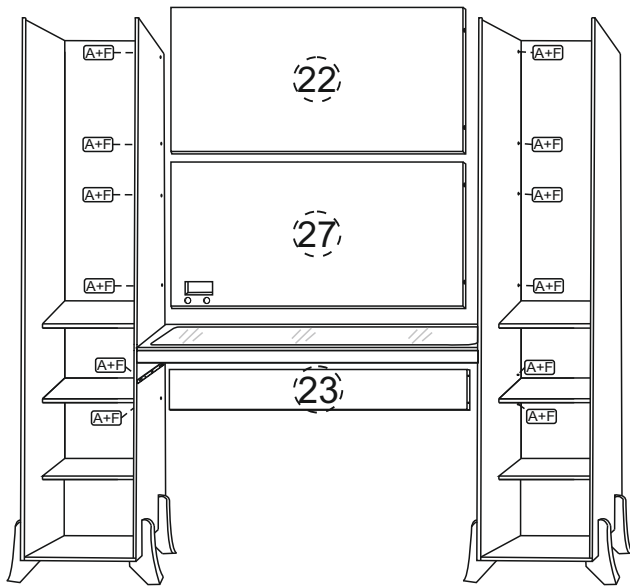

PASSO 04:

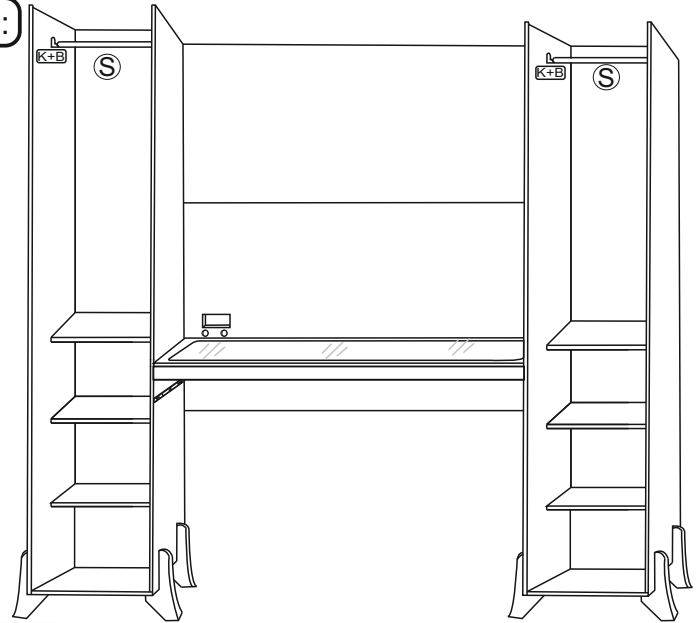

PASSO 05:

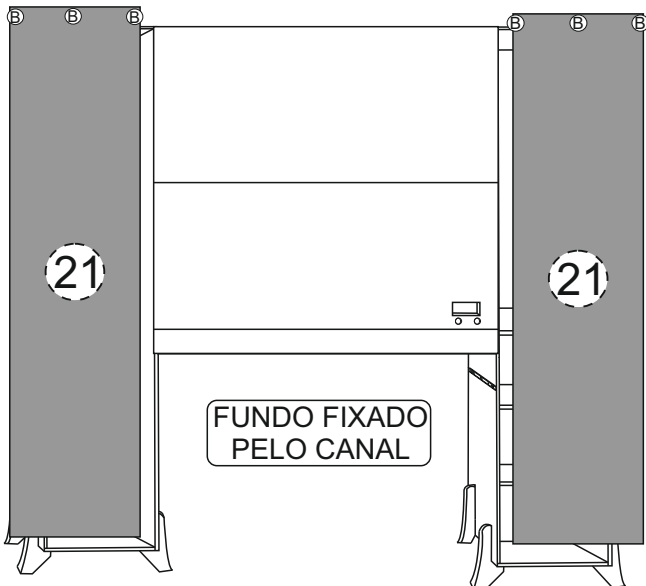

PASSO 06:

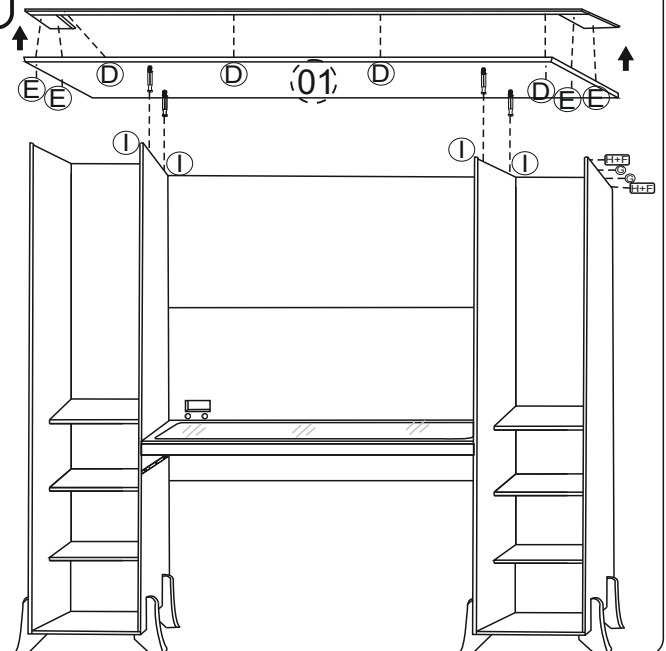

PASSO 07:

FIXE O ESPELHO DE CIMA PARA BAIXO COM DUPLA FACE

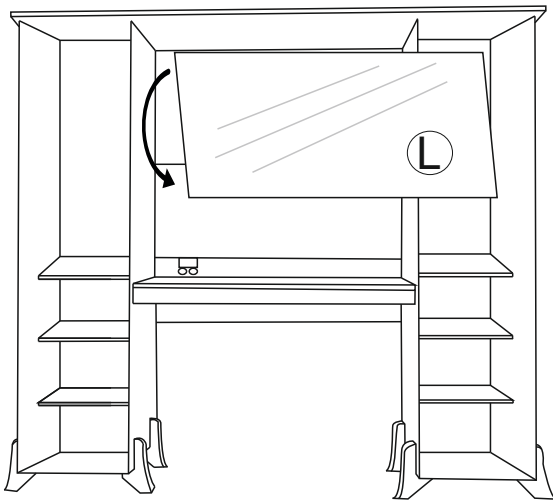

ATENÇÃO, ANTES DE FIXAR O ESPELHO, HIGIENIZE O PRODUTO PARA A MELHOR FIXAÇÃO

PASSO 08:

FURO PARA FIO LED

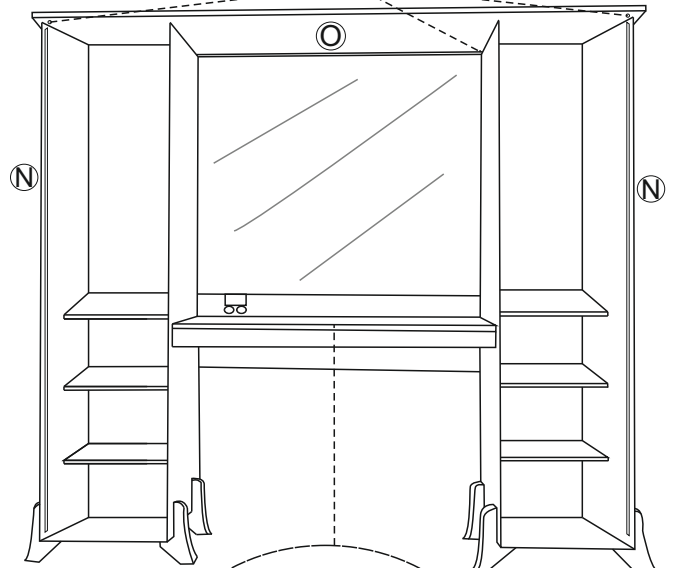

PARA A FIXAÇÃO DO LED DO GAVETEIRO, FIXE EMBAIXO DO TAMPO GAVETEIRO

FURO PARA FIO DO LED

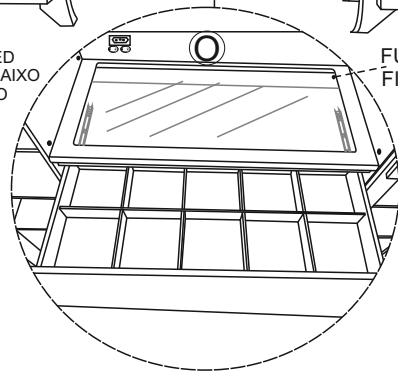

PASSO 09:

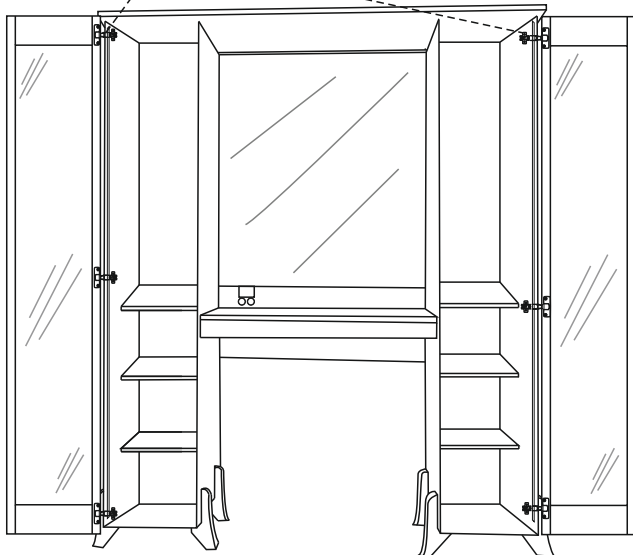
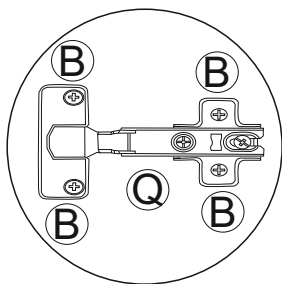

GAVETA:

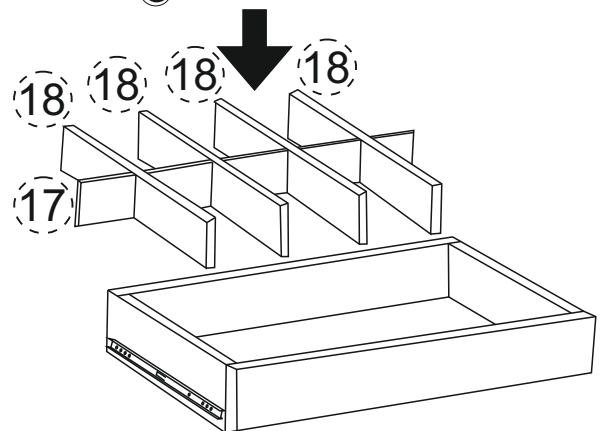
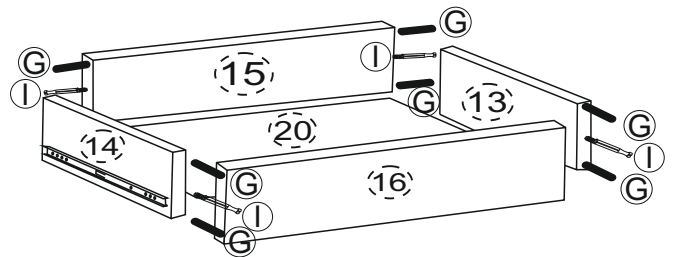

FUNDO DA GAVETA

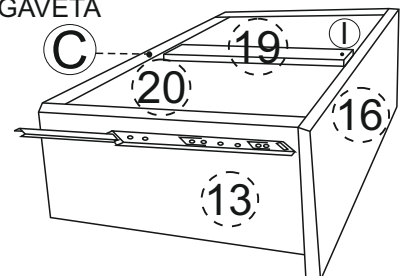

FIXAÇÃO DO PUXADOR

