

ESTANTE INDUSTRIAL 2 PORTAS SW017-NOC

Instruções de Montagem

Instrucciones de Montaje
Assembly's Instructions

PLACA&PONTO

LISTA DE PEÇAS / LISTA DE PIEZAS / FURNITURE PIECES LIST

REF	DESCRIÇÃO/DESCRIPCION/DESCRIPTION	DIMENSÃO/DIM/DIM	
01	Prateleira/ Estante/ Shelf	710x358x15	03
02	Lateral/ Lateral/ Side	1800x360x15	02
03	Porta/ Puerta/ Door	505X350X15	02
04	Tampo/ Tapa/ Top	710x358x15	01
05	Base/ Base/ Base	710x358x15	01
06	Costa/ Revés/ Back	706x245,5x3,0	02
07	Lateral/ Lado movable/ Movable side	470X358X15	02
08	Reforço/ Reforziamento/ Reinforcement	1725x1/8"x5/8"	01
09	Div Maior/ Div Mayor/ Longer Partition	680X348X15	01

Ferramentas Necessárias
Herramientas Necesarias
Necessary Tools













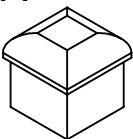

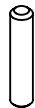

60 Min.

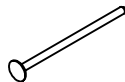

Martelo de Borracha
Rubber hammer
Martillo de goma



Parafusadeira
Screwdriver
Destornillador

A 04  Ponteira Tubo 15x15	B 25  PARAF. MAD CHIPBOARD 3.5 X 25 ZA	C 16  PARAF. MAD CHIPBOARD 3.5 X 14 ZA	D 02  PARAF. CAB. CHATA SEXT. INT. 1.4" X 20 ZP	E 07  Cavilha 30X06	F 01  Cola	G 20  Prego 10mm	
H 20  Ponteira Tubo	I 04  Dobradiça Lateral	J 04  Dobradiça Porta	K 03  Junção Fundo	L 04  Cantoneira 13X13	M 04  PARAF. MAD CHIPBOARD 3.5 X 40 ZA	N 01  CHAVE ALLEN 4mm DUPLA	O 02  ARRUELA PRESSAO 5-16" ZP

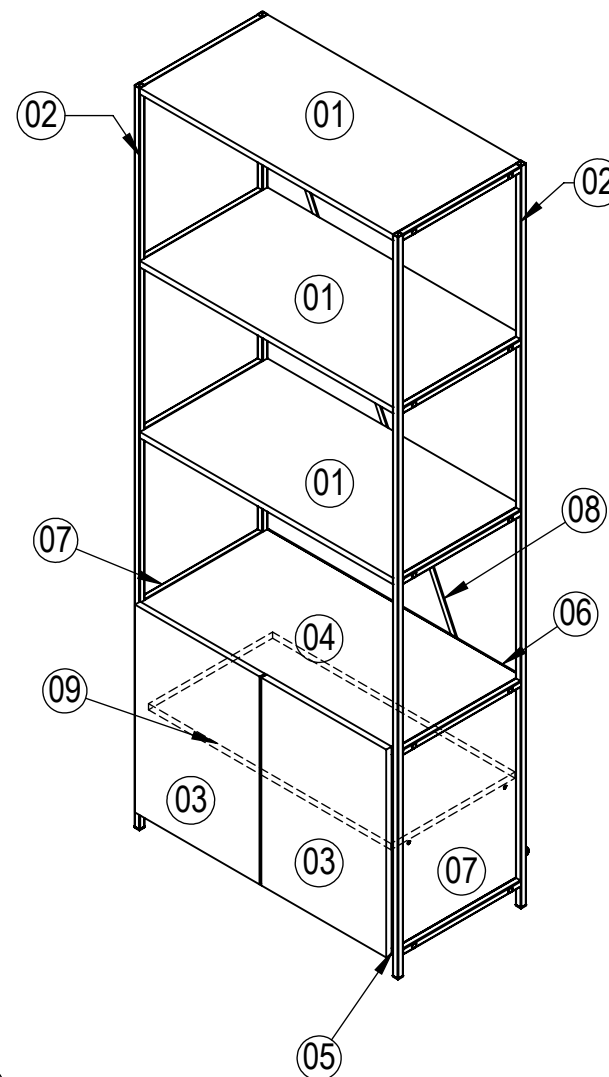

ESTANTE INDUSTRIAL 2 PORTAS

SW017-NOC

Instruções de Montagem

Instrucciones de Montaje
Assembly's Instructions



RECOMENDAÇÕES:

- 01 - Examine completamente todas as peças do móvel antes de iniciar o trabalho.
- 02 - Recomenda-se montar o móvel conforme este Manual de Montagem.
- 03 - É de responsabilidade do montador seguir as instruções do Manual de Montagem, que são fundamentais para garantir a estrutura do móvel.
- 04 - Certifique-se de que todos os acessórios utilizados na montagem (parafusos, porcas, ponteiras) estejam fixados o suficiente, totalmente atarraxados, evitando que venham a provocar ferimentos.

LIMPEZA:

- 01 - Pano levemente umedecido com água, seguido de pano seco.
- 02 - Não utilizar produtos químicos ou abrasivos.

GARANTIA:

- 01 - 3 meses para defeitos ou vícios de origem.

ADVERTÊNCIAS:

- 01 - Esteja ciente do risco de chama aberta e outras fontes de calor, tais como aquecedores elétricos, aquecedores a gás etc. nas proximidades do produto.
- 02 - Não utilize o produto se alguma parte estiver quebrada, rasgada ou faltando. Utilizar somente peças de reposição aprovadas pelo fabricante.

RECOMENDACIONES:

- 01 - Examine completamente todas las piezas del mueble antes de empezar el montaje.
- 02 - Recomienda-se montar el mueble de acuerdo con este Manual de Montaje.
- 03 - Es de responsabilidad del montador seguir las instrucciones del Manual de Montaje, que son fundamentales para asegurar la estructura del mueble.
- 04 - Asegure-se de que todos los accesorios utilizados en el montaje (tornillos, tuercas, ponteras) estén fijados el suficiente, totalmente roscados, evitando que vengam a provocar lesiones.

LIMPIEZA:

- 01 - Paño levemente humedecido con agua, siguiendo de paño seco.
- 02 - No utilizar productos químicos o abrasivos.

GARANTÍA:

- 01 - 3 meses para defectos o vicios de origen.

ADVERTENCIAS:

- 01 - Tenga en cuenta el riesgo de llama abierta y otras fuentes de calor, tales como calentadores eléctricos, calentadores de gas, etc. en las proximidades del producto.
- 02 - No utilice el producto si alguna parte esté rota, o perdida. Utilizar sólo piezas de repuesto aprobadas por el fabricante.

RECOMENDATIONS:

- 01 - Check completely all the furniture's pieces before start to assemble it.
- 02 - It is recommended to assemble this furniture according to this Assembly's Manual.
- 03 - It is the assembler's responsibility to follow the instructions of this Assembly's Manual, which are essential to ensure the furniture's structure.
- 04 - Ensure that all the accessories used in the assembly (bolts, nuts, tips) are well and enoughly fixed, completely threaded, avoiding injuries from happening.

CLEANSING:

- 01 - Cloth slightly moistened with water.
- 02 - Do not use chemicals or abrasives products.

WARRANTY:

- 01 - 3 months due to manufacture defects.

WARNINGS:

- 01 - Be aware of the risk of open flame and other sources of heat, such as electric heaters, gas heaters etc. around the product.
- 02 - Do not use the product if any part is broken, torn or missing. Only use replacement parts approved by the manufacturer.