

**Manual de Montagem, Instalação e Uso do Produto**

**ARTEMOBILI**  
móveis com encaixe perfeito

# **Nicho Redondo 2 Prateleiras**

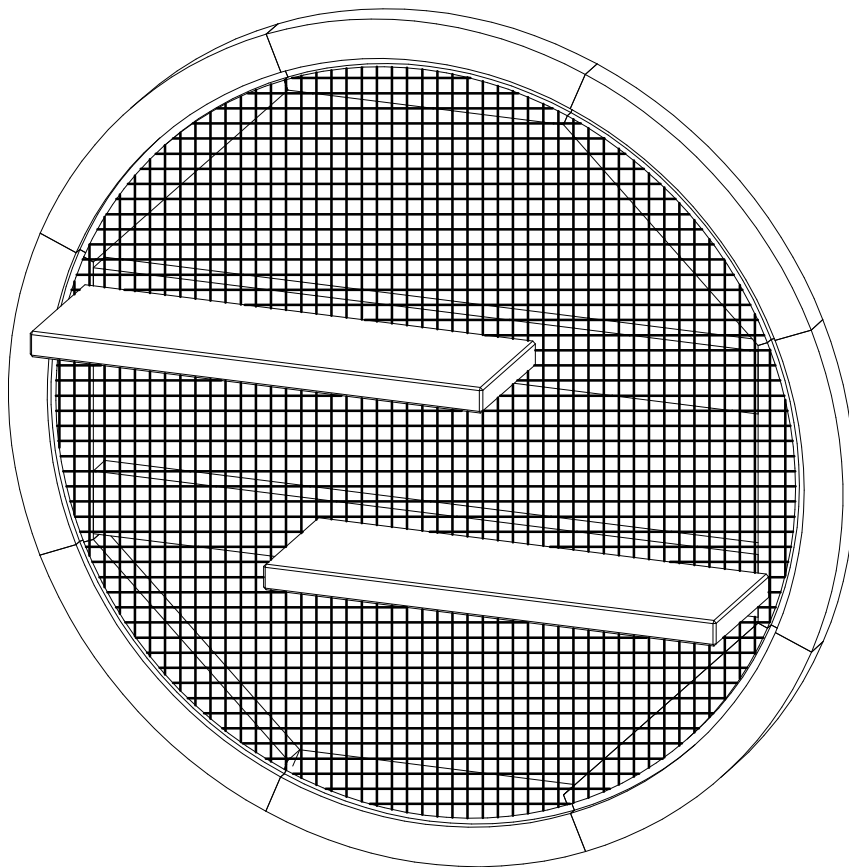

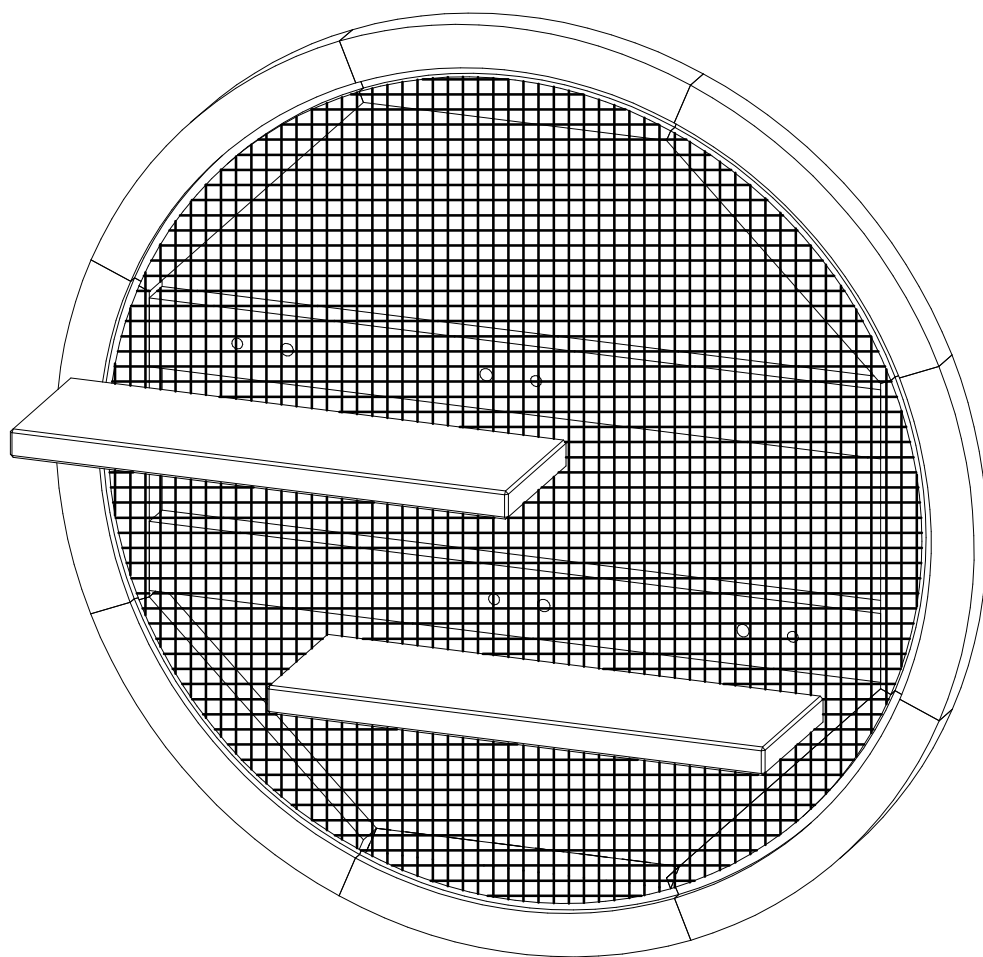

1	(1x)	590 x 590 x 22
2	(2x)	320 x 100 x 18

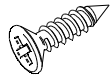
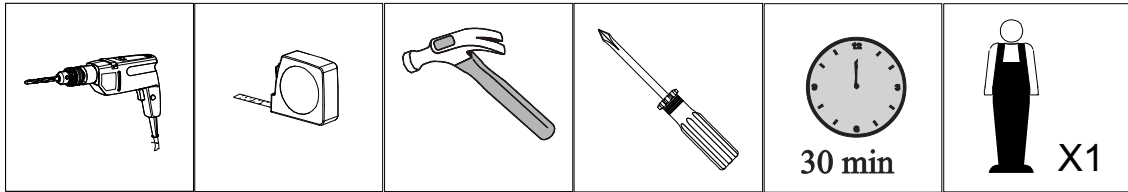

B - 3,5x16 - 4x

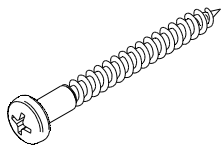

C - 4x40 - 2x

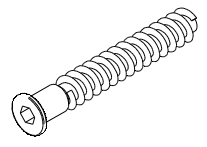

D - 7x50 - 4x

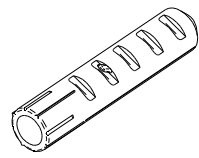

E - 2x

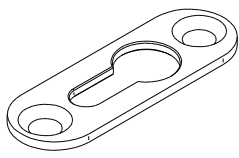

F - 2x

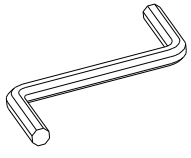

G - 1x

**1**

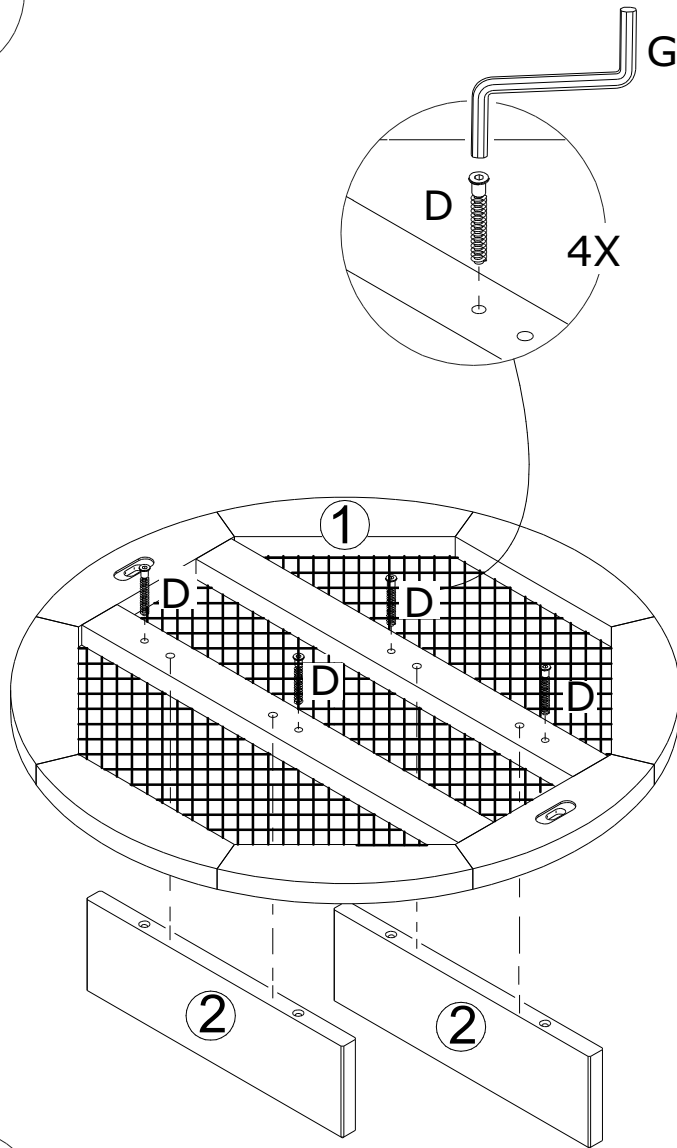
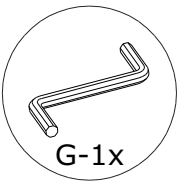
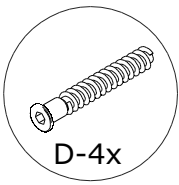

**2**

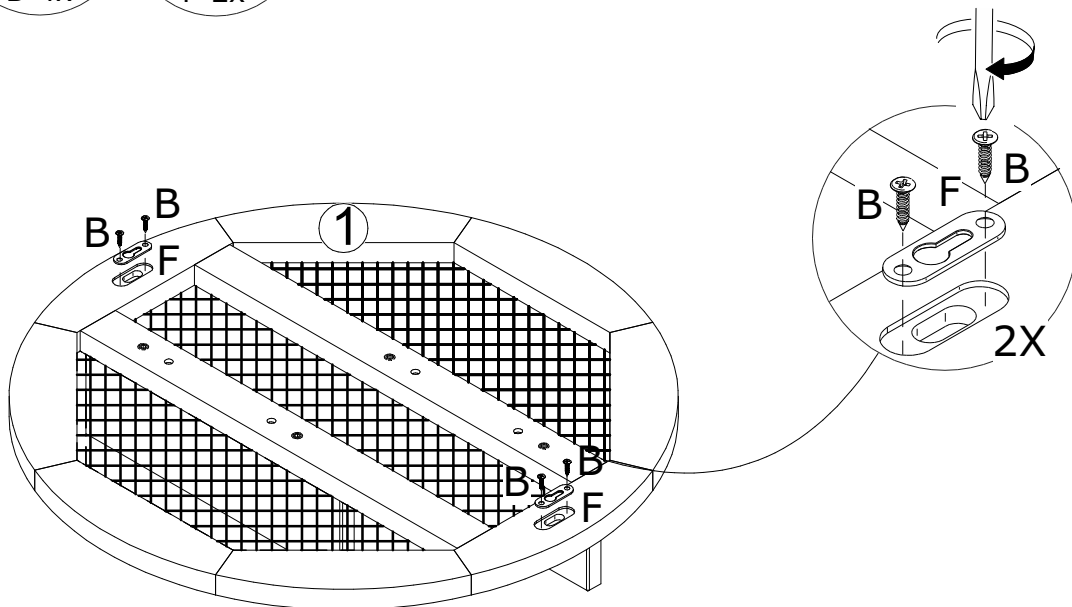
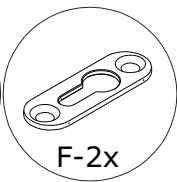
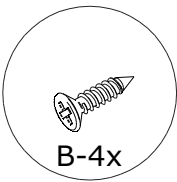

**3**

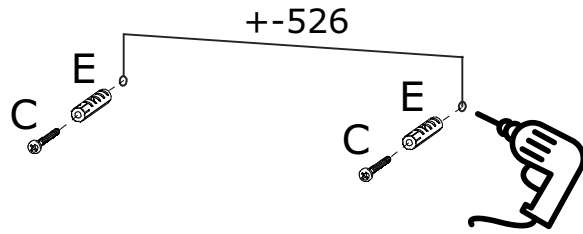
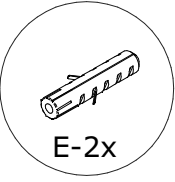
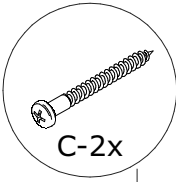

**4**

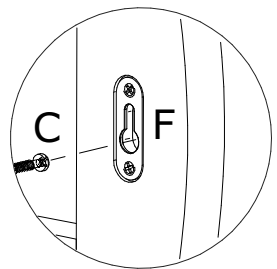
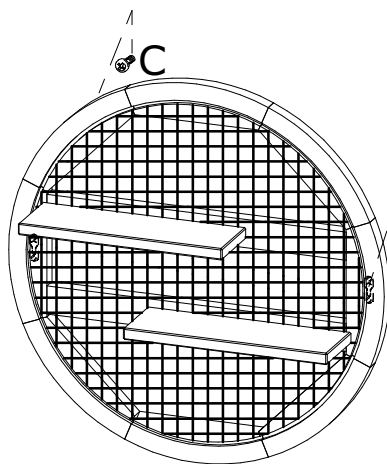

**5**

**5**

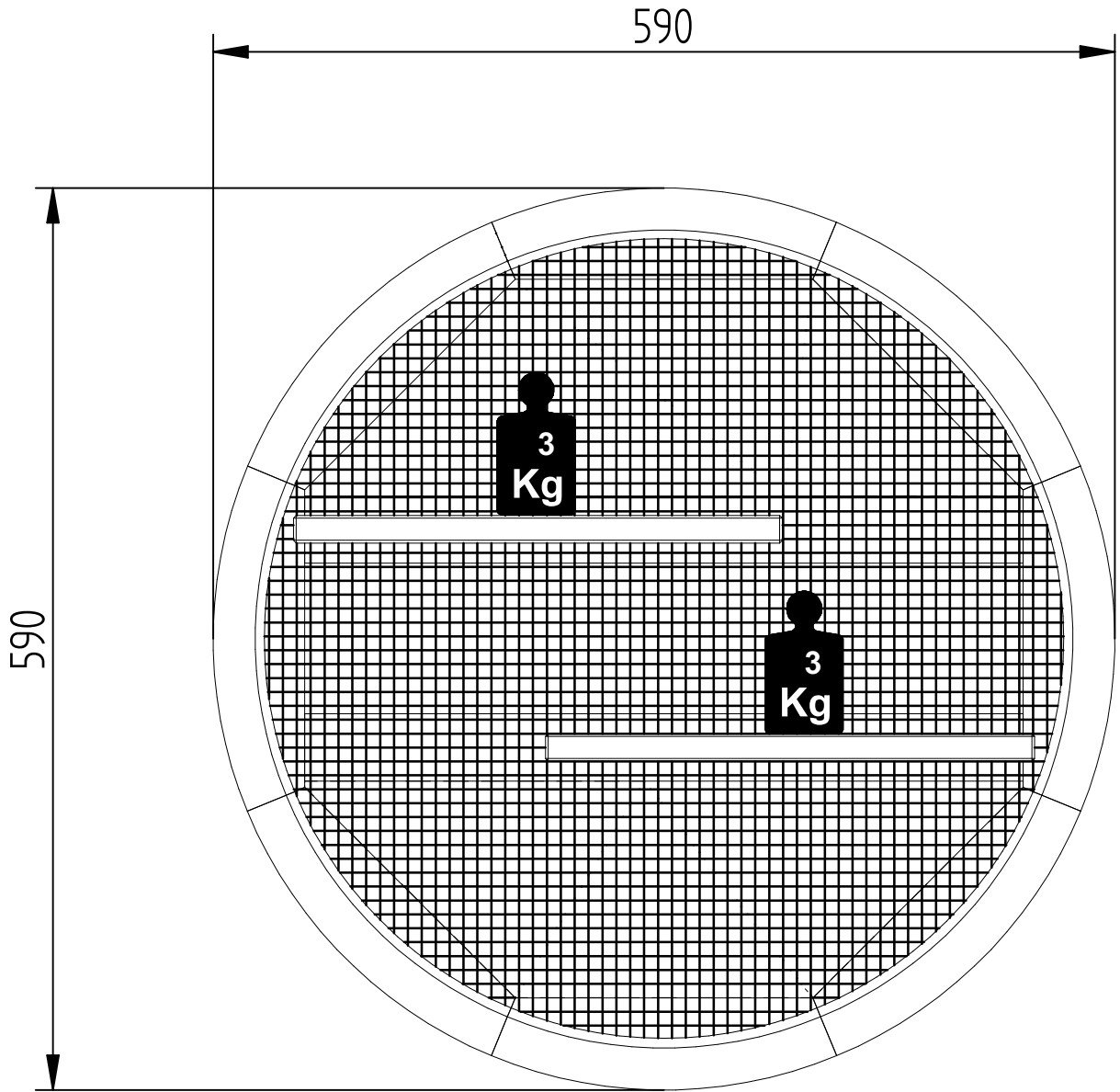

## **Cuidados com o produto**

### **Nicho Redondo 2 Prateleiras**

Com o intuito de garantir a sua satisfação e confirmar o nosso compromisso com a qualidade, queremos que leia atentamente nossas recomendações para o cuidado do seu móvel.

1. Proteja-o da incidência direta da luz solar.
2. Evite coloca-lo próximo de estufas ou saídas de ar condicionado.
3. Não deixe em lugar úmido e ambientes com muito pó.
4. Evite objetos pontiagudos sobre a superfície.
5. Para limpeza deste produto, use apenas um pano macio, umedecido com água e sabão neutro.
6. Não use álcool, detergentes, abrasivos, etc...
7. A montagem deverá obedecer as instruções do manual, a montagem efetuada de maneira incorreta acarreta na perda de garantia.
8. Em caso de mudança de endereço possíveis avarias no transporte perderão a garantia.
9. Aperte os parafusos periodicamente.

**IMPORTANTE:** todas não conformidades deverão ser apontadas no momento do recebimento do produto.

### **Garantia Legal.**

## Cuidados con el mueble

Con la intención de garantizar su satisfacción y de acuerdo con nuestro compromiso de calidad, queremos que el Sr, Sra, lean atentamente nuestras instrucciones con el cuidado de su mueble.

1. Protéjalo de la luz directa del sol.
2. Evite colocarlo próximo de estufas o salidas de aire acondicionado.
3. No deje en lugar húmedo y o ambientes con mucho polvo.
4. Evite objetos puntiagudos sobre su superficie.
5. Para la limpieza de este producto, use solamente un paño suave, húmedo con agua y
6. No use alcohol, detergentes, abrasivos, etc...

perdida de la garantía.

8. En caso de mudanza a otra dirección posibles daño en el transporte perderán la garantía.
9. Aprete los tornillos periódicamente.

**IMPORTANTE:** todas no conformidades deverão ser anotadas en el momento de recibir el producto.

### **Garantía Legal.**



## Take Care of Your Furniture

In order to ensure your satisfaction and confirm our commitment with quality, we want you to carefully read our recommendations for the care of your furniture.

1. Protect it from direct sunlight.
2. Avoid placing it near greenhouses or air conditioning vents.
3. Do not leave in a humid place and environments with a lot of dust.
4. Avoid sharp objects on the surface.
5. To clean this product, use only a soft cloth, moistened with mild soap and water.
6. Do not use alcohol, detergents, abrasives, etc...
7. The assembly must obey the instructions in the manual, the incorrectly assemble results in the loss of warranty.
8. In case of change of address, possible damage in transport will lose the warranty.
9. Tighten the screws periodically.

**IMPORTANT:** all conformities must be noted at the time of receive the product.

### **Legal Guarantee.**