

Instruções de instalação

O saco plástico contém os seguintes componentes para a correta fixação:

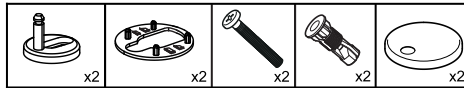

1 Efetue a instalação conforme sequência, não efetuar o aperto de forma definitiva;

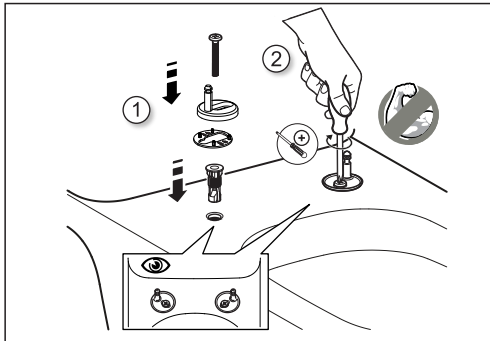

2 Encaixe o assento no pino guia;

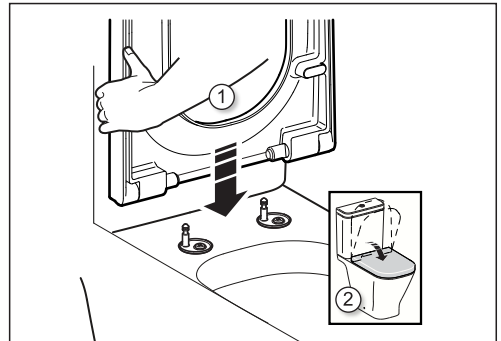

3 Se necessário, efetue o ajuste do assento;

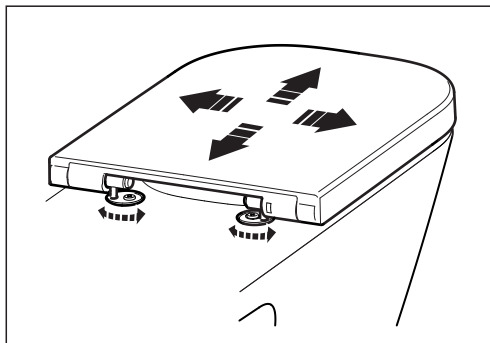

4 Retire o assento, para realizar o aperto definitivo dos parafusos;

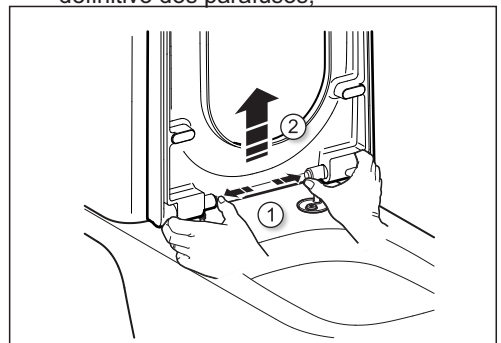

5 Efetue o aperto definitivo dos parafusos;

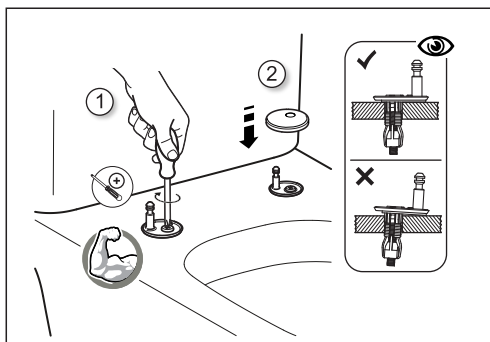

6 Encaixe definitivamente o assento;

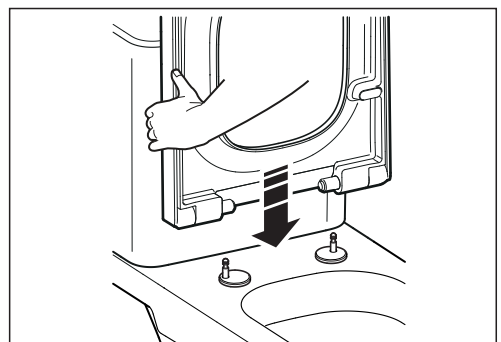

Instruções para limpeza

Para efetuar a limpeza, se necessário solte o assento conforme figuras abaixo, e utilize um pano macio úmido com água e sabão neutro, após isso enxaguar ou remover o sabão com pano macio e água;

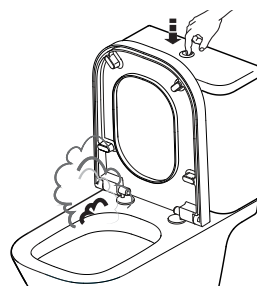
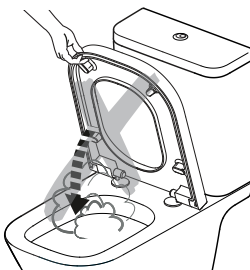
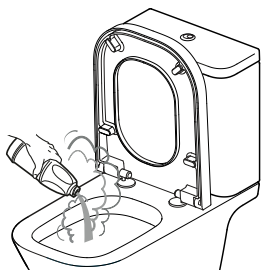
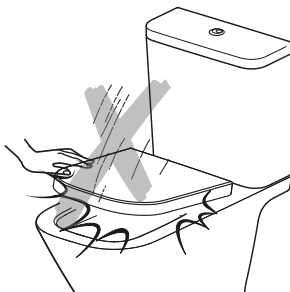
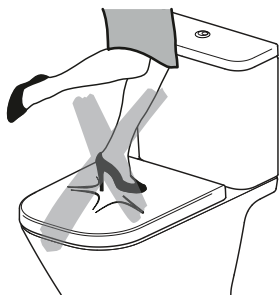
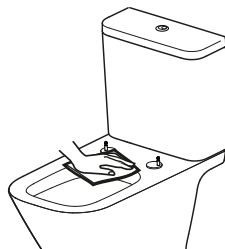
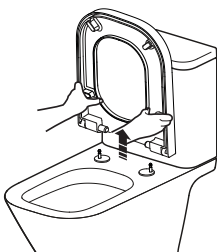
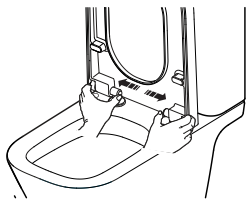

ATENÇÃO: Nunca utilize produtos químicos, Solventes ou abrasivos para limpar o assento.

Incepa Celite

Av. 14 de Dezembro, 2.800 | V. Mafalda
Jundiaí | CEP 13206-105 | SP | Brasil
CNPJ 75.801.902/0001-26
IE 407.489.471.115

CONSULTE O TERMO DE GARANTIA
WWW.INCEPA.COM.BR

CONSULTE O TERMO DE GARANTIA
WWW.CELITE.COM.BR



ASSISTÊNCIA TÉCNICA
0800 70 11 300
POSVENDAS@BR.ROCA.COM