



ARMÁRIO MULTIUSO PRISMA
Código 7678

Benetil
Móveis

Av. Jesus Candian, 395 - B. Mangueira Rural
Telefax (32) 3539-5350
CEP 36500-000 - Ubá - Minas Gerais
www.benetil.com.br

RELAÇÃO DE FERRAGENS EM TAMANHO REAL (MEDIDA EM MILÍMETRO).

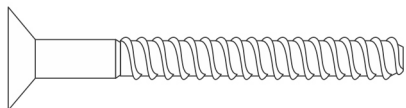

A - PARAF. 5,0x40

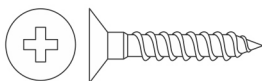

B - PARAF. 4,0x25



C - PARAF. 3,5x14



D - PREGO 8x8

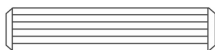

E - CAVILHA 6x30



F - RODÍZIO



G - PUXADOR

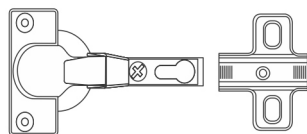

H - DOBRADIÇA / CALÇO

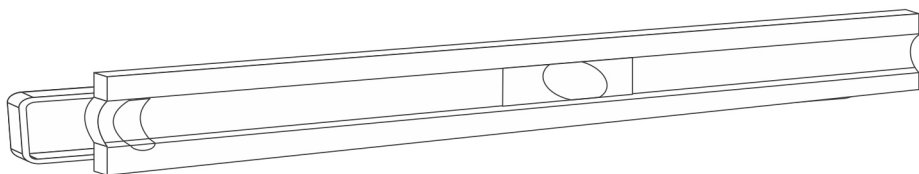

I - CORREDIÇA TELESCÓPICA



J - CANTONEIRA 4 FUROS

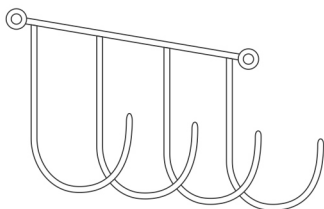

K - SUPORTE VASSOURA

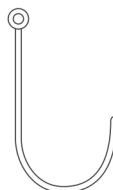

L - SUPORTE VASSOURA INDIVIDUAL

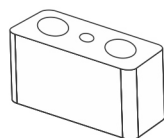

M - ALONGADOR DE CORREDIÇA



N - PARAF. 4,0x20



FAVOR IDENTIFICAR AS PEÇAS E COLOCAR SEUS RESPECTIVOS ACESSÓRIOS

**ATENÇÃO: MONTAR COM
O MÓVEL DEITADO.**

Sequência de Montagem

- 01 - Comece a montagem pela peça 5;
- 02 - Parafusar as peças 6 na peça 5;
- 03 - Parafusar a peça 7 nas peças 6

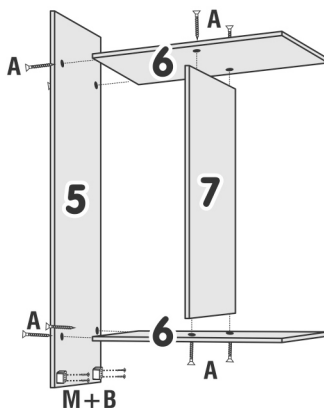
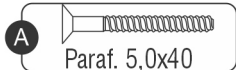

**ATENÇÃO: MONTAR COM
O MÓVEL DEITADO.**

Sequência de Montagem

- 04 - Parafusar a peça 4 na peça 5.

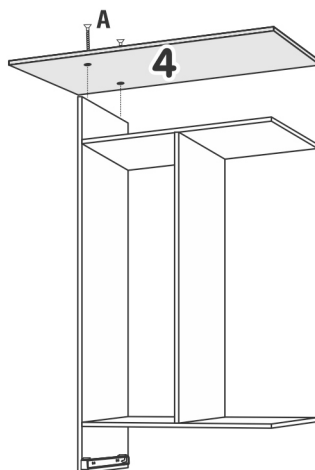

**ATENÇÃO: MONTAR COM
O MÓVEL DEITADO.**

Sequência de Montagem

05 - Parafusar as peças 8 nas
peças 5 e 7;

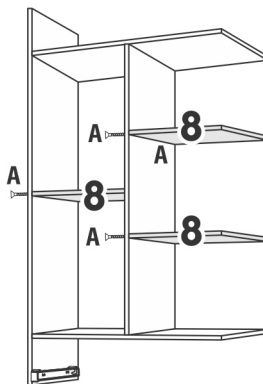

**ATENÇÃO: MONTAR COM
O MÓVEL DEITADO.**

Sequência de Montagem

06 - Parafusar a peças 2 na
peça 4

07 - Parafusar a peça 3 nas
peças 4, 6 e 8;

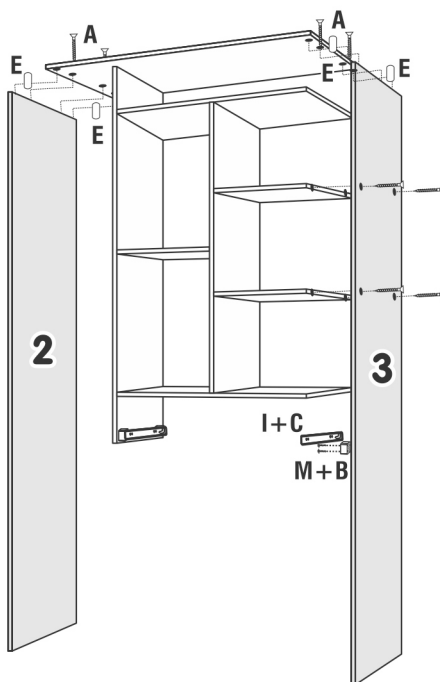
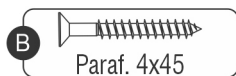

**ATENÇÃO: MONTAR COM
O MÓVEL DEITADO.**

Sequência de Montagem

08 - Encaixar e Parafusar a
peça 1 nas peças 2 e 3.

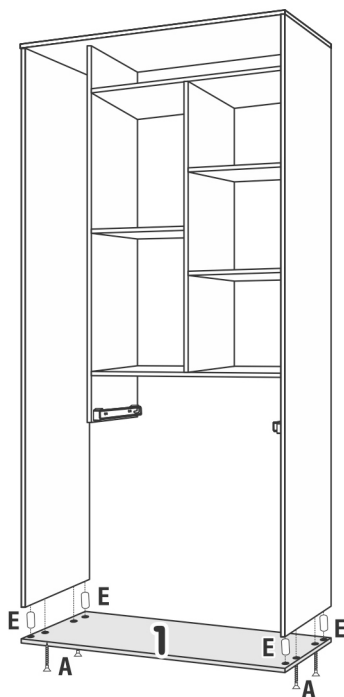

**ATENÇÃO: MONTAR COM
O MÓVEL DEITADO.**

Sequência de Montagem

09 - Parafusar os rodízios (F)
na base 1.

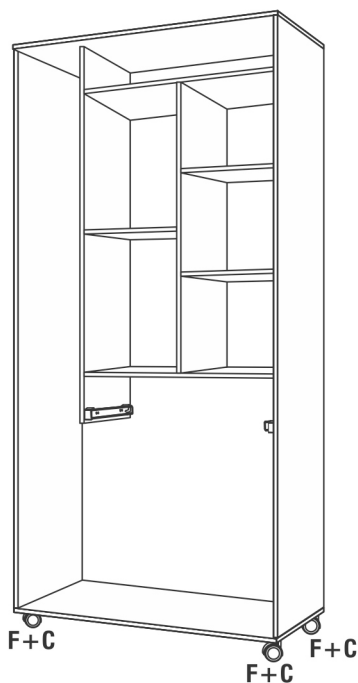

Sequência de Montagem

10 - Montar as portas conforme desenho ao lado;

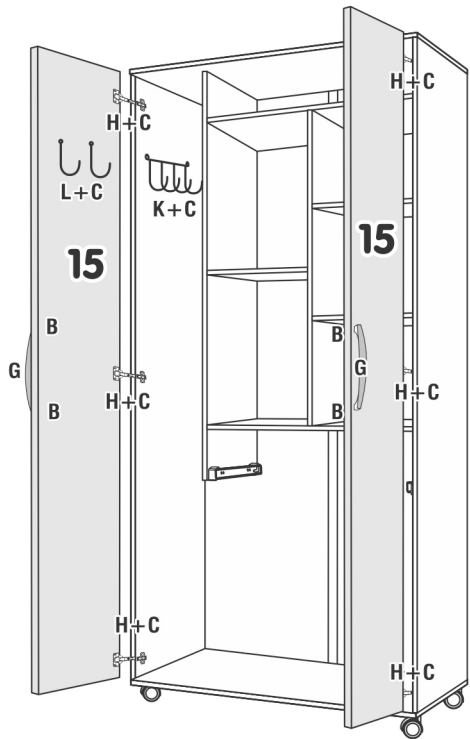
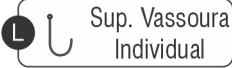

Sequência de Montagem

11 - Unir as costas 12 com Perfil H 14 e pregar as mesmas conforme o desenho ao lado.

OBS.: Acertar as costas para melhor esquadrejamento do móvel, na prateleira 02 é necessário pregar os pregos a cada 5cm para reforçar o produto.

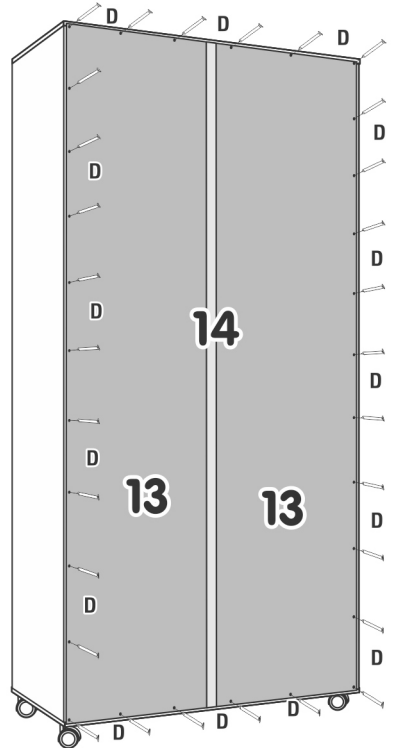

7

Sequência de Montagem

- 12 - Parafusar as cantoneiras nas peças 10;
- 13 - Encaixar e Parafusar as peças 10 na peça 9;
- 14 - Parafusar a peça 11 nas peças 10;
- 15 - Parafusar peça 12 nas peças 10 e 11 conforme desenho abaixo, ajustando para melhor esquadrejamento da gaveta;
- 16 - Parafusar as corredeiras na lateral da peça 10;

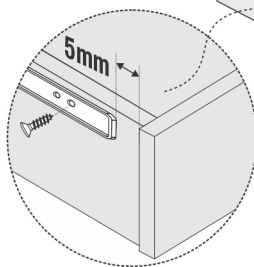
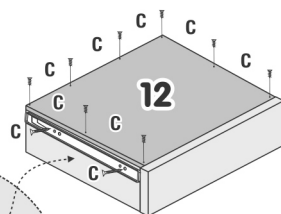
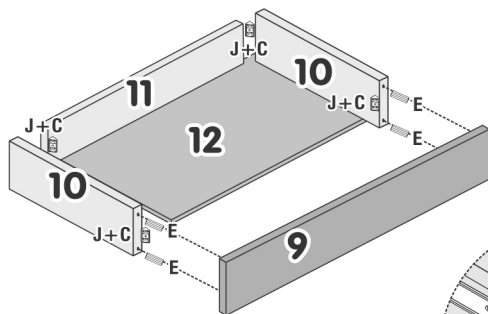

Benetil

Móveis

Av. Jesus Candian, 395 - B. Mangueira Rural

Telefax (32) 3539-5350

CEP 36500-000 - Ubá - Minas Gerais

www.benetil.com.br