



***ROUPEIRO MASTER 06 PTS***

***Código: ????***

***Benetil***  
Móveis

Av. Jesus Candian, 395 - B. Mangueira Rural

**Telefax (32) 3539-5350**

CEP 36500-000 - Ubá - Minas Gerais

[www.benetil.com.br](http://www.benetil.com.br)

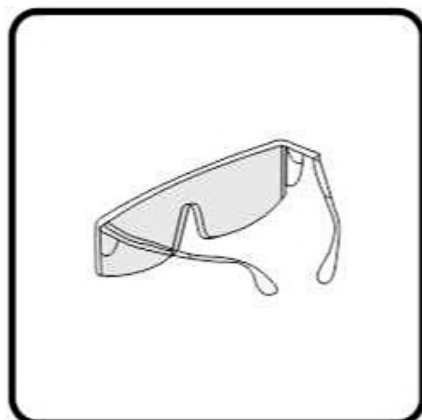
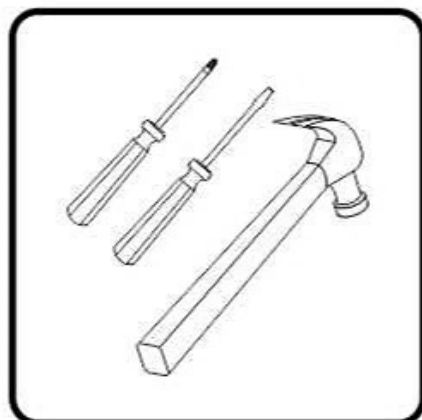

## DETALHES IMPORTANTES

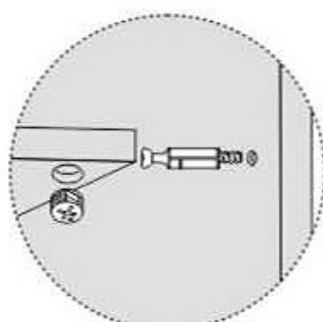

Minifix

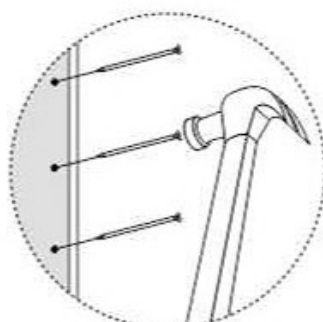

Costas Pregadas



Corrediça Telecópica

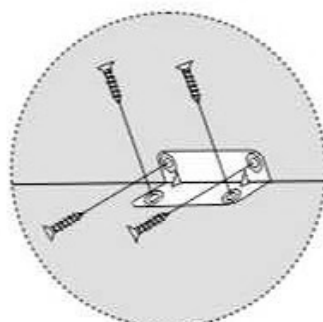

Cantoneira 4 Furos

**ATENÇÃO: EM CASO DE ASSISTÊNCIA, VERIFICAR O NÚMERO DO LOTE DE PRODUÇÃO, NO TOPO DAS PEÇAS E NA ETIQUETA DA CAIXA DO PRODUTO.**

**RESERVAMO-NOS O DIREITO DE EFETUAR MODIFICAÇÕES TÉCNICAS OU DE MATERIAIS SEM PRÉVIO AVISO.**

| RELAÇÃO DE FERRAGENS |   |                        | COMPONENTES |                             |        |
|----------------------|---|------------------------|-------------|-----------------------------|--------|
| CÓD.                 | DESENHO   | NOME                   | NUM.        | PEÇA                        | QUANT. |
| A                    |    | PARAF. 3,5x14          | 01          | LATERAL ESQUERDA            | 01     |
| B                    |    | PARAF. 4,5x50          | 02          | RODAPÉ MAIOR                | 02     |
| C                    |    | PARAF. 4x25            | 03          | RODAPÉ MENOR                | 02     |
| D                    |    | PARAF. 4x35            | 04          | LATERAL DIREITA             | 01     |
| E                    |    | CANTONEIRA 4 FUROS     | 05          | PÉ                          | 08     |
| F                    |    | SACHÊ DE COLA          | 06          | BASE                        | 01     |
| G                    |    | MINIFIX SIMPLES        | 07          | DIVISÕES                    | 02     |
| H                    |    | FIXADOR DE COSTAS      | 08          | PRATELEIRA GAVETEIRO        | 02     |
| I                    |    | TAMBOR                 | 09          | PRATELEIRA CENTRAL INFERIOR | 01     |
| J                    |    | TAMPINHA ADESIVA       | 10          | PRATELEIRA CENTRAL SUPERIOR | 01     |
| L                    |   | CORRED. TELESCÓPICA    | 11          | DIVISÃO DO NINCHO           | 01     |
| M                    |  | PUXADOR                | 12          | PRAT. NINCHO                | 02     |
| N                    |  | CANT. PLÁSTICA 4 FUROS | 13          | TAMPO INTERMEDIÁRIO         | 01     |
| O                    |  | SUPORTE CABIDEIRO      | 14          | DIVISÃO DO MALEIRO          | 02     |
| P                    |  | CABIDEIRO              | 15          | TAMPO SUPERIOR              | 01     |
| Q                    |  | CAVIHA 6x30            | 16          | VISTA SUPERIOR              | 01     |
| R                    |  | PREGO 10x10            | 17          | SUPORTE CORREDIÇA           | 08     |
| S                    |  | PREGO 13x15            | 18          | FRENTE GAVETA               | 04     |
| T                    |  | DOBRADIÇA PRESSÃO      | 19          | LATERAIS GAVETA             | 08     |
| U                    |  | CALÇO                  | 20          | TRASEIRO GAVETA             | 04     |
|                      |   |                        | 21          | FUNDOS DE GAVETA            | 04     |
|                      |   |                        | 22          | COSTAS (HORIZONTAL)         | 05     |
|                      |   |                        | 23          | PERFIL H                    | 04     |
|                      |   |                        | 24          | PORTAS                      | 06     |
|                      |   |                        |             |                             |        |
|                      |   |                        |             |                             |        |
|                      |   |                        |             |                             |        |
|                      |   |                        |             |                             |        |
|                      |   |                        |             |                             |        |
|                      |   |                        |             |                             |        |

# FAVOR IDENTIFICAR AS PEÇAS E COLOCAR SEUS RESPECTIVOS ACESSÓRIOS

## Sequência de Montagem

- 01 - Parafusar peças 1 na peça 2.
- 02 - Parafusar peças 3 nos rodapés 2  
Observação: Seguir a furação que vai em cima do rodapé 2 para colocação do rodapé 03 tem que ficar alinhado.
- 03 - Parafusar peça 4 nas peças 2;
- 04 - Parafusar os Pés 5 nos rodapés 2.

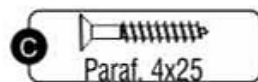
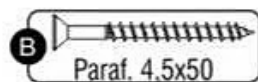
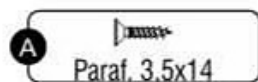

ATENÇÃO COM OS FUROS NA PARTE SUPERIOR DA PEÇA 2 AS PEÇAS 3 TEM QUE ALINHADOS COM OS MESMOS.



ATENÇÃO CASO OPTE PELA COLOCAÇÃO DOS PÉS QUE SÃO VENDIDOS SEPARADAMENTE VER O DESENHO PAGINA 08.

## Sequência de Montagem

- 05- Encaixar e Parafuse peça 6 nos rodapés 2 e laterais 1 e 4.
- 06- Encaixar e parafusar peças 7 na peça 6.
- 07- Parafusar peças 8 nas peças 7, 1 e 4.

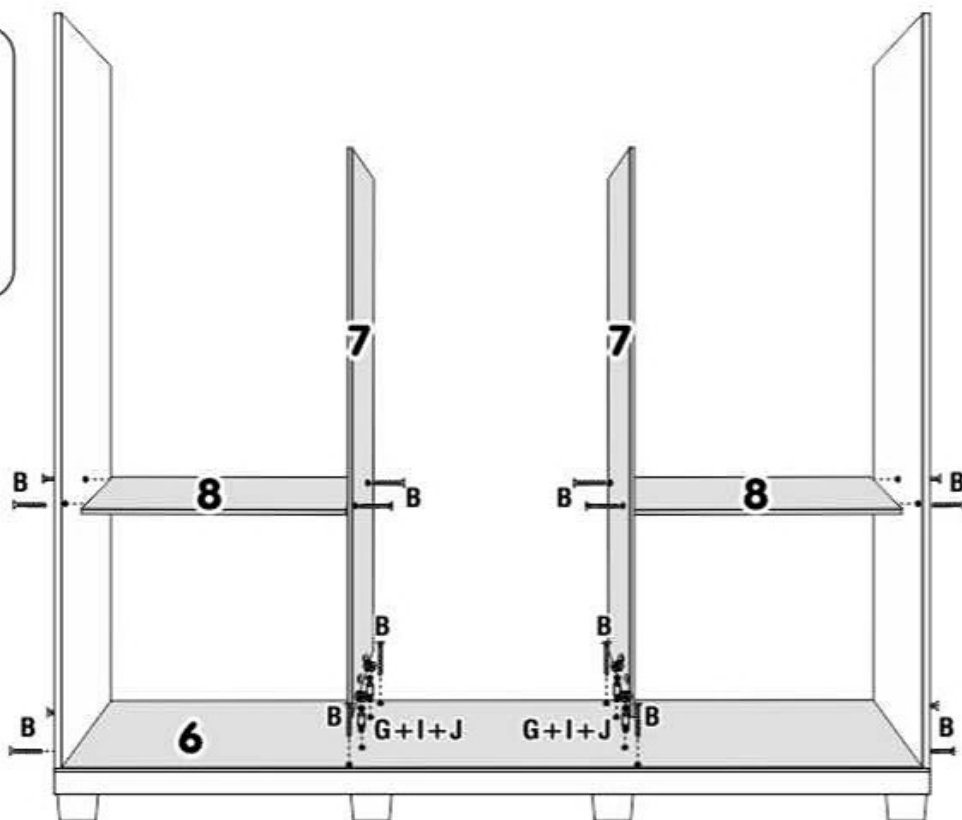
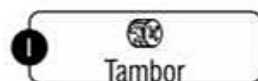
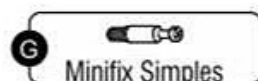
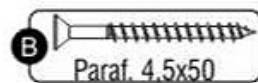

## Sequência de Montagem

- 08 - Encaixar e fixar peça 9 e 10 nas peças 7;  
 09 - Parafusar a peça 13 nas peças 1 e 4 em seguida parafusá-la nas peças 7;  
 10 - Parafusar peça 11 nas peças 10 e 13;  
 11 - Fixar as Peças 12 nas peças 7 e 11.

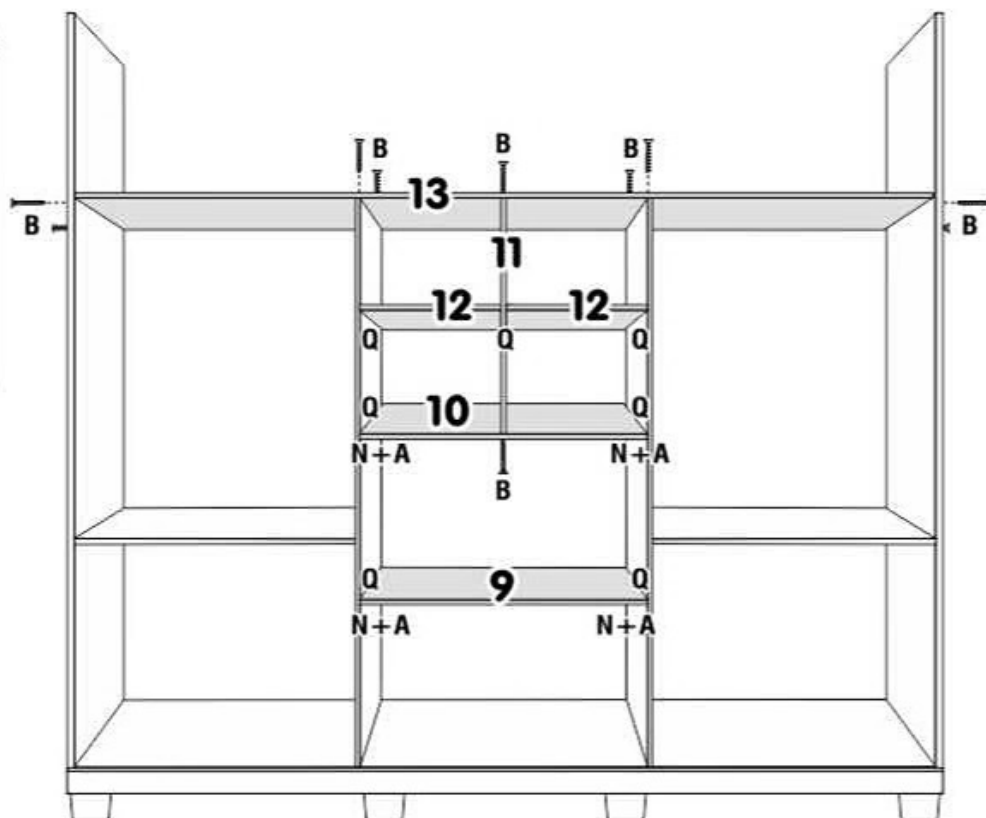
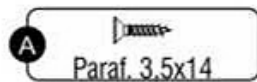

## Sequência de Montagem

- 12 - Fixar e parafusar peças 14 na peça 13.  
 13 - Encaixar e parafusar peça 15 na peças 01 e 04 e depois parafusá-la nas peças 14.

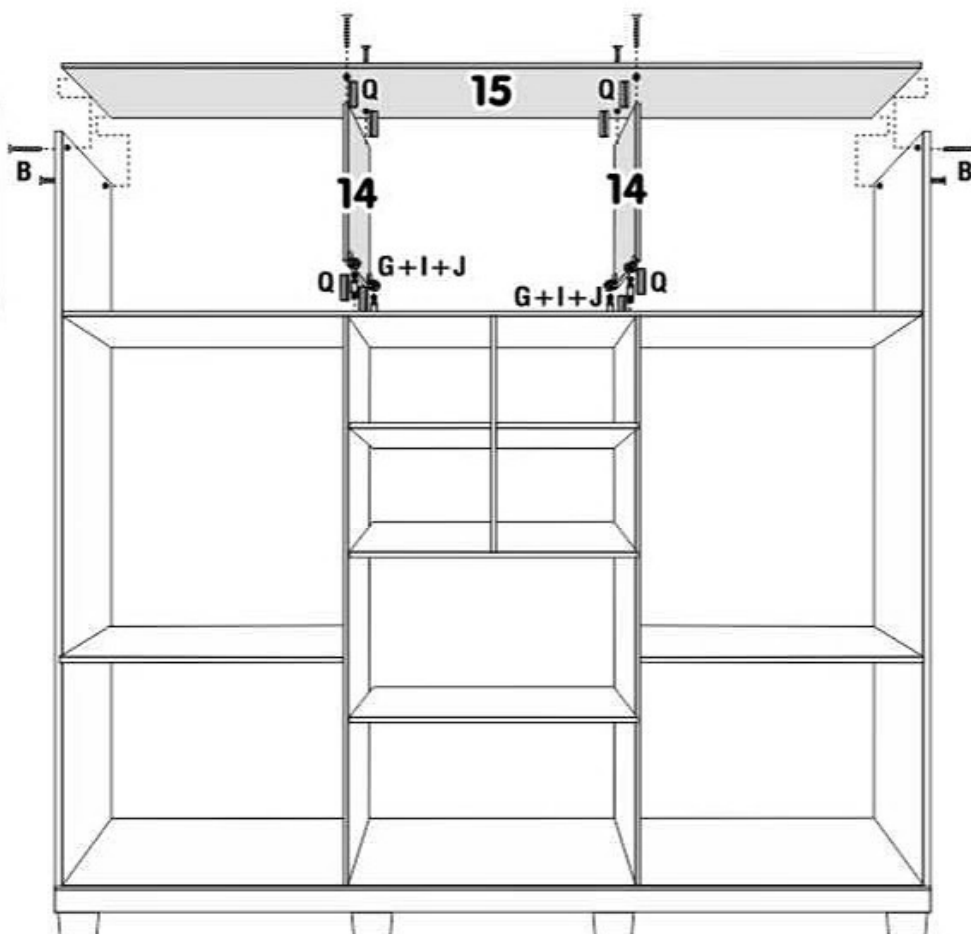
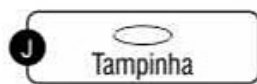
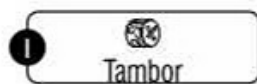
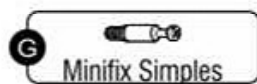
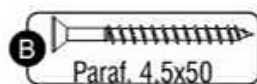

## Sequência de Montagem

- 14 - Fixar peças 16 nas peças 01, 04 e também na peça 15.  
 15 - Encaixar e fixar peças 17 nas seguintes peças 01 e 07 e nas peça 04 e 07.

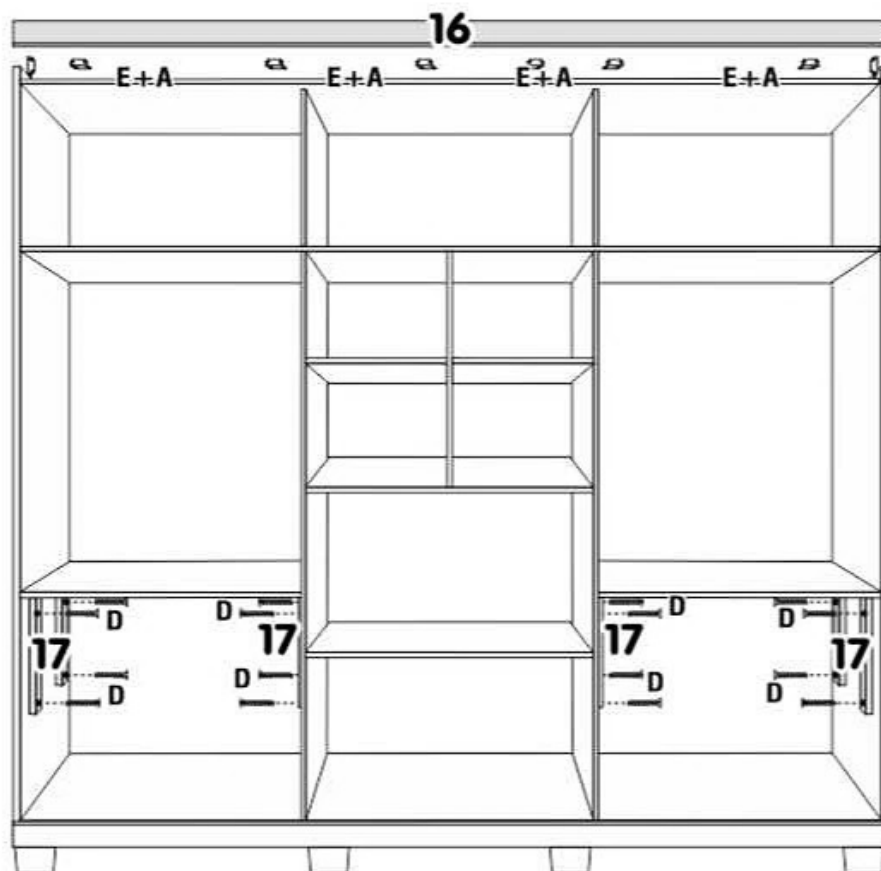
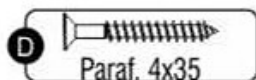
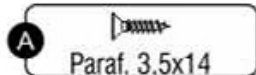

## Sequência de Montagem

- 16 - Montar os cabideiros com os suportes.  
 17 - Parafusar as corredeiras.

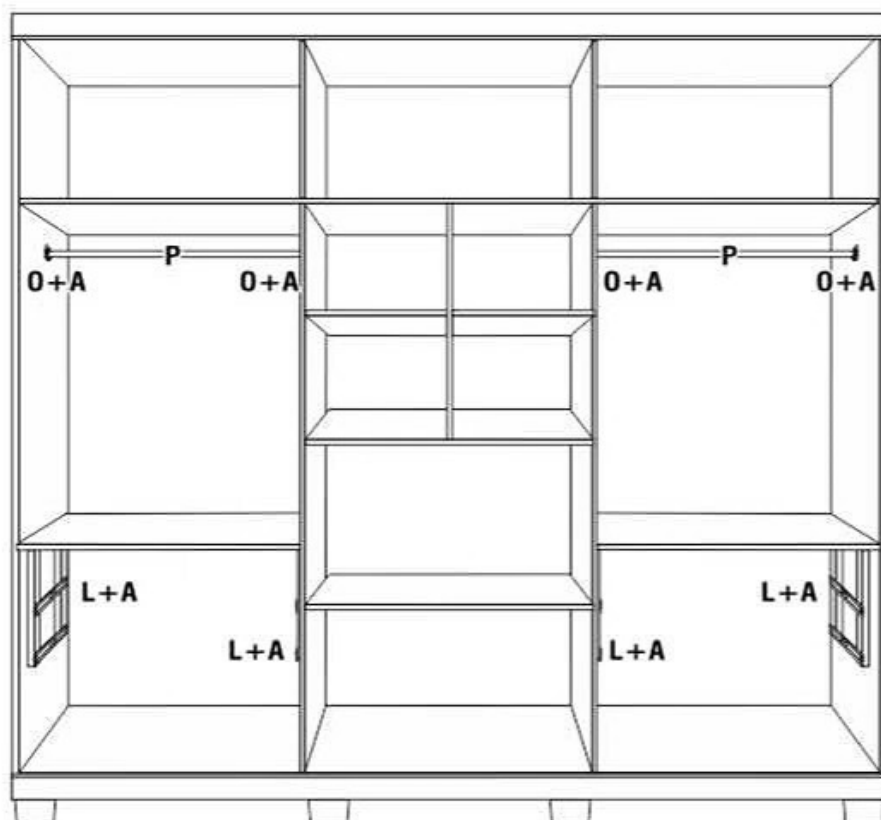
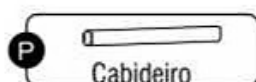

## Sequência de Montagem

18 - Preguar as Costas 22 com perfil H 23.

OBS.: Acertar as costas para melhor esquadramento do móvel.

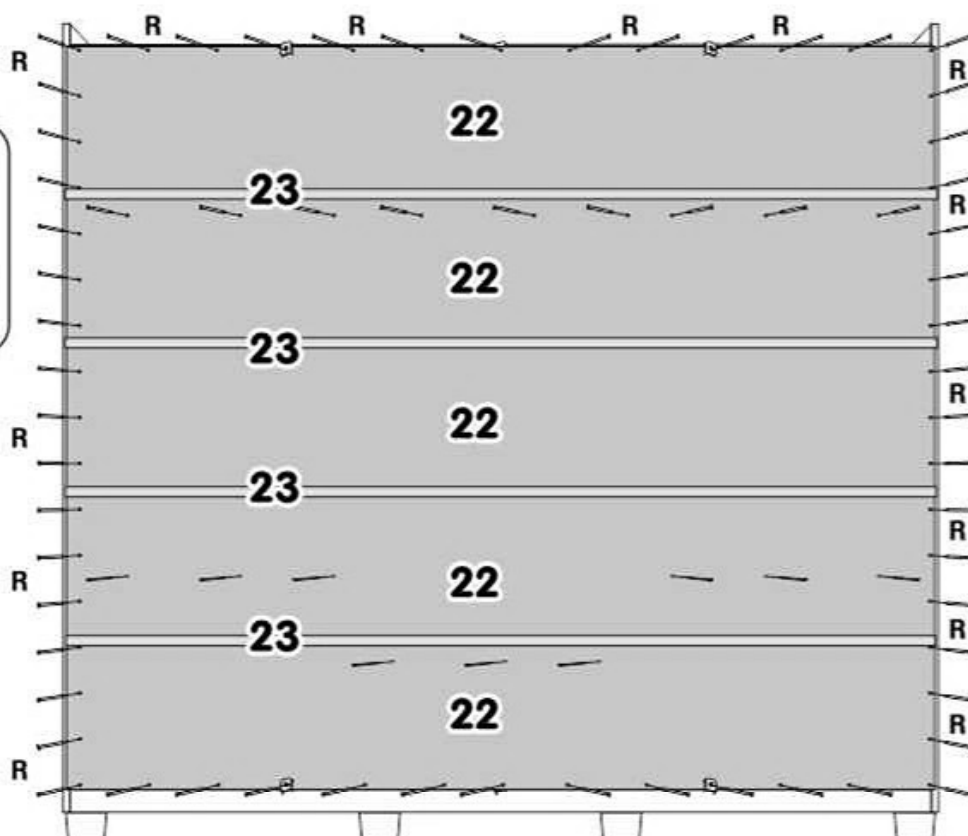
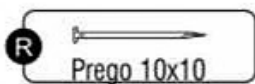
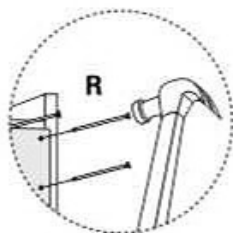

## Sequência de Montagem

19 - Montar e fixar as Portas 24.

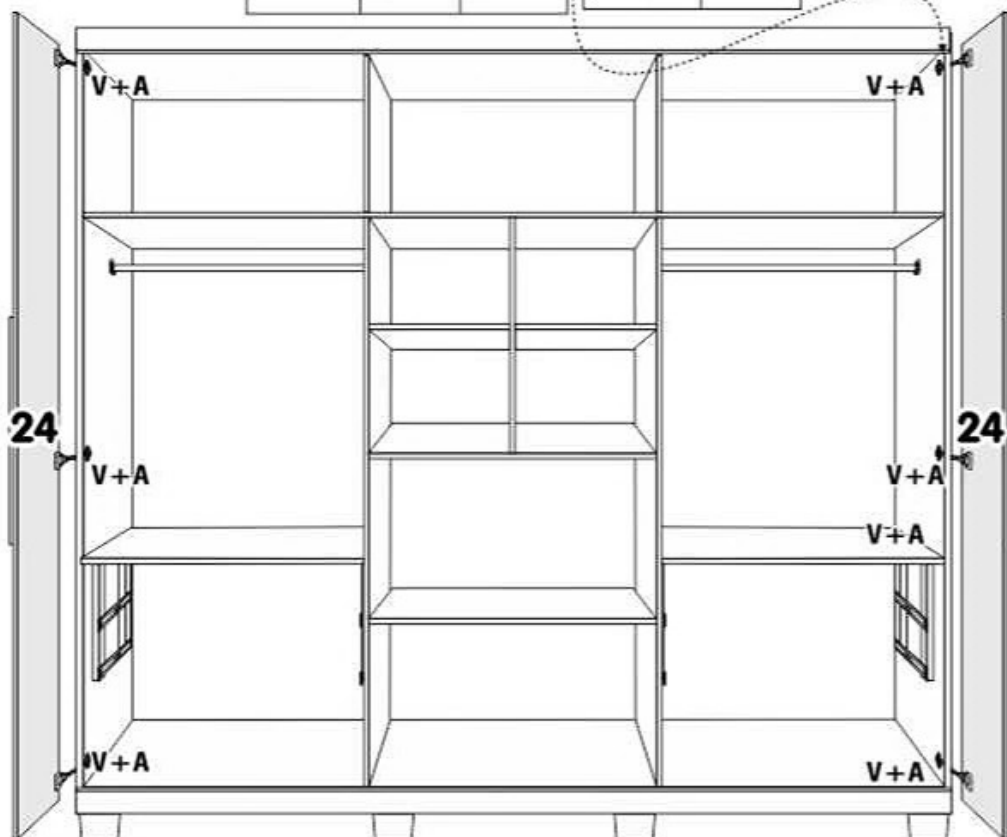
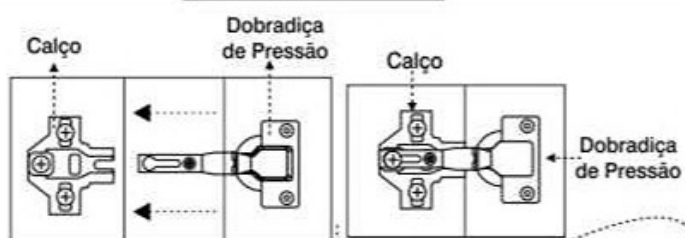
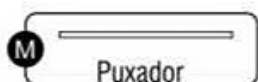
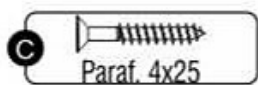
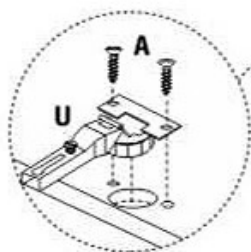

7

## Sequência de Montagem

- 20 - Parafusar as cantoneiras nas peças 19;
- 21 - Parafusar as peças 19 na peça 18 colocando cola nas cavilhas;
- 22 - Pregar a peça 20 nas peças 19;
- 23 - Parafusar peça 21 nas peças 19 e 20 conforme desenho abaixo, ajustando para melhor esquadramento da gaveta;
- 24 - Parafusar as corrediças na lateral da peça 19;

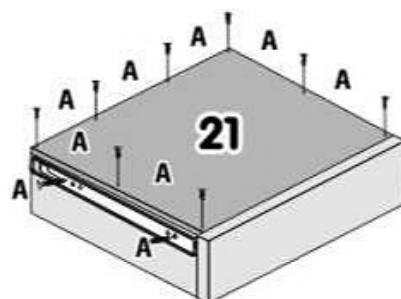
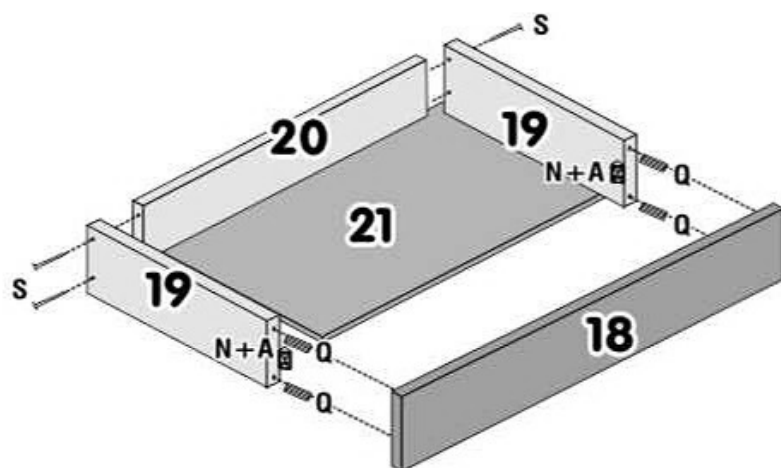
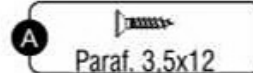

# Benetil

Móveis

Av. Jesus Candian, 395 - B. Mangueira Rural

Telefax (32) 3539-5350

CEP 36500-000 - Ubá - Minas Gerais

[www.benetil.com.br](http://www.benetil.com.br)