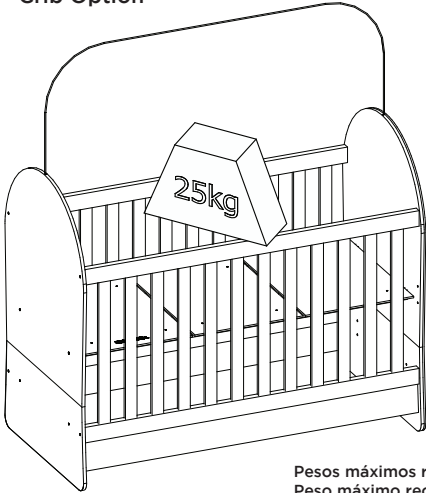

**HENN**Ind. e Com. de Móveis Henn  
Mondaiá - SC - Brasil

☎ +55 49 3674.3500

📧 @moveishenn  
www.henn.com.br**INSTRUÇÕES DE  
MONTAGEM****INSTRUCCIONES DE MONTAJE  
ASSEMBLY INSTRUCTIONS****Berço Mini Cama Magia | Mini Cuna Cama Magia | Mini Magia Bed Crib****130-190 Branco/Jequitibá HP****Opção Berço  
Opción de cuna  
Crib Option****Opção Sofá Cama  
Opción de sofá cama  
Sofa Bed Option****Opção Mini Cama  
Opción de cama pequena  
Mini Bed Option**

Pesos máximos recomendados com carga distribuída  
Peso máximo recomendado con la carga distribuida  
Recommended maximum weight with distributed load.

**AVISO**

Para limpeza de seu móvel, use uma flanela seca ou umedecida, e não utilize produtos químicos que possam danificar seu produto.

**SISTEMA DE MONTAGEM**

O sistema de montagem dos produtos, funciona de acordo com a ordem crescente dos números indicados no desenho. Ex: 01, 02, 03, 04... até a conclusão da montagem.

**ASSISTÊNCIA TÉCNICA**

Para solicitação de Assistência Técnica você consumidor deverá entrar em contato com o Lojista o qual você realizou a compra deste produto e solicitar a assistência técnica das peças avariadas. A garantia abrange todas as peças, partes e componentes que eventualmente venham apresentar defeito de fabricação no prazo de 03 (três) meses, contando a partir da entrega do produto ao consumidor, mediante nota fiscal de compra. Se houver qualquer alteração na estrutura do produto ou ocorrer defeito por negligência do montador/consumidor em relação a instrução de montagem e manuseio, não será fornecido assistência técnica gratuita.

**ADVERTENCIA**

Para limpieza de su móvil, use una flanela seca o húmeda, y no utilice productos químicos que puedan dañar su producto.

**SISTEMA DE MONTAJE**

El sistema de montaje de los productos funciona de acuerdo con el orden creciente de los números indicados en el dibujo. Ej.: 01, 02, 03, 04... hasta la conclusión del montaje.

**ASISTENCIA TÉCNICA**

Para solicitar Asistencia Técnica, el consumidor debe comunicarse con el Comercio que usted realizó la compra de este producto y solicita asistencia técnica para las partes dañadas. La garantía cubre todas las partes, piezas y componentes que eventualmente puedan presentar defecto de fabricación en el plazo de 03 (tres) meses, contados a partir de la entrega del producto al consumidor, mediante factura de compra. Si se produce algún cambio en la estructura del producto o se produce un defecto por negligencia del montador/consumidor en relación con las instrucciones de montaje y manipulación, no se prestará asistencia técnica gratuita.

**NOTICE**

To clean your furniture, use a dry or wet cloth, and do not use chemicals that may damage your product.

**ASSEMBLY SYSTEM**

The products' assembly system works according to the increasing order of the indicated numbers. For example: 01, 02, 03, 04 ... to the end of the assembly.

**TECHNICAL ASSISTANCE**

To request Technical Assistance, the consumer must contact the retailer from whom you purchased this product and request technical assistance for the damaged parts. The warranty covers all parts, parts and components that may eventually present a manufacturing defect within a period of 03 (three) months, counting from the delivery of the product to the consumer, by means of a purchase invoice. If there is any change in the structure of the product or defect occurs due to negligence of the assembler/consumer in relation to the assembly and handling instruction, free technical assistance will not be provided.

# IMPORTANTE LER COM ATENÇÃO E GUARDAR PARA EVENTUAIS CONSULTAS

I) **Advertências:** Não posicionar ou utilizar o produto perto de chama aberta e outras fontes de calor, tais como aquecedores elétricos, aquecedores a gás ou outras fontes, pois o material é inflamável.

II) Não utilize o berço se alguma parte estiver quebrada, rasgada ou faltando. Utilizar somente peças de reposição recomendadas pelo fabricante.

III) Não deixe nenhum objeto dentro ou próximo ao berço que possa servir de ponto de apoio ou ofereça risco de sufocação, engasgamento ou estrangulamento, como, por exemplo, cordas, cordões de persianas/cortina, protetores, almofadas, brinquedos, fios e cabos de aparelhos elétricos.

IV) Nunca utilizar mais de um colchão no berço.

V) Crianças pequenas não podem brincar, sem vigilância, nas proximidades de um berço.

VI) **Atenção:** quando a criança for capaz de escalar o berço, ele não pode mais ser utilizado por essa criança, pois este berço foi construído para uso por crianças com capacidade motora para sentar-se, ajoelhar-se e/ou levantar-se sozinhas, porém que ainda não sejam capazes de escalar o berço.

VII) Para berços com mais de uma função, não sujeita à regulamentação: Este produto atende à regulamentação para berços infantis, não sendo as suas demais funções sujeitas à regulamentação.

VIII) Este berço não pode ser alterado, seja em sua estrutura ou em seus adornos, pois riscos à segurança da criança podem ser gerados.

IX) O comprimento e a largura do colchão utilizado com o berço devem atender as especificações deste Manual.

I) **Orientações:** A Sociedade Brasileira de Pediatria orienta colocar o bebê para dormir de barriga para cima, pois diminui em 70% o risco de morte súbita. Recomendamos conversar com o pediatra de seu filho para maiores informações.

II) Só utilize o berço quando estiver totalmente montado conforme as orientações do Manual de Instruções e após certificar que seus sistemas de travamento estão devidamente acionados.

III) O Berço deve ser colocado sobre um piso horizontal.

IV) Para berços com altura da base ajustável: A posição mais baixa é a mais segura e a base deve ser sempre utilizada nessa posição tão logo o bebê tenha idade suficiente para sentar-se.

V) Quando existirem dispositivos de apoio destacáveis para apoiar a base do berço acima da sua posição mais baixa: Antes que o berço seja utilizado na sua posição mais baixa, devem ser removidos os dispositivos usados para apoiar a base em posições mais altas.

VI) As conexões de montagem devem ser sempre apertadas adequadamente e verificadas regularmente, ao longo do uso do berço, e reapertadas conforme necessário.

VII) Caso alguma parte do berço quebre ou apresente defeito, deve-se procurar assistência técnica especializada e não serem realizados consertos caseiros.

VIII) Orientações para a espessura do colchão, que podem ser dadas pelas seguintes formas:

a) O comprimento e a largura do colchão utilizado com o berço devem ser tais que nunca seja possível a formação de espaço maior que 30mm entre as laterais ou extremidades e o colchão.

b) A espessura do colchão deve ser tal que a altura interna (da superfície do colchão até a borda superior da armação do berço) seja de pelo menos 480mm na posição mais baixa da base do berço e pelo menos 180mm na posição mais elevada da base do berço.

c) Quando for utilizada uma marcação no berço para indicar a espessura máxima do colchão: A marcação no berço indica a espessura máxima do colchão a ser utilizado com o berço.

IX) **Recomendação sobre o tamanho do colchão a ser utilizado com o berço.**

Para o Berço Mini Cama Magia, recomenda-se o uso de colchão de 1,30 m  $\pm$  0,5 cm de comprimento, 60 cm  $\pm$  0,5 cm de largura e 12 cm  $\pm$  0,5 cm de altura, com densidade mínima de 18 kg/m<sup>3</sup>  $\pm$  2,0 kg/m<sup>3</sup> (D18).

# IMPORTANTE LEER CON ATENCIÓN Y GUARDAR PARA EVENTUALES CONSULTAS

I) **Advertencias:** No colocar o utilizar el producto cerca de llama abierta y otras fuentes de calor, tales como calentadores eléctricos, calentadores de gas u otras fuentes, ya que el material es inflamable.

II) No utilice la cuna si alguna parte está rota, rasgada o faltada. Utilice sólo piezas de repuesto recomendadas por el fabricante.

III) No deje ningún objeto dentro o cerca de la cuna que pueda servir de punto de apoyo o ofrezca riesgo de sofocación, engaño o estrangulamiento, como por ejemplo cuerdas, cordones de persianas / cortinas, protectores, cojines, juguetes, hilos y cables de aparatos eléctricos.

IV) Nunca utilizar más de un colchón en la cuna.

V) Los niños pequeños no pueden jugar, sin vigilancia, en las proximidades de una cuna.

VI) Atención: cuando el niño es capaz de escalar la cuna, ya no puede ser utilizado por ese niño, pues esta cuna fue construida para uso por niños con capacidad motora para sentarse, arrodillarse y / o levantarse pero que todavía no son capaces de escalar la cuna.

VII) Para cunas con más de una función, no sujeta a la reglamentación: Este producto atiende a la reglamentación para cunas infantiles, no siendo sus demás funciones sujetas a la reglamentación.

VIII) Esta cuna no puede ser alterada, sea en su estructura o en sus adornos, pues riesgos a la seguridad del niño pueden ser generados.

IX) La longitud y la anchura del colchón utilizado con la cuna deben cumplir las especificaciones de este manual.

I) **Orientaciones:** La Sociedad Brasileña de Pediatría orienta a colocar al bebé para dormir de barriga hacia arriba, pues disminuye en un 70% el riesgo de muerte súbita. Recomendamos conversar con el pediatra de su hijo para mayor información.

II) Sólo utilice la cuna cuando esté totalmente montado de acuerdo con las instrucciones del Manual de instrucciones y después de asegurarse de que sus sistemas de bloqueo están debidamente accionados.

III) La cuna debe colocarse sobre un piso horizontal.

IV) Para cunas con altura de base ajustable: La posición más baja es la más segura y la base debe ser siempre utilizada en esa posición tan pronto como el bebé tenga la edad suficiente para sentarse.

V) Cuando existan dispositivos de apoyo desmontables para apoyar la base de la cuna por encima de su posición más baja: Antes de que la cuna se utilice en su posición más baja, se deben quitar los dispositivos utilizados para apoyar la base en posiciones más altas.

VI) Las conexiones de montaje siempre deben ajustarse adecuadamente y verificadas regularmente, a lo largo del uso de la cuna, y reapertadas según sea necesario. VII) Si alguna parte de la cuna se rompe o presenta defecto, se debe buscar asistencia técnica especializada y no realizar reparaciones caseras.

VIII) Orientaciones para el espesor del colchón, que pueden darse de las siguientes formas:

a) La longitud y la anchura del colchón utilizado con la cuna deben ser tales que nunca sea posible la formación de espacio mayor a 30 mm entre los laterales o los extremos y el colchón.

b) El espesor del colchón debe ser tal que la altura interna (de la superficie del colchón hasta el borde superior del armazón de la cuna) sea de al menos 480 mm en la posición más baja de la base de la cuna y al menos 180 mm en la posición más elevada de la base de la cuna.

c) cuando se utilice un marcado en la cuna para indicar el espesor máximo del colchón: El marcado en la cuna indica el grosor máximo del colchón que se utilizará con la cuna.

IX) Recomendación sobre el tamaño del colchón que se utilizará con la cuna. Para la Cuna Mini Cama Magia, se recomienda el uso de un colchón de 1,30 m  $\pm$  0,5 cm longitud, 60 cm  $\pm$  0,5 cm de ancho y 12 cm  $\pm$  0,5 cm de alto, con una densidad mínima de 18 kg / m<sup>3</sup>  $\pm$  2,0 kg / m<sup>3</sup> (D18).

# WARNING READ WITH ATTENTION AND SAVE FOR EVENTUAL CONSULTATIONS

- I) **Warnings:** Do not position or use the product near open flame and other sources of heat such as electric heaters, gas heaters or other sources as the material is flammable.
- II) Do not use the crib if any part is broken, torn or missing. Use only replacement parts recommended by the manufacturer.
- III) Do not leave any object in or near the crib that may serve as a foothold or risk of suffocation, choking or strangulation, such as ropes, blinds / curtain cords, protectors, cushions, toys, wires and cables of electrical appliances.
- IV) Never use more than one mattress in the crib.
- V) Small children may not play, unattended, in the vicinity of a crib.
- VI) Caution: when the child is able to climb the crib, it can no longer be used by this child, as this crib was built for use by children with motor ability to sit, kneel and / or get up alone but not yet able to climb the crib.
- VII) For cribs with more than one function, not subject to regulation: This product complies with regulations for baby cribs, and its other functions are not subject to regulation.
- VIII) This crib can not be altered, either in its structure or in its adornments, because risks to the child's safety can be generated.
- IX) The length and width of the mattress used with the crib must comply with the specifications of this Manual.
- I) **Guidelines:** The Brazilian Society of Pediatrics advises to place the baby to sleep on his belly up, as it reduces the risk of sudden death by 70%. We recommend talking to your child's pediatrician for more information.
- II) Only use the crib when fully assembled in accordance with the instructions in the Instruction Manual and after making sure that your locking systems are properly engaged.
- III) The crib must be placed on a horizontal floor.
- IV) For cribs with adjustable base height: The lowest position is the safest and the base should always be used in this position as soon as the baby is old enough to sit.
- V) When there are detachable supporting devices to support the crib base above its lowest position: Before the crib is used in its lowest position, the devices used to support the crib in the highest positions should be removed.
- VI) The mounting connections must always be tightened properly and checked regularly, throughout the use of the crib, and retightened as necessary.
- VII) If any part of the crib breaks or is defective, you should look for expert technical assistance and no home repairs.
- VIII) Guidelines for the thickness of the mattress, which may be given in the following ways:
- a) The length and width of the mattress used with the crib shall be such that it is never possible to form a space greater than 30 mm between the sides or ends and the mattress.
- b) The thickness of the mattress shall be such that the inner height (from the mattress surface to the upper edge of the cradle frame) is at least 480 mm in the lowest position of the cradle base and at least 180 mm in the highest position of the cradle of the crib.
- c) When a marking is used on the crib to indicate the maximum thickness of the mattress: The marking on the crib indicates the maximum thickness of the mattress to be used with the crib.
- IX) Recommendation on the minimum size of mattress to be used with the crib. For the Mini Magia Bed Crib, the use of a 1,30 m  $\pm$  0.5 cm mattress is recommended length, 60 cm  $\pm$  0,5 cm wide and 12 cm  $\pm$  0,5 cm high, with a minimum density of 18 kg / m<sup>3</sup>  $\pm$  2,0 kg / m<sup>3</sup> (D18).

**O REGISTRO NO INMETRO E O  
SELO DE IDENTIFICAÇÃO DA  
CONFORMIDADE REFEREM-SE  
SOMENTE AO BERÇO**

**EL REGISTRO EN EL INMETRO Y  
EL SELLO DE IDENTIFICACIÓN  
DE LA CONFORMIDAD SE  
REFERE SOLAMENTE AL BERZO**

**THE INMETRO REGISTRATION  
AND THE CONFORMITY IDEN-  
TIFICATION SEAL REFER ONLY  
TO THE CRIB**

# ACESSÓRIOS | ACCESORIOS | ACCESSORIES

A	x12	B	x12	C	x8	D	x8	E	x6
---	-----	---	-----	---	----	---	----	---	----

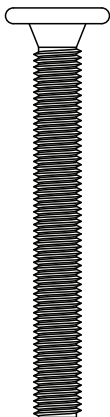

1/4x50mm



4,5x25mm

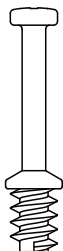

F	x4	G	x4	H	x4	I	x14	J	x2
---	----	---	----	---	----	---	-----	---	----

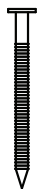
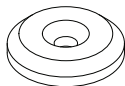
**IMPORTANTE**

Os itens (I e J) serão usados apenas na Opção Mini Cama

**IMPORTANTE**

Los artículos (I y J) solo se utilizarán en la Opción Mini Bed

**IMPORTANT**

Items (I and J) will only be used in Option Mini Bed

Parafusos em escala  
Tornillos escalados  
Scaled screws **1:1**

# LISTA DE PEÇAS | LISTA DE PIEZAS | LIST OF PIECES

Item	Caixa Caja Box	Qtd Ctd Qty	Descrição Descripción Description	Dimensões (mm)   Dimensiones (mm)   Dimensions (mm)		
				Comprimento Largo Length	Largura Ancho Width	Espessura Grosor Thickness
1	1/1	2	LATERAL INFERIOR   LATERAL INFERIOR   LATERAL SIDE	685	330	12
2	1/1	2	TRAVESSA ESTRUTURAL   TRAVESAÑO ESTRUCTURAL   STRUCTURAL FRAME	1301	110	15
3=5	1/1	1	LATERAL SUPERIOR   LATERAL SUPERIOR   UPPER LATERAL	770	685	12
4=9	1/1	1	GRADE FIXA   REJILLA FIJA   FIXED RAIL	1300	670	25
5=3	1/1	1	LATERAL SUPERIOR   LATERAL SUPERIOR   UPPER LATERAL	770	685	12
6	1/1	2	TRAVESSA PARA BERÇO   TRAVESAÑO PARA CUNA   CRIB FRAME	1301	36	22
7	1/1	1	LASTRO MAIOR 6MM COM CARIMBO E ETIQUETA   LASTRE MAYOR 6MM CON SELLO Y ETIQUETA   LARGER BALLAST 6MM WITH STAMP AND LABEL	595	420	6
8	1/1	2	LASTRO MAIOR 6MM   LASTRE MAYOR 6MM   6MM LARGEST BASE FRAME	595	420	6
9=4	1/1	1	GRADE FIXA   REJILLA FIJA   FIXED RAIL	1300	670	25
10	1/1	1	SUPORTE MOSQUITEIRO   SOPORTE DE MOSQUITERO   MOSQUITO NET SUPPORT	1320		

Opção Berço  
Opción de cuna  
Crib Option

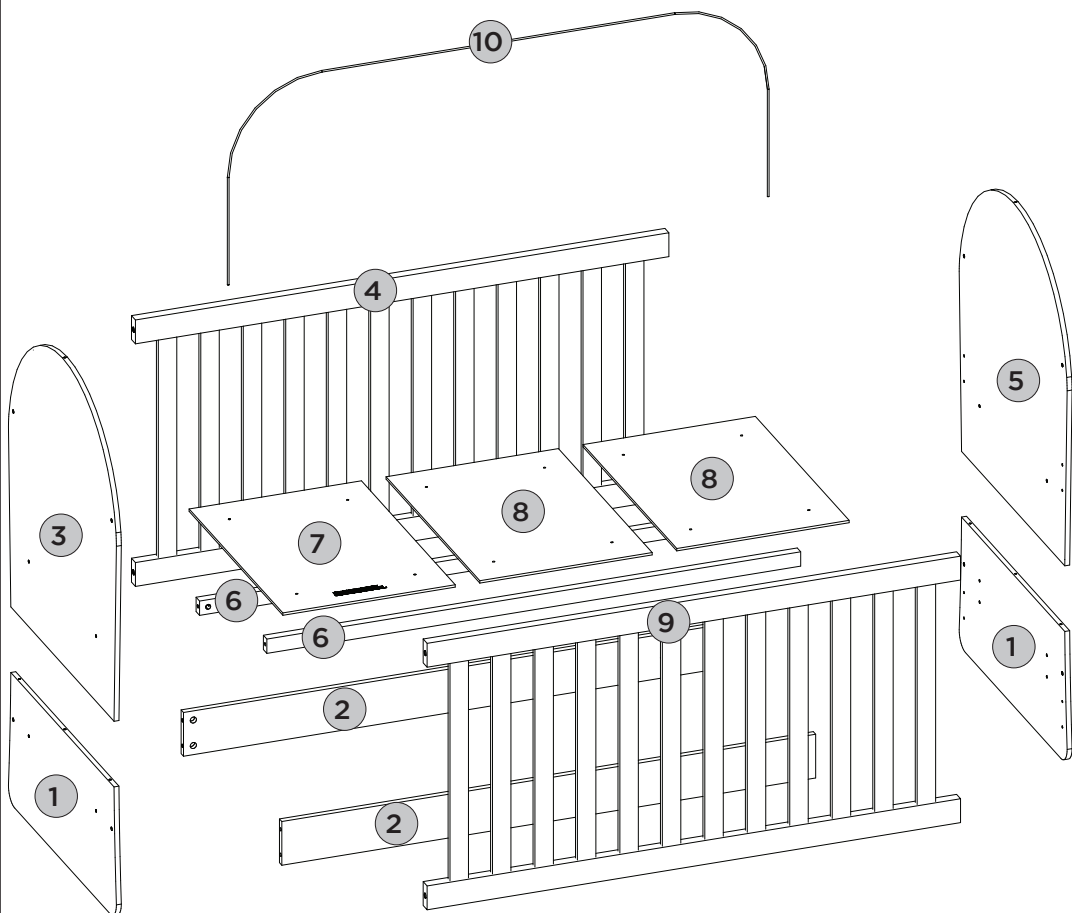

REQUISITOS PARA MONTAGEM  
REQUISITOS PARA LA MONTAJE | ASSEMBLY REQUIREMENTS.

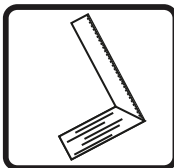
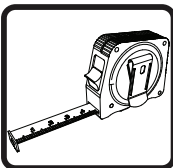
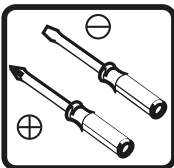
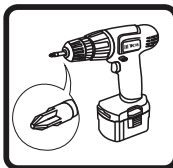





Imagens meramente ilustrativas, não acompanha o produto.  
Imágenes ilustrativas, no incluidas con el producto.  
Illustrative images, not included with the product.

**PEÇAS REQUERIDAS**

1	LATERAL INFERIOR	x2
6	TRAVESSA PARA BERÇO	x2

**ACESSÓRIOS REQUERIDOS**

C		08
E		06
F		04
G		04
H		02

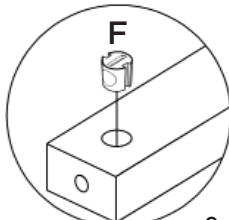
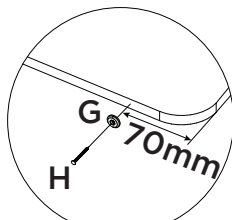
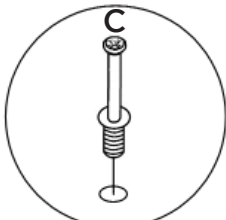
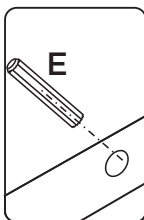
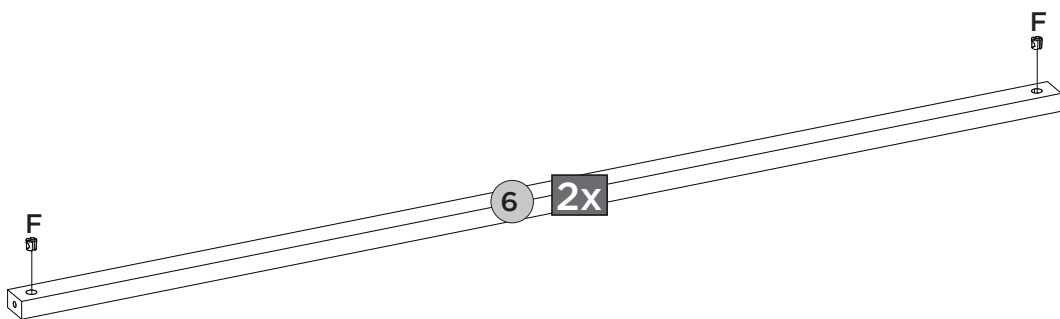
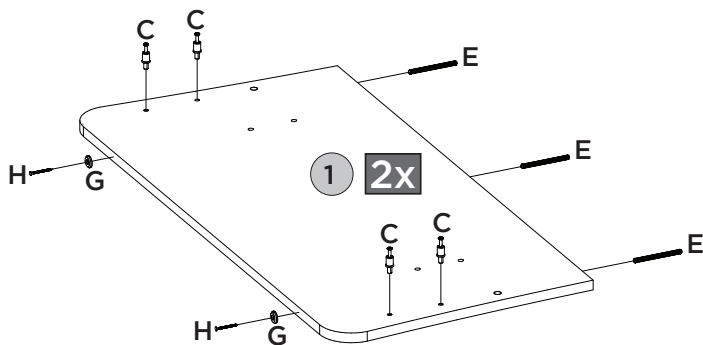
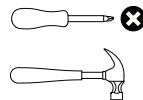
**FERRAMENTAS NECESSÁRIAS**

**PEÇAS REQUERIDAS**

1	LATERAL INFERIOR	x2
2	TRAVESSA ESTRUTURAL	x2

**ACESSÓRIOS REQUERIDOS**

D		08
---	--	----

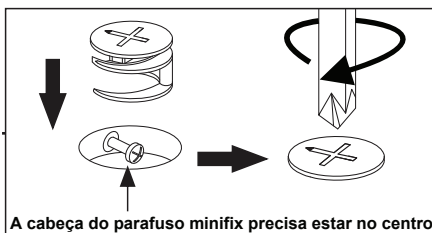
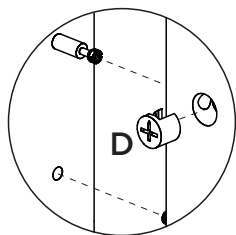
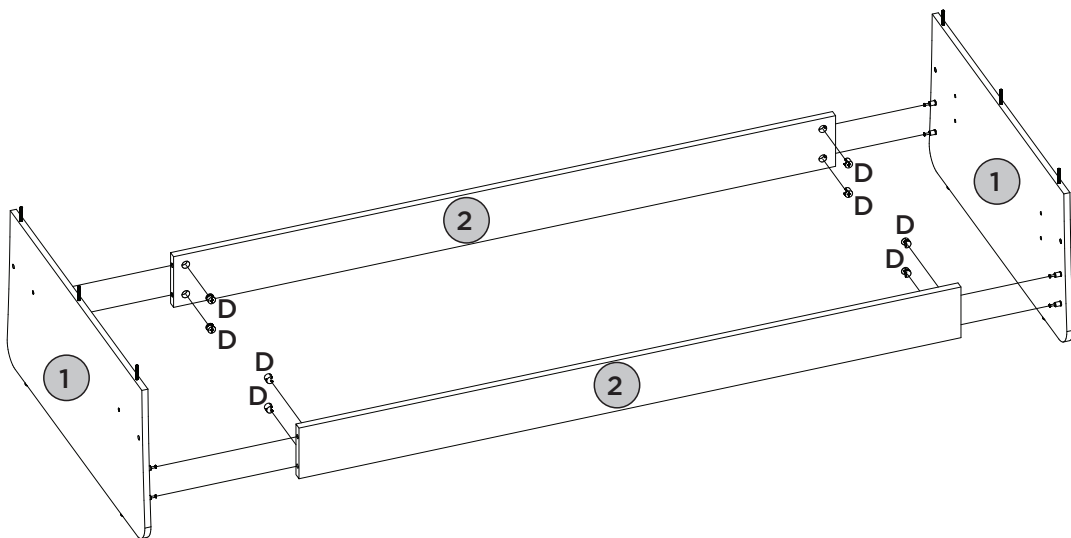
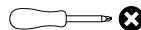
**FERRAMENTAS NECESSÁRIAS**

**PEÇAS REQUERIDAS**

3=5	LATERAL SUPERIOR	x2
4	GRADE FIXA	x1

**ACESSÓRIOS REQUERIDOS**

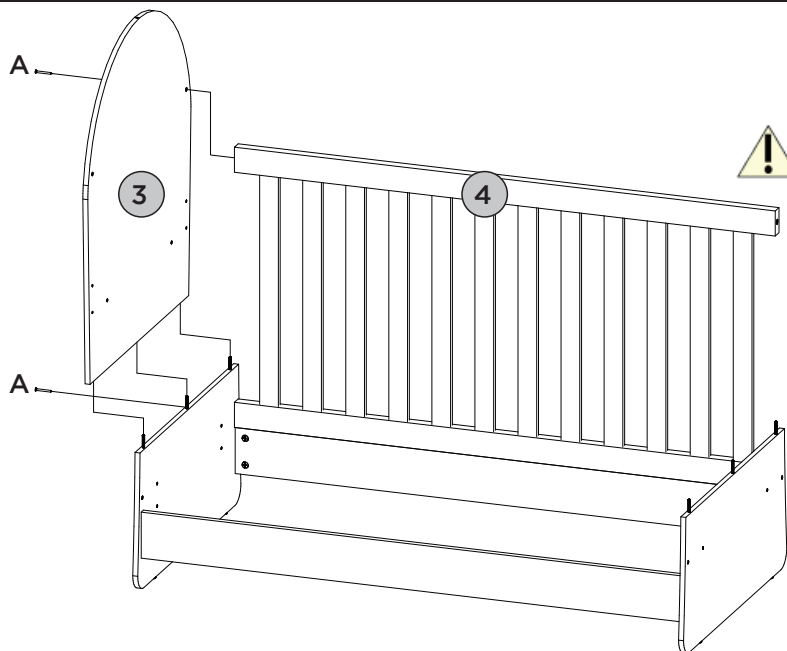
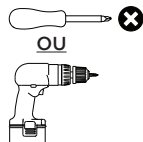
**FERRAMENTAS NECESSÁRIAS**

Utilizar a parafusadeira com o torque em 15 para fixar a grade e para fixar o lastro.

Utilizar la atornilladora con el torque en 15 para fijar la rejilla y para fijar el lastro.

Use the screwdriver with the torque at 15 to attach the rail and base frame.

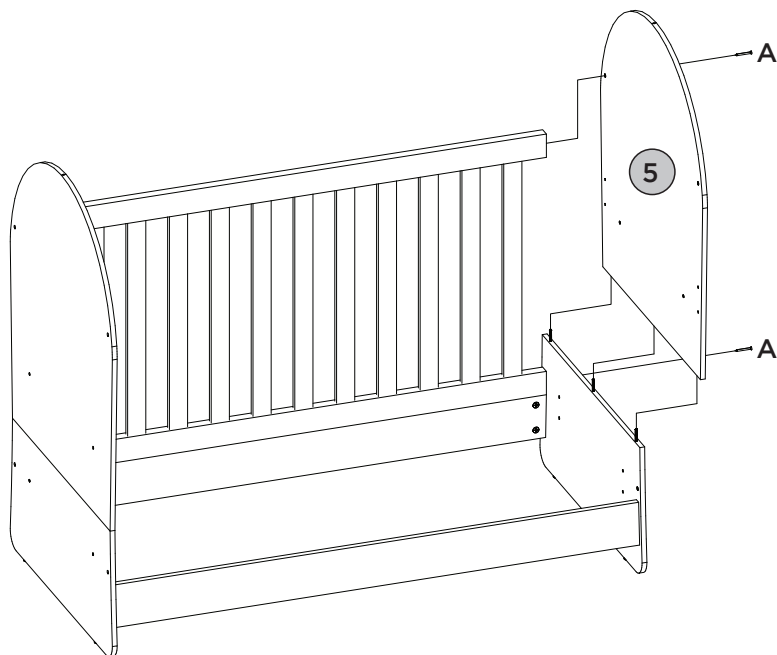

**PEÇAS REQUERIDAS**

6	TRAVESSA PARA BERÇO	x2
---	---------------------	----

**ACESSÓRIOS REQUERIDOS**

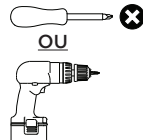
**FERRAMENTAS NECESSÁRIAS**

Opções para montar o  
Lastro

Opciones para montar el  
balasto

Options for mounting the  
Ballast



Opção mais alta do  
lastro

Opción de lastre  
superior

Higher Ballast  
Option

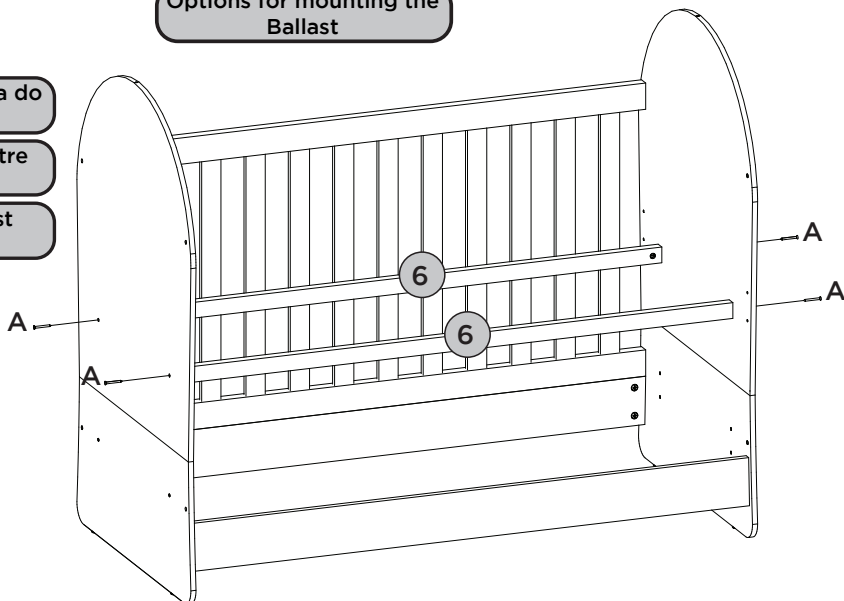

Opção mais baixa  
do lastro

Opción de lastre  
inferior

Lower Ballast  
Option

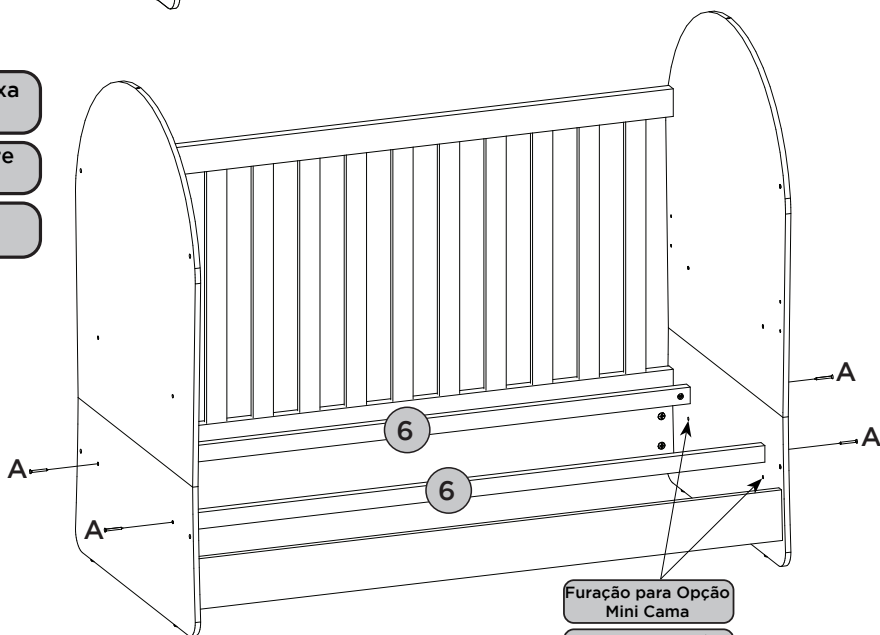

Furação para Opção  
Mini Cama

Mini cama Opción  
de perforación

Mini Bed Option  
Drilling

**PEÇAS REQUERIDAS**

7	LASTRO MAIOR 6MM COM CARIMBO E ETIQUETA	x1
8	LASTRO MAIOR 6MM	x2

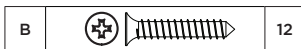
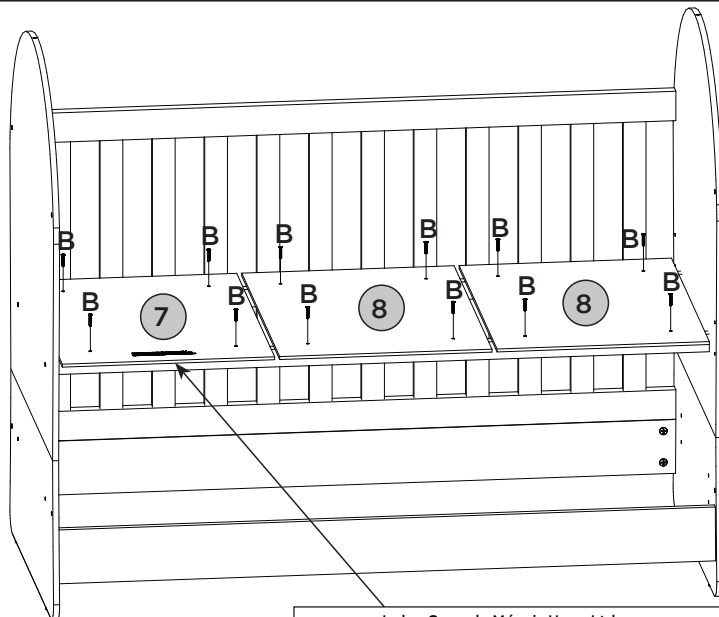
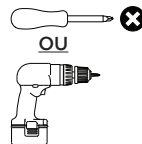
**ACESSÓRIOS REQUERIDOS**

**FERRAMENTAS NECESSÁRIAS**

Utilizar a parafusadeira com o torque em 15 para fixar a grade e para fixar o lastro.

Utilizar la atornilladora con el torque en 15 para fijar la rejilla y para fijar el lastre.

Use the screwdriver with the torque at 15 to attach the rail and base frame.



Os lastros da base não podem ser removidos da travessa estrutural para fins de transporte, armazenamento e/ou alteração de função.

Los lastres de base no se pueden quitar de la viga estructural para su transporte, almacenamiento y/o cambio de función.

Base ballasts cannot be removed from the structural beam for transportation, storage and/or change of function.

Ind. e Com. de Móveis Henn Ltda.  
 CNPJ 85.355.592/0001-17  
 Berço Mini Cama Magia

Norma ABNT NBR 15860-1: 2016;  
 Recomenda-se o uso de colchões com espessura máxima permitida de 120mm conforme ABNT NBR 13579-1.

PEDIDO: (numero) LOTE: (numero) DATA: (dia/mês/ano)

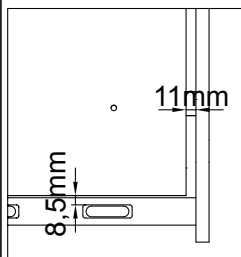

Para a opção mais alta a distância entre os lastros da extremidade com as laterais deverá ser de 11mm.

Para la opción más alta la distancia entre los lastres extremos con los laterales deberá ser de 11mm.

For the higher option the distance between the end base frame to the sides should be 11mm.

As extremidades dos lastros (07) e (08) devem ficar 8,5mm da grade fixa (04).

Lastres extremos (07) y (08) deben quedar 8,5mm de la rejilla fija (04).

The end base frames (07) and (08) must be 8,5mm from the fixed rail (04).

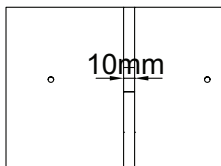

A distância entre os lastros deve ser 10mm.

La distancia entre los lastres debe ser 10mm.

The distance between ballast should be 10mm.

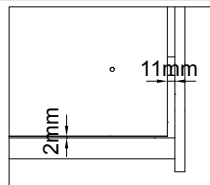

Para a opção mais baixa a distância entre os lastros da extremidade com as laterais deverá ser de 11mm.

Para la opción más baja la distancia entre los lastres extremos con los laterales deberá ser de 11mm.

For the lower option the distance between the end base frame to the sides should be 11mm.

As extremidades dos lastros (07) e (08) devem ficar 2mm da grade fixa (04).

Lastres extremos (07) y (08) deben quedar 2mm de la rejilla fija (04).

The end base frames (07) and (08) must be 2mm from the fixed rail (04).

**PEÇAS REQUERIDAS**

9=4	GRADE FIXA	x1
10	SUPORTE MOSQUITEIRO	x1

**ACESSÓRIOS REQUERIDOS**

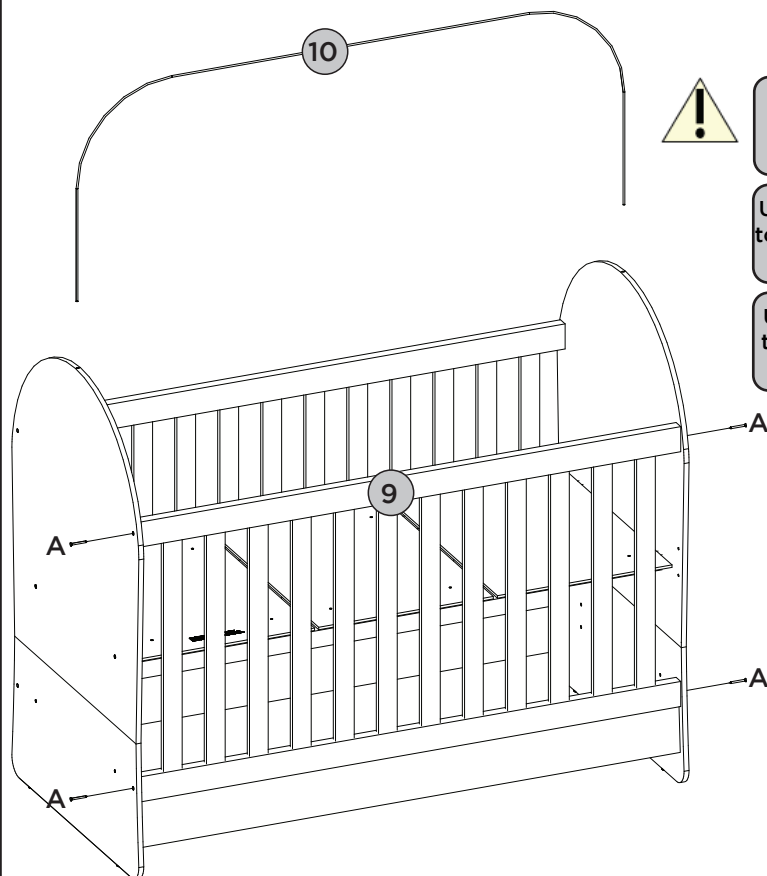
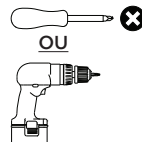
**FERRAMENTAS NECESSÁRIAS**

Utilizar a parafusadeira com o torque em 15 para fixar a grade e para fixar o lastro.

Utilizar la atornilladora con el torque en 15 para fijar la rejilla y para fijar el lastre.

Use the screwdriver with the torque at 15 to attach the rail and base frame.

Para o Berço Mini Cama Magia, os lastros da base não podem ser removidos da travessa estrutural para fins de transporte, armazenamento e/ou alteração de função.

Para la cuna Mini Magia Bed, los pesos de la base no se pueden removidos de la viga estructural para fines de transporte, almacenamiento y/o cambio de función.

For the Mini Cama Magia Crib, the base weights cannot be removed from the structural crossbar for transportation, storage and/or function change purposes.

**PRODUTO CONCLUÍDO**  
**PRODUCTO TERMINADO**  
**FINISHED PRODUCT**

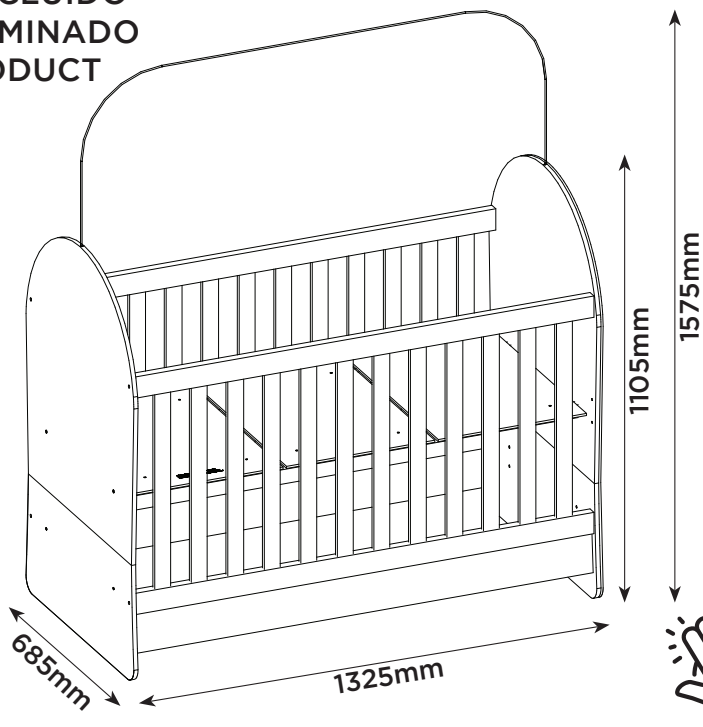

Para a montagem do sofá cama, tirar as peças marcadas com "X" e o restante das peças deverão ser utilizadas.

Para montar el sofá cama se retiran las piezas marcadas con "X" y se deben utilizar el resto de piezas.

To assemble the sofa bed, remove the parts marked with an "X" and use the remaining parts.

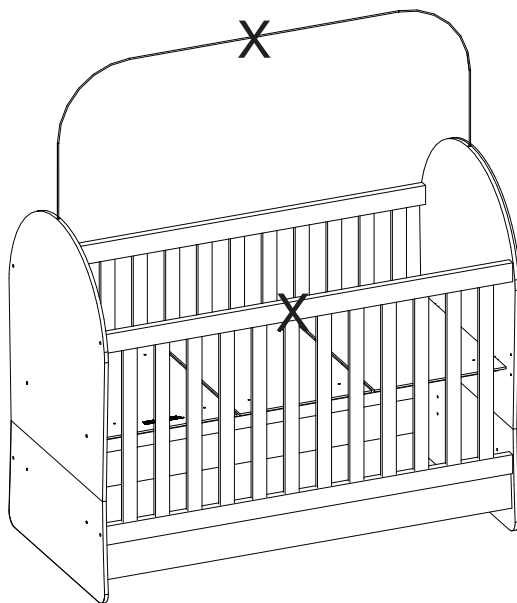

**PEÇAS REQUERIDAS**

1	LATERAL INFERIOR	x2
2	TRAVESSA ESTRUTURAL	x2
3=5	LATERAL SUPERIOR	x2
4	GRADE FIXA	x1
6	TRAVESSA PARA BERÇO	x2
7	LASTRO MAIOR 6MM COM CARIMBO E ETIQUETA	x1
8	LASTRO MAIOR 6MM	x2

**ACESSÓRIOS REQUERIDOS**

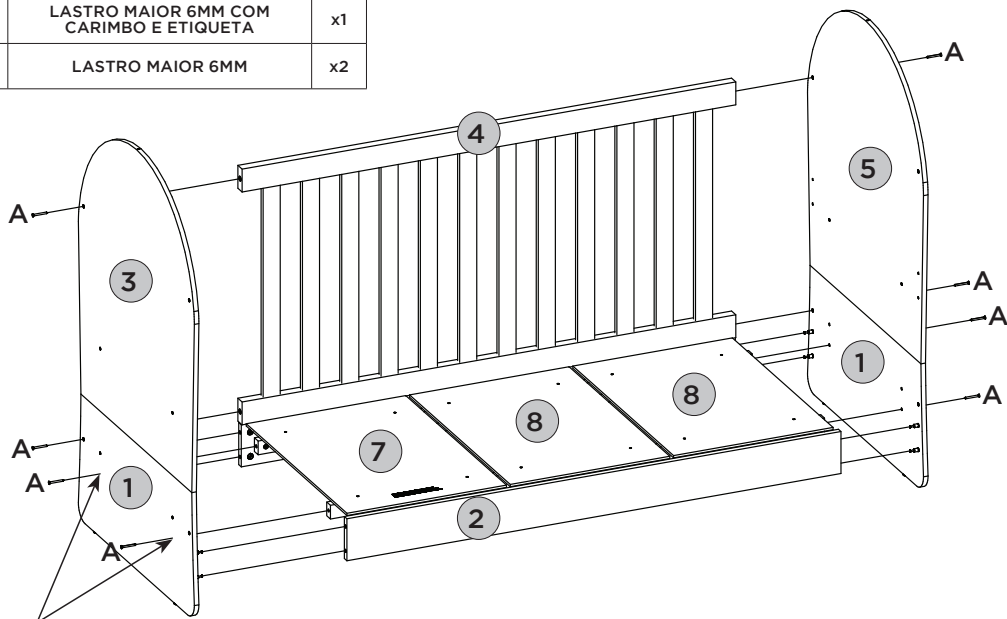
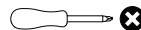
**FERRAMENTAS NECESSÁRIAS**

Fazer a furação passante para colocação do parafuso A.

Taladre agujeros para colocar el tornillo A.

Drill the through hole to place screw A.

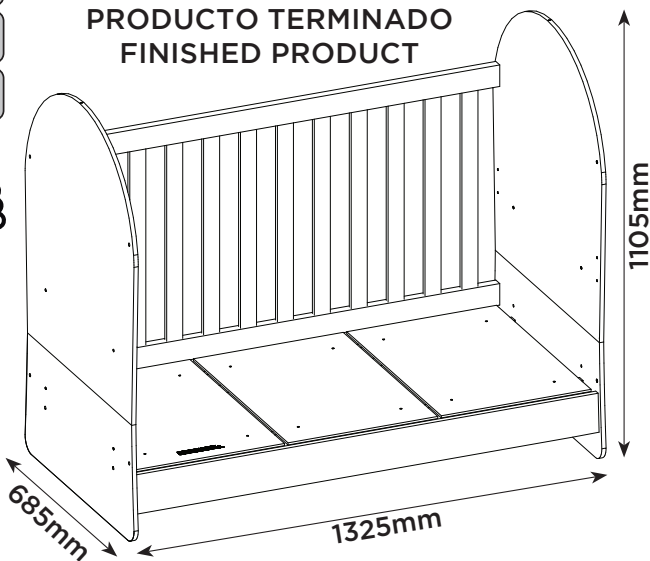
**PRODUTO CONCLUÍDO  
PRODUCTO TERMINADO  
FINISHED PRODUCT**

Para a montagem da mini cama, tirar as peças marcadas com "X" e o restante das peças deverão ser utilizadas para a montagem da mini cama.

Para el montaje de la mini cama, sacar las piezas marcadas con "X" y el resto de las piezas deberán ser utilizadas para el montaje de la mini cama.

To assemble the mini bed, remove the parts marked with "X" and the remaining parts should be used to assemble the mini bed.

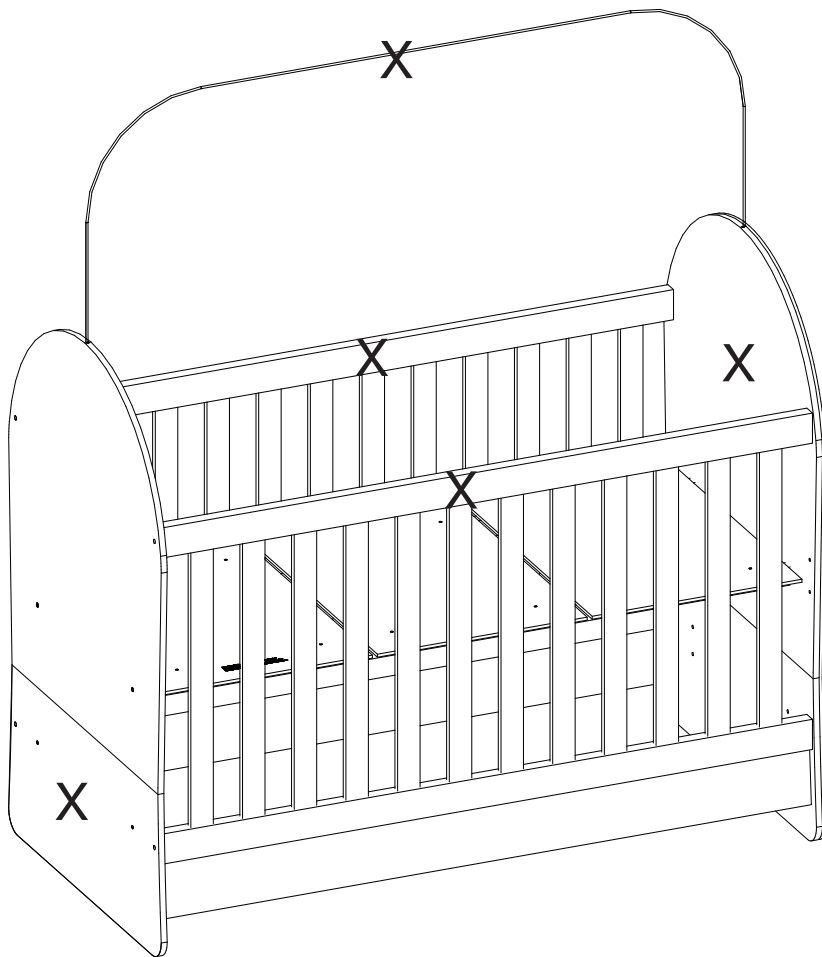

**Advertência:** Após montada o Mini Cama não se pode montar mais na versão Berço.

**Advertencia:** Una vez montada la Mini Cama, ya no se podrá montar en la versión Cuna.

**Warning:** Once the Mini Bed has been assembled, it can no longer be assembled in the Cradle version.

Opção Mini Cama  
Opción de cama pequeña  
Mini Bed Option

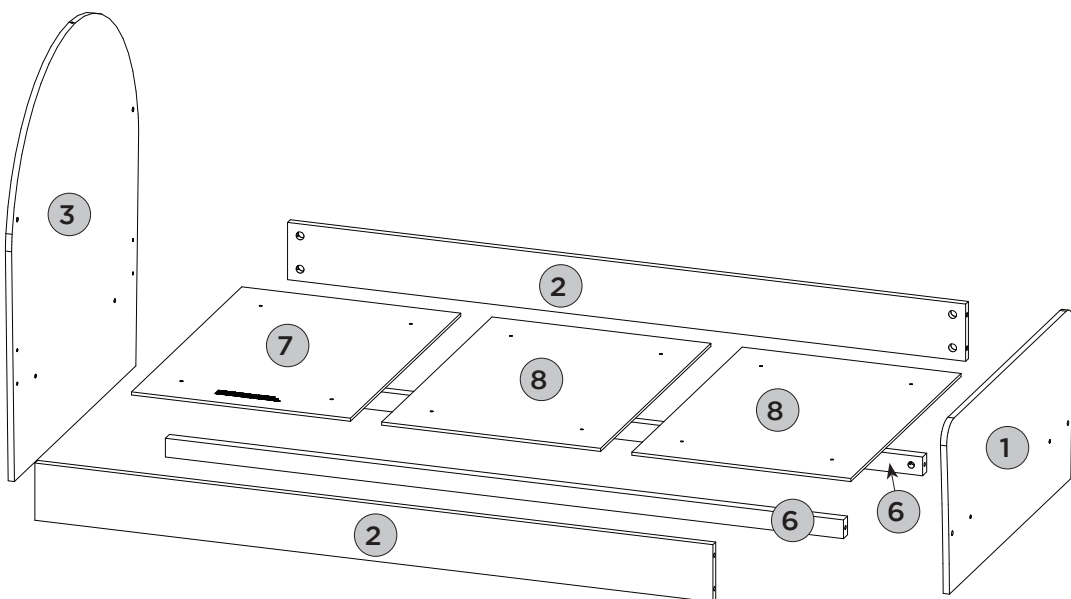

REQUISITOS PARA MONTAGEM

REQUISITOS PARA LA MONTAJE | ASSEMBLY REQUIREMENTS.

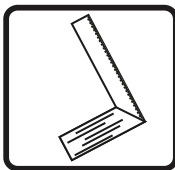
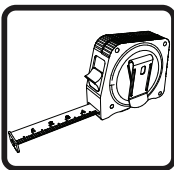
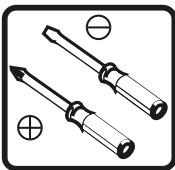
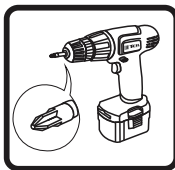

Imagens meramente ilustrativas, não acompanha o produto.



Imágenes ilustrativas, no incluidas con el producto.

Illustrative images, not included with the product.

**PEÇAS REQUERIDAS**

1	LATERAL INFERIOR	x2
2	TRAVESSA ESTRUTURAL	x2
3	LATERAL SUPERIOR	x1

**ACESSÓRIOS REQUERIDOS**



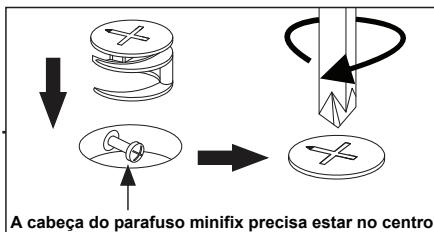
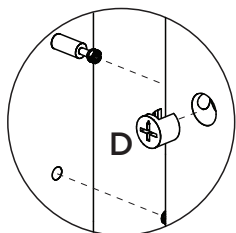
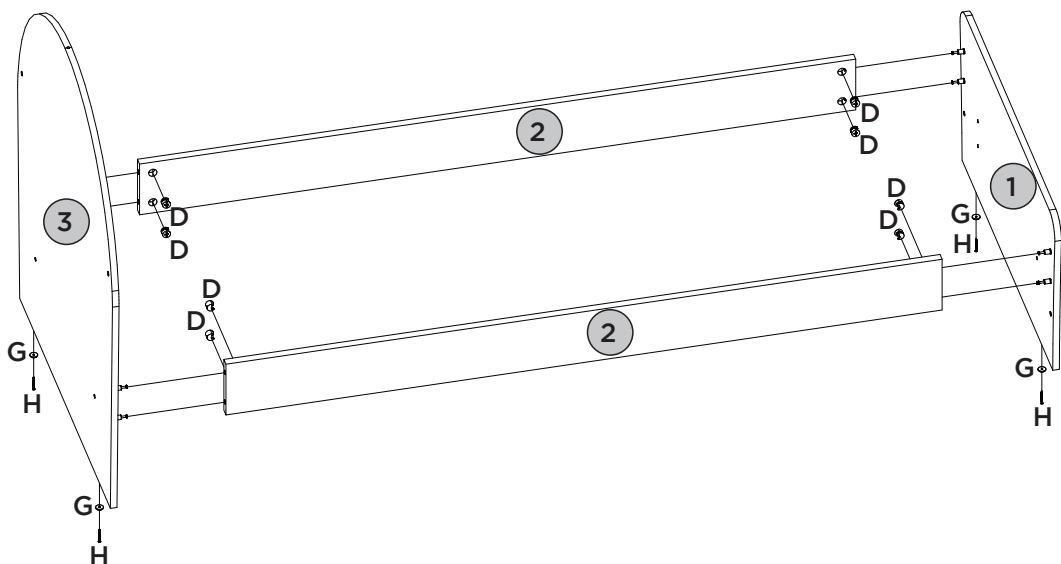
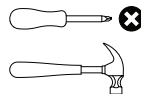

D		08
G		04
H		04

**FERRAMENTAS NECESSÁRIAS**

## PEÇAS REQUERIDAS

1	LATERAL INFERIOR	x1
---	------------------	----

## ACESSÓRIOS REQUERIDOS

A		04
B		04
I		14
J		02

## FERRAMENTAS NECESSÁRIAS

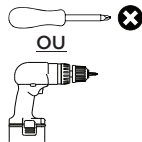

Utilizar a parafusadeira com o torque em 15 para fixar o lastro.

Utilice el destornillador con un par de 15 para fijar el lastre.

Use the screwdriver with torque at 15 to fix the ballast.

Fazer a furação passante para colocação do parafuso A.

Taladre agujeros para colocar el tornillo A.

Drill the through hole to place screw A.

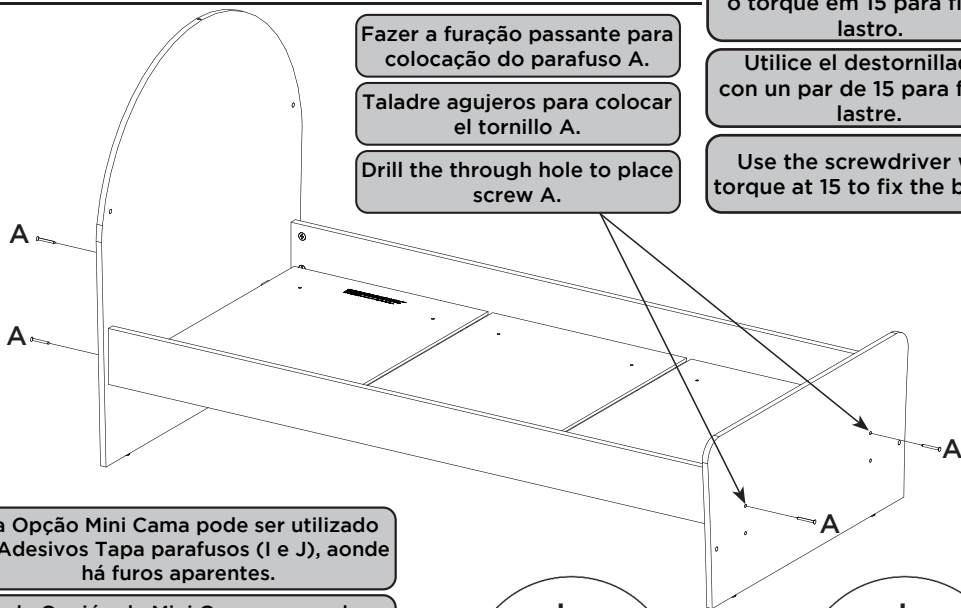

Na Opção Mini Cama pode ser utilizado os Adesivos Tapa parafusos (I e J), aonde há furos aparentes.

En la Opción de Mini Cama, se pueden usar los Adhesivos para Cubiertas de Tornillos (I y J), donde hay agujeros aparentes.

In the Mini Bed Option, the Screw Cover Adhesives (I and J) can be used, where there are apparent holes.

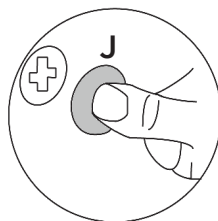
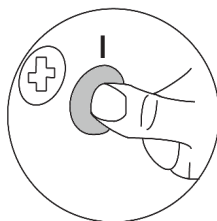

**PRODUTO CONCLUÍDO**  
**PRODUCTO TERMINADO**  
**FINISHED PRODUCT**

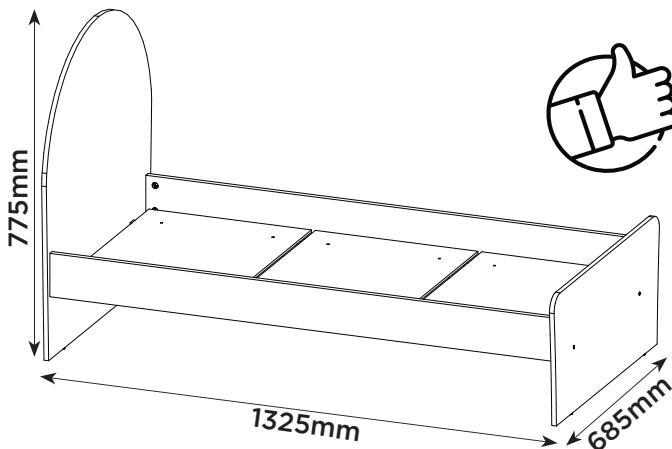

**HENN**Ind. e Com. de Móveis Henn  
Mondai - SC - Brasil

☎ +55 49 3674.3500

📱 @moveishenn  
www.henn.com.br**INSTRUÇÕES DE  
MONTAGEM****INSTRUCCIONES DE MONTAJE  
ASSEMBLY INSTRUCTIONS****ROUPEIRO MAGIA 03 PORTAS 02 GAVETAS |****ARMARIO MAGIA 03 PUERTAS 02 CAJONES | MAGIA WARDROBE 03 DOORS 02 DRAWERS**

I131-190 Branco/Jequitibá HP

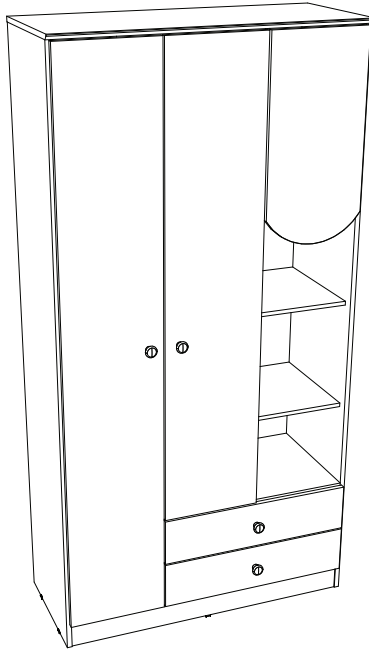
**AVISO**

Para limpeza de seu móvel, use uma flanela seca ou umedecida, e não utilize produtos químicos que possam danificar seu produto.

**SISTEMA DE MONTAGEM**

O sistema de montagem dos produtos, funciona de acordo com a ordem crescente dos números indicados no desenho. Ex: 01, 02, 03, 04... até a conclusão da montagem.

**ASSISTÊNCIA TÉCNICA**

Para solicitação de Assistência Técnica você consumidor deverá entrar em contato com o Lojista o qual você realizou a compra deste produto e solicitar a assistência técnica das peças avariadas. A garantia abrange todas as peças, partes e componentes que eventualmente venham apresentar defeito de fabricação no prazo de 03 (três) meses, contando a partir da entrega do produto ao consumidor, mediante nota fiscal de compra. Se houver qualquer alteração na estrutura do produto ou ocorrer defeito por negligência do montador/consumidor em relação a instrução de montagem e manuseio, não será fornecido assistência técnica gratuita.

**ADVERTENCIA**

Para limpieza de su móvil, use una flanela seca o húmeda, y no utilice productos químicos que puedan dañar su producto.

**SISTEMA DE MONTAJE**

El sistema de montaje de los productos funciona de acuerdo con el orden creciente de los números indicados en el dibujo. Ej.: 01, 02, 03, 04... hasta la conclusión del montaje.

**ASISTENCIA TÉCNICA**

Para solicitar Asistencia Técnica, el consumidor debe comunicarse con el Comercio que usted realizó la compra de este producto y solicita asistencia técnica para las partes dañadas. La garantía cubre todas las partes, piezas y componentes que eventualmente puedan presentar defecto de fabricación en el plazo de 03 (tres) meses, contados a partir de la entrega del producto al consumidor, mediante factura de compra. Si se produce algún cambio en la estructura del producto o se produce un defecto por negligencia del montador/consumidor en relación con las instrucciones de montaje y manipulación, no se prestará asistencia técnica gratuita.

**NOTICE**

To clean your furniture, use a dry or wet cloth, and do not use chemicals that may damage your product.

**ASSEMBLY SYSTEM**

The products' assembly system works according to the increasing order of the indicated numbers. For example: 01, 02, 03, 04 ... to the end of the assembly.

**TECHNICAL ASSISTANCE**

To request Technical Assistance, the consumer must contact the retailer from whom you purchased this product and request technical assistance for the damaged parts. The warranty covers all parts, parts and components that may eventually present a manufacturing defect within a period of 03 (three) months, counting from the delivery of the product to the consumer, by means of a purchase invoice. If there is any change in the structure of the product or defect occurs due to negligence of the assembler/consumer in relation to the assembly and handling instruction, free technical assistance will not be provided.

# ACESSÓRIOS | ACCESORIOS | ACCESSORIES

A	x1	B	x23	C	x4	D	x74	E	x4
---	----	---	-----	---	----	---	-----	---	----

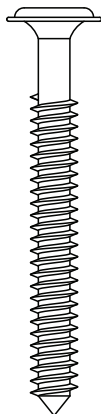

5,0x50mm



3,5x40mm



3,5x25mm



3,5x12mm



3,0x16mm

F	x58	G	x10	H	x85	I	x15	J	x6
---	-----	---	-----	---	-----	---	-----	---	----

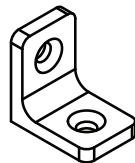
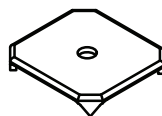
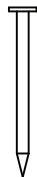
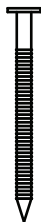
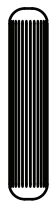

K	x1	L	x4	M	x2	N	x4	O	x6
---	----	---	----	---	----	---	----	---	----

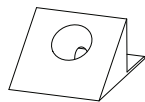
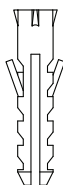

PAR

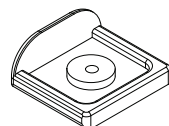

# ACESSÓRIOS | ACCESORIOS | ACCESSORIES

P	x1	Q	x2	R	x1	S	x8	T	x8
---	----	---	----	---	----	---	----	---	----

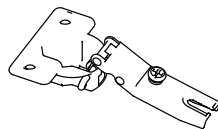
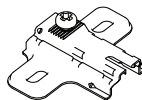
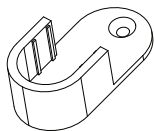
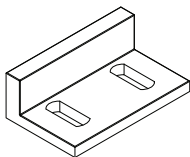

U	x1	V	x1	W	x20	X	x3	Y	x1
---	----	---	----	---	-----	---	----	---	----

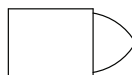

**HENN**

Z	x1
---	----

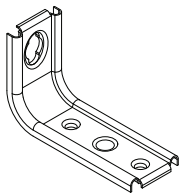

# LISTA DE PEÇAS | LISTA DE PIEZAS | LIST OF PIECES

Item	Caixa Caja Box	Qty Ctd Qty	Descrição Descripción Description	Dimensões (mm)   Dimensiones (mm)   Dimensions (mm)		
				Comprimento Largo Length	Largura Ancho Width	Espessura Grosor Thickness
1	1/1	1	RODAPÉ FRONTAL   FALDÓN DELANTERO   FRONT SKIRTING	885	73	12
2	1/1	1	RODAPÉ TRASEIRO   PIE TRASERO   REAR SKIRTING BOARD	885	73	12
3	1/1	1	LATERAL ESQUERDA   LADO IZQUIERDO   LEFT SIDE	1785	380	15
4	1/1	1	BASE   BASE   BASE	299	380	15
5	1/1	1	DIVISÃO MENOR   DIVISIÓN MENOR   MINOR DIVISION	380	281	12
6	1/1	1	TAMPO DAS GAVETAS   TAPA DE LOS CAJONES   TOP OF DRAWERS	885	380	12
7	1/1	1	PRATELEIRA INFERIOR   ESTANTE INFERIOR   LOWER SHELF	584	350	12
8	1/1	1	PRATELEIRA MAIOR   ESTANTE INFERIOR   LOWER SHELF	584	350	12
9	1/1	1	DIVISÃO   DIVISIÓN   DIVISION	1404	380	12
10	1/1	3	PRATELEIRA EXTERNA   ESTANTE EXTERNO   EXTERNAL SHELF	350	289	12
11	1/1	1	LATERAL DIREITA   LADO DERECHO   RIGHT SIDE	1785	380	15
12	1/1	1	TAMPO   TAPA   TOP	917	406	15
13	1/1	1	FUNDO EXTERNO   FONDO EXTERNO   EXTERNAL BOTTOM	1732	301	3
14	1/1	2	FUNDO   FONDO   BOTTOM	1732	301	3
15	1/1	1	PORTA   PUERTA   DOOR	1703	295	15
16	1/1	1	PORTA MENOR   PUERTA MÁS PEQUEÑA   SMALLER DOOR	1404	295	15
17	1/1	1	PORTA USINADA   PUERTA MECANIZADA   MACHINED DOOR	600	295	15
18	1/1	2	FRENTE DE GAVETA   FRENTE DEL CAJÓN   DRAWER FRONT	596	145	15
19	1/1	4	LADO DE GAVETA   LATERAL DEL CAJÓN   DRAWER SIDE	350	110	12
20	1/1	2	FUNDO DE GAVETA   FONDO DEL CAJÓN   DRAWER BOTTOM	548	361	3
21	1/1	2	RIPA DE TRÁS   TRAVESAÑO TRASERO   REAR CLAPBOARD	561	110	12

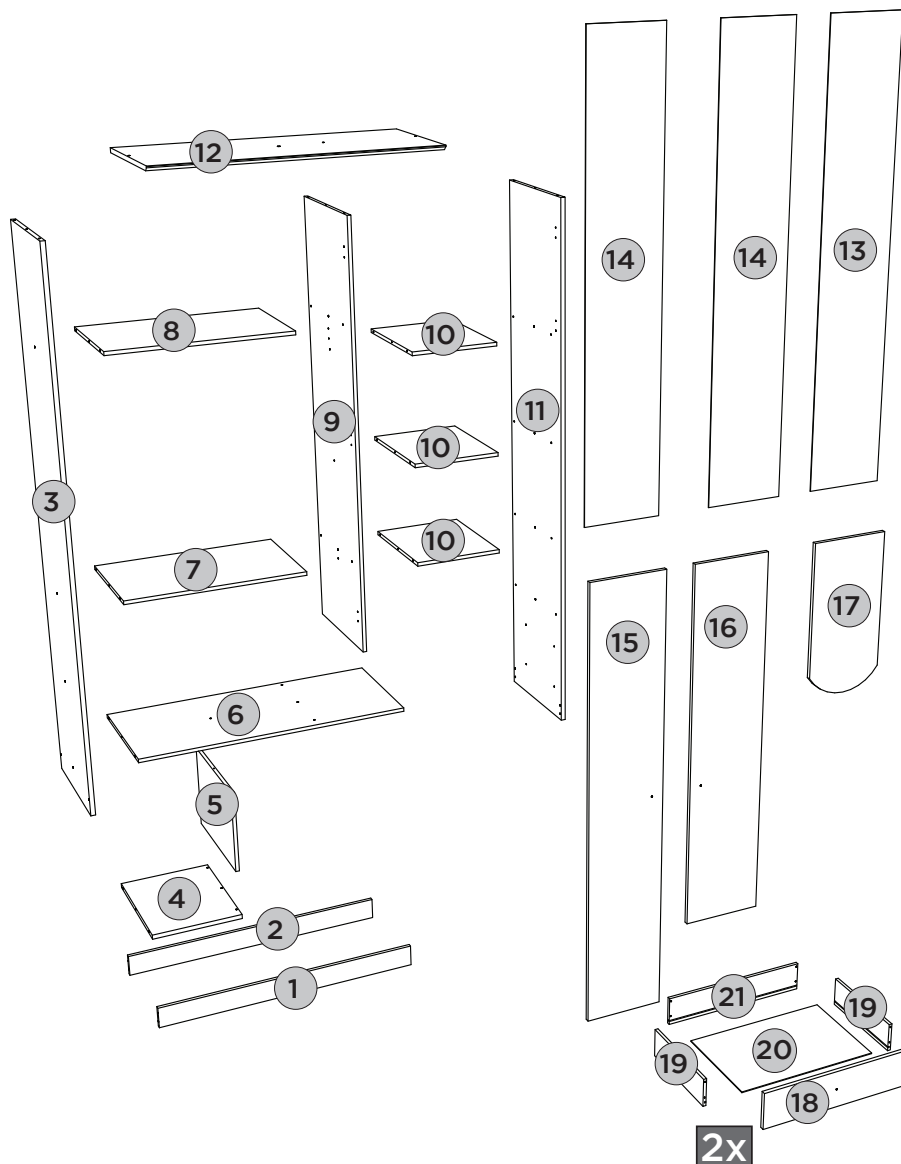

**REQUISITOS PARA MONTAGEM**  
**REQUISITOS PARA LA MONTAJE | ASSEMBLY REQUIREMENTS.**

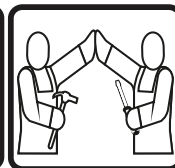
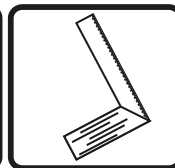
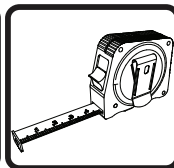
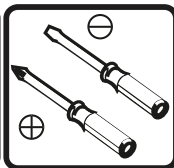
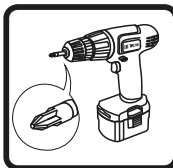





Imagens meramente ilustrativas, não acompanha o produto.  
 Imágenes ilustrativas, no incluidas con el producto.  
 Illustrative images, not included with the product.

**PEÇAS REQUERIDAS**

1	RODAPÉ FRONTAL	x1
2	RODAPÉ TRASEIRO	x1

**ACESSÓRIOS REQUERIDOS**

F		04
G		02
O		02
V		

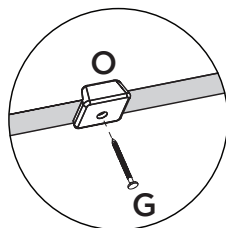
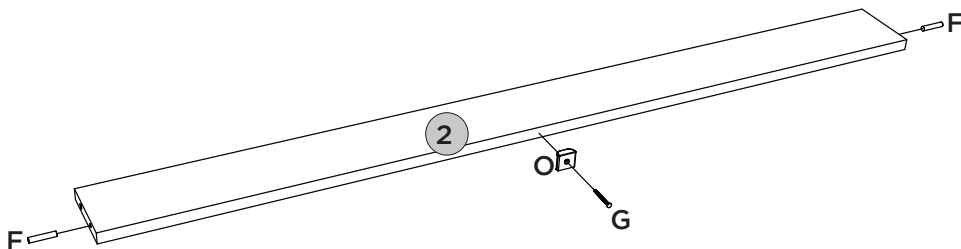
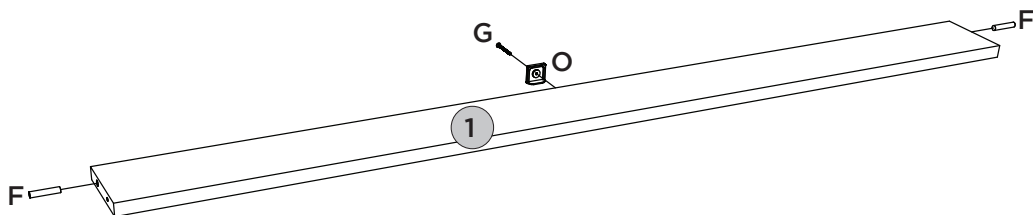
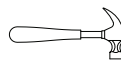
**FERRAMENTAS NECESSÁRIAS**

**PEÇAS REQUERIDAS**

3	LATERAL ESQUERDA	x1
5	DIVISÃO MENOR	x1
9	DIVISÃO	x1
11	LATERAL DIREITA	x1

**ACESSÓRIOS REQUERIDOS**

D		32
F		12
G		04
M		04
O		04

**FERRAMENTAS NECESSÁRIAS**

Q		02
S		08
V		

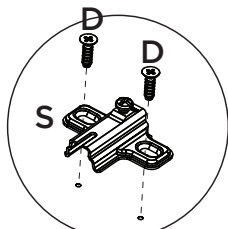
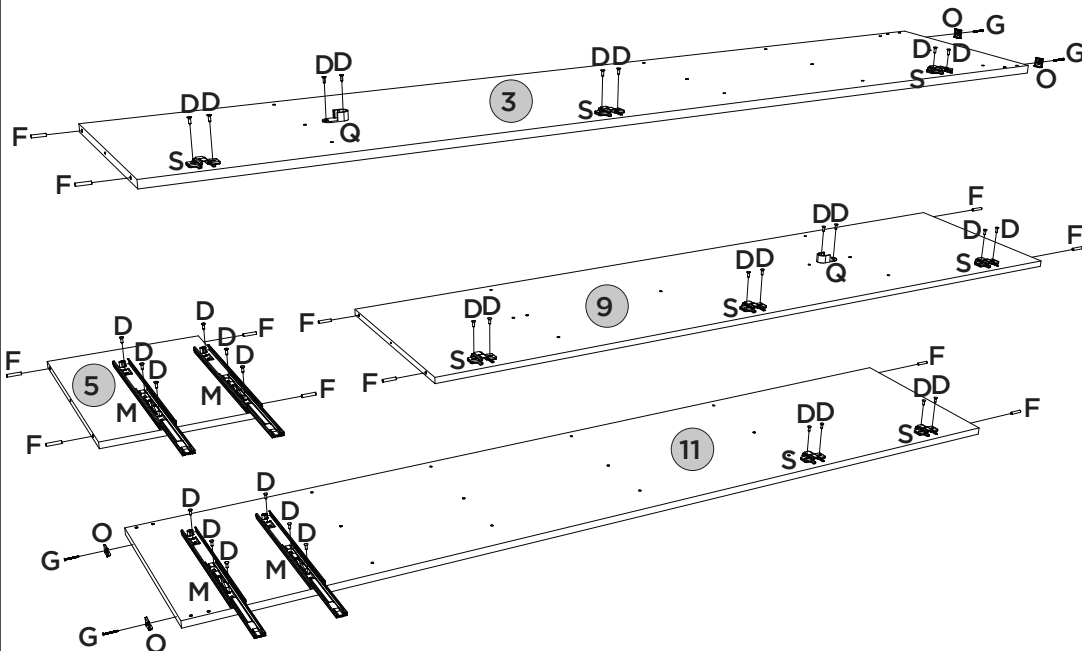

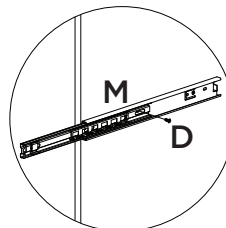
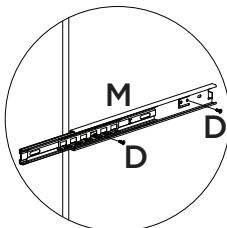
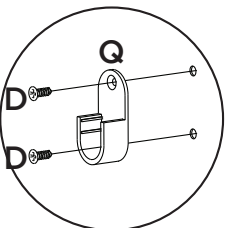
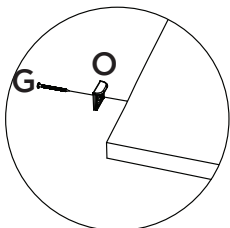
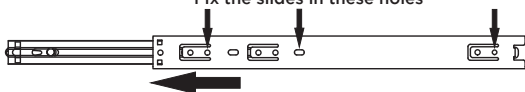

Fixar as correções nessas furações  
Fijar las dispositivos de estos agujeros  
Fix the slides in these holes



**PEÇAS REQUERIDAS**

4	BASE	x1
6	TAMPO DAS GAVETAS	x1
7	PRATELEIRA INFERIOR	x1
8	PRATELEIRA MAIOR	x1
10	PRATELEIRA EXTERNA	x3
19	LADO DE GAVETA	x4

**ACESSÓRIOS REQUERIDOS**

F		42
V		



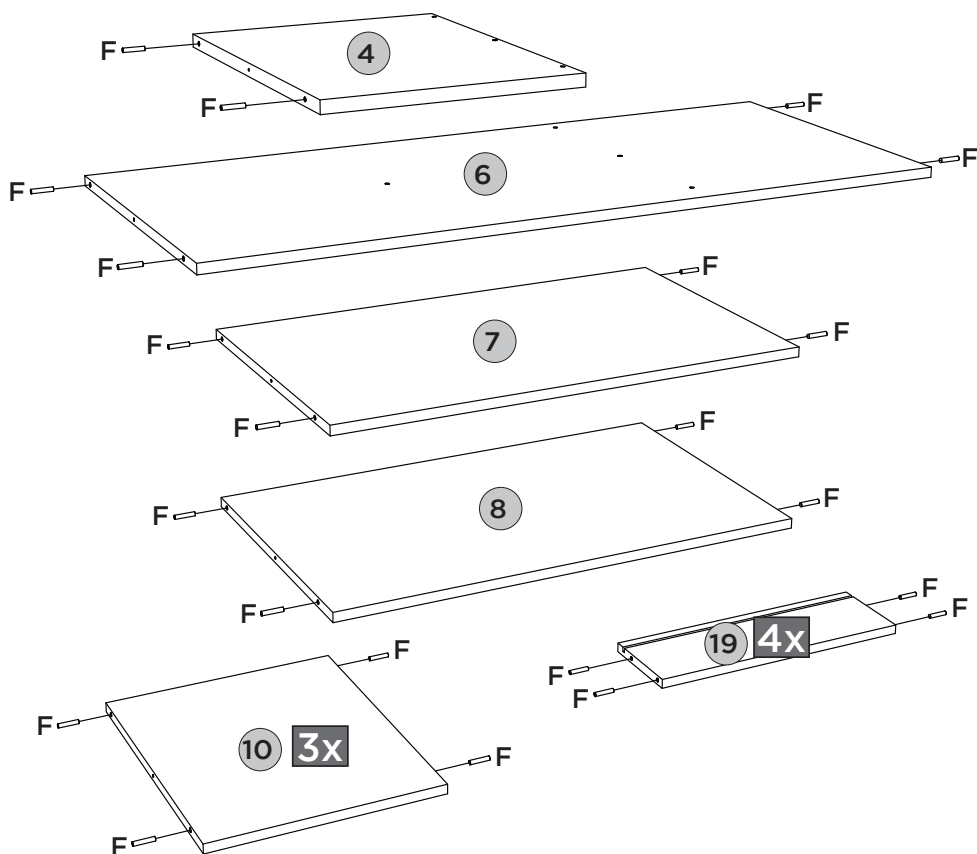

**FERRAMENTAS NECESSÁRIAS**



## PEÇAS REQUERIDAS

15	RODAPÉ FRONTAL	x1
16	RODAPÉ TRASEIRO	x1
17	TRAVESSA ESTRUTURAL	x1

## ACESSÓRIOS REQUERIDOS

C		02
D		16
N		02
T		06

## FERRAMENTAS NECESSÁRIAS

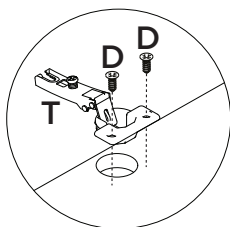
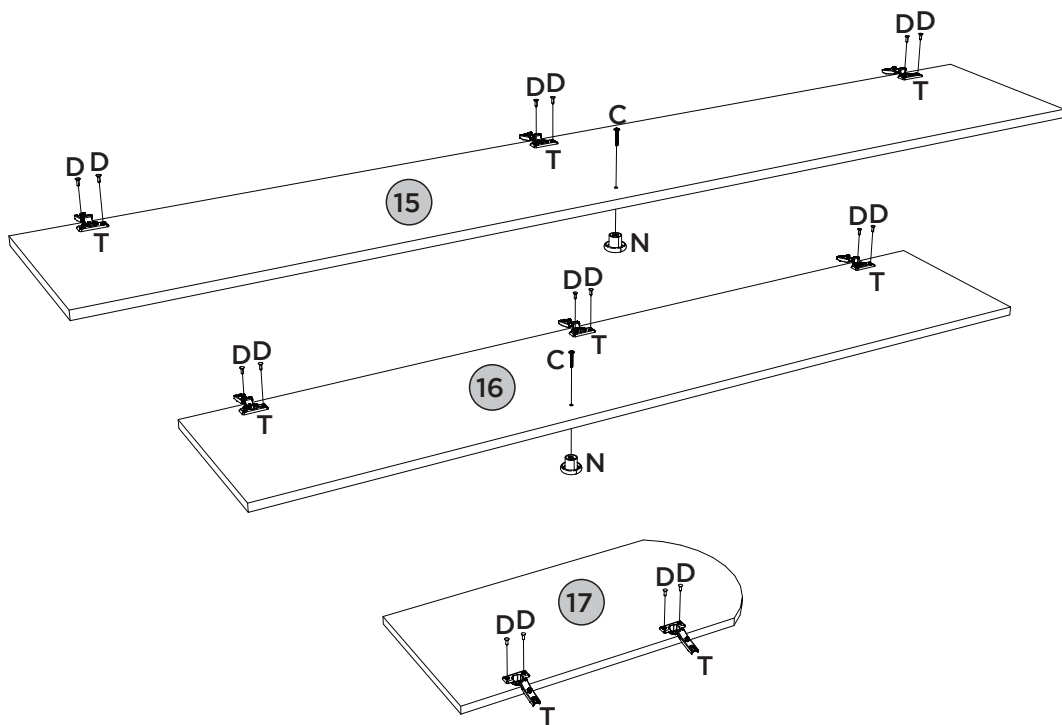
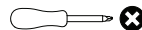

**PEÇAS REQUERIDAS**

1	RODAPÉ FRONTAL	x1
2	RODAPÉ TRASEIRO	x1
3	LATERAL ESQUERDA	x1

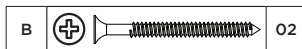
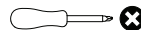
**ACESSÓRIOS REQUERIDOS**

**FERRAMENTAS NECESSÁRIAS**

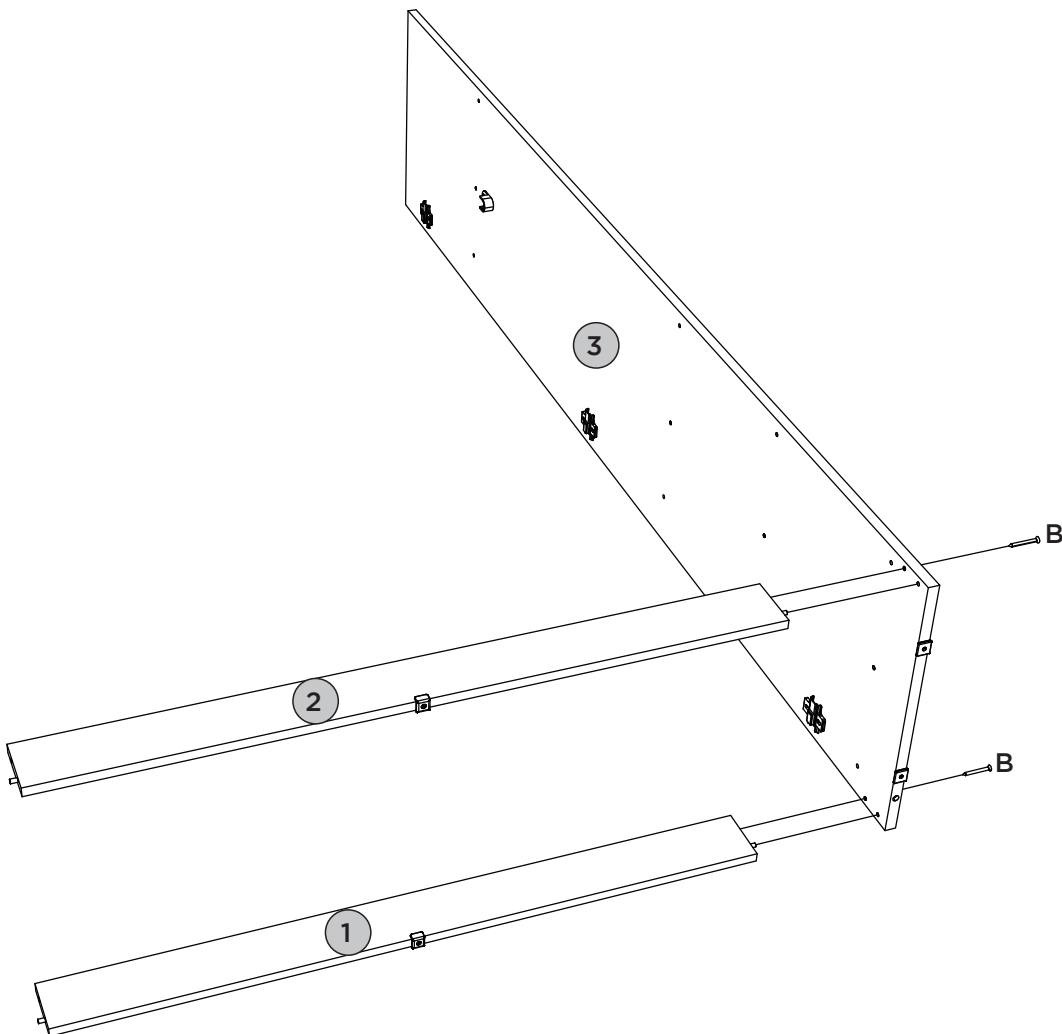
## VISTA TRASEIRA

**1º**

**PEÇAS REQUERIDAS**

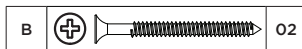
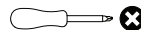
4	LATERAL ESQUERDA	x1
5	RODAPÉ FRONTAL	x1

**ACESSÓRIOS REQUERIDOS**

**FERRAMENTAS NECESSÁRIAS**

## VISTA TRASEIRA

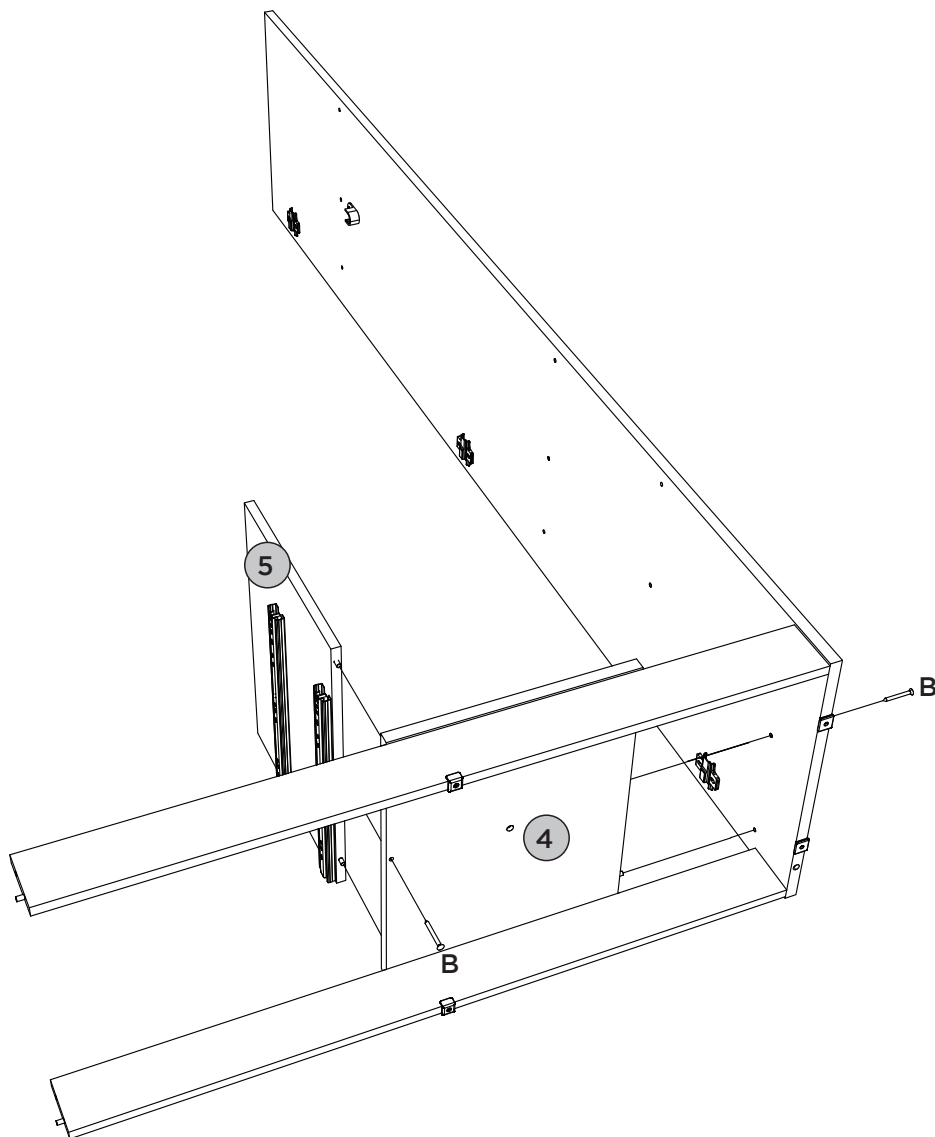

### 2º



PEÇAS REQUERIDAS

6	TAMPO DAS GAVETAS	x1
---	-------------------	----

ACESSÓRIOS REQUERIDOS

B		02
D		04
J		02

FERRAMENTAS NECESSÁRIAS

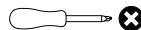

**VISTA TRASEIRA**

3º

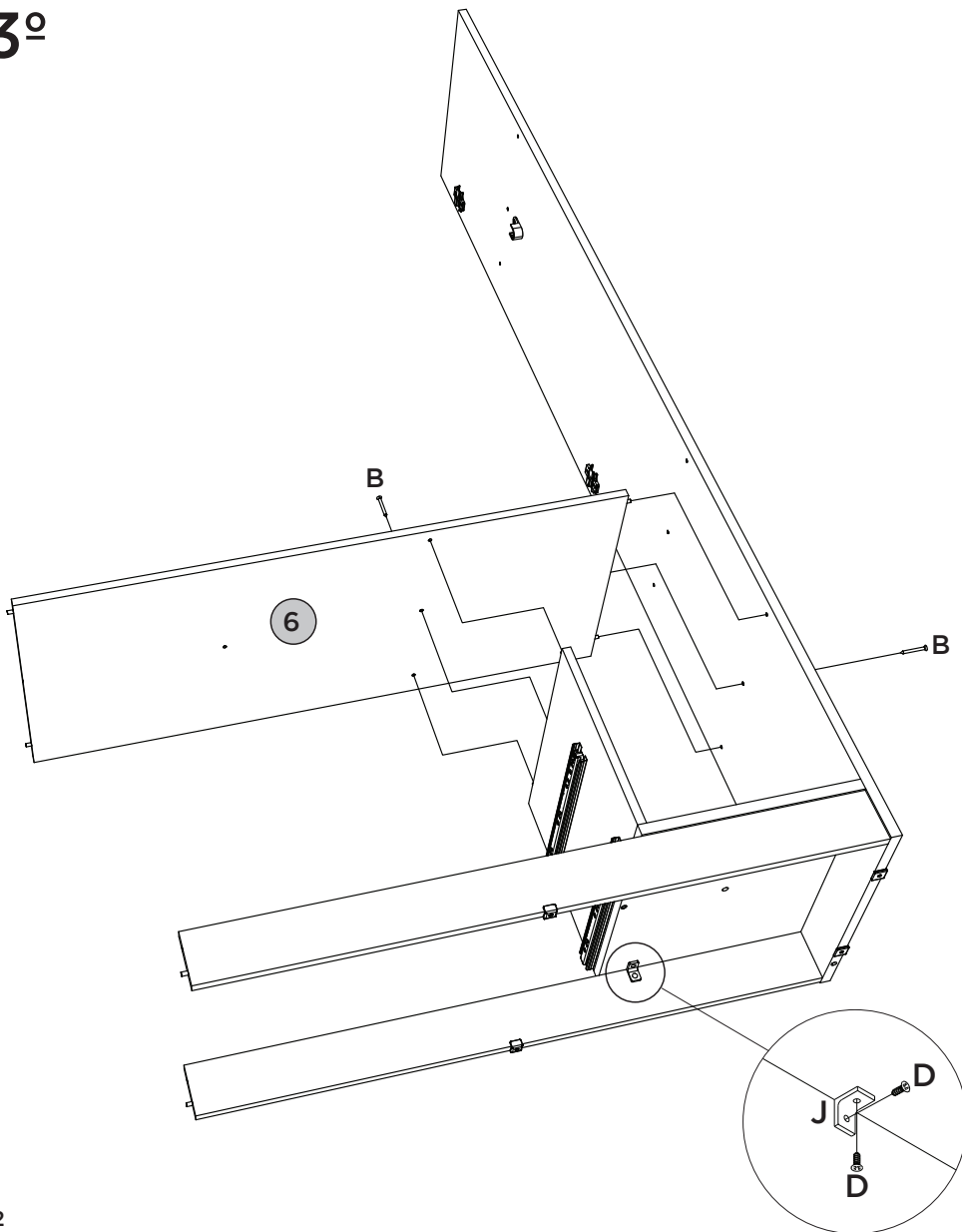

**PEÇAS REQUERIDAS**

7	PRATELEIRA INFERIOR	x1
8	PRATELEIRA MAIOR	x1
9	DIVISÃO	x1

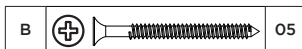
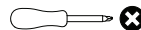
**ACESSÓRIOS REQUERIDOS**

**FERRAMENTAS NECESSÁRIAS**

## VISTA TRASEIRA

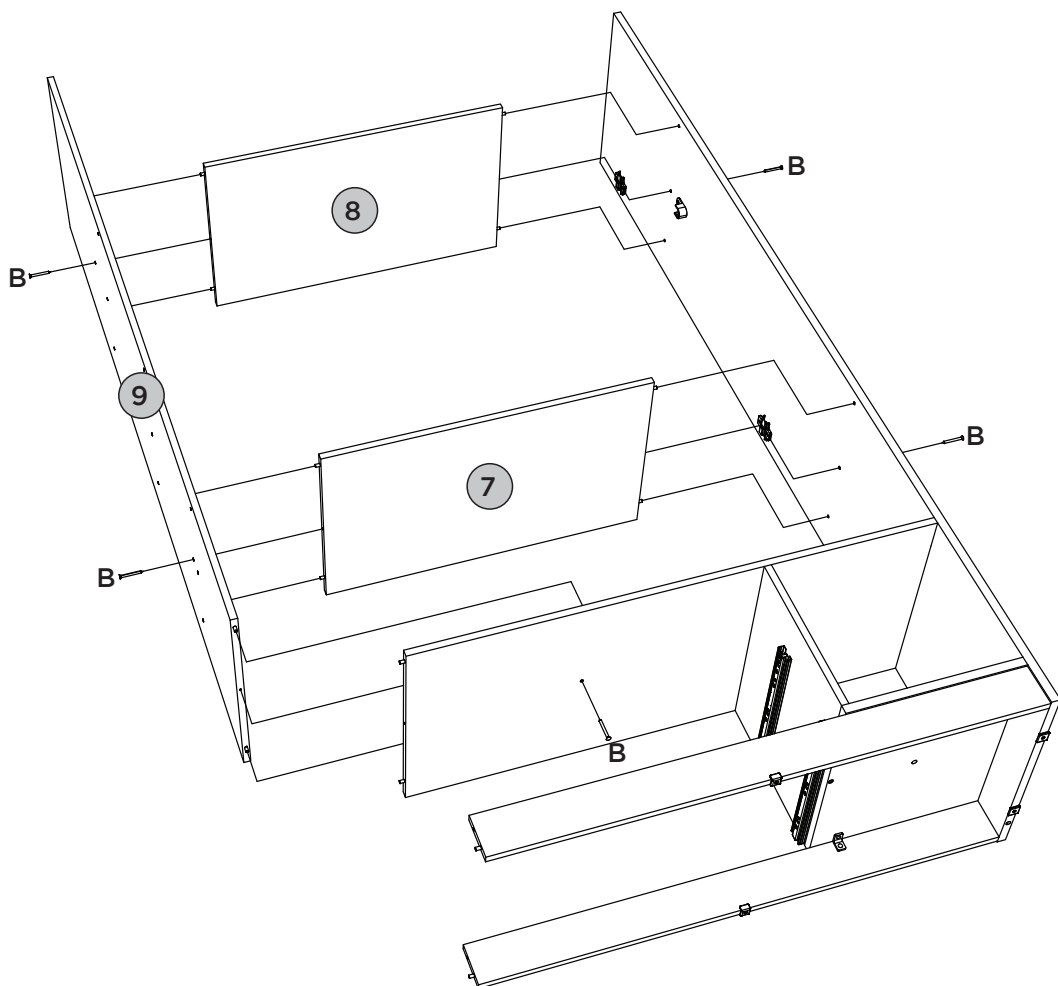
### 4º



**PEÇAS REQUERIDAS**

10	PRATELEIRA EXTERNA	x3
11	LATERAL DIREITA	x1
12	TAMPO	x1

**ACESSÓRIOS REQUERIDOS**

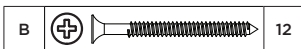

**FERRAMENTAS NECESSÁRIAS**

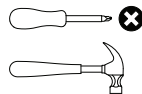

**5º**

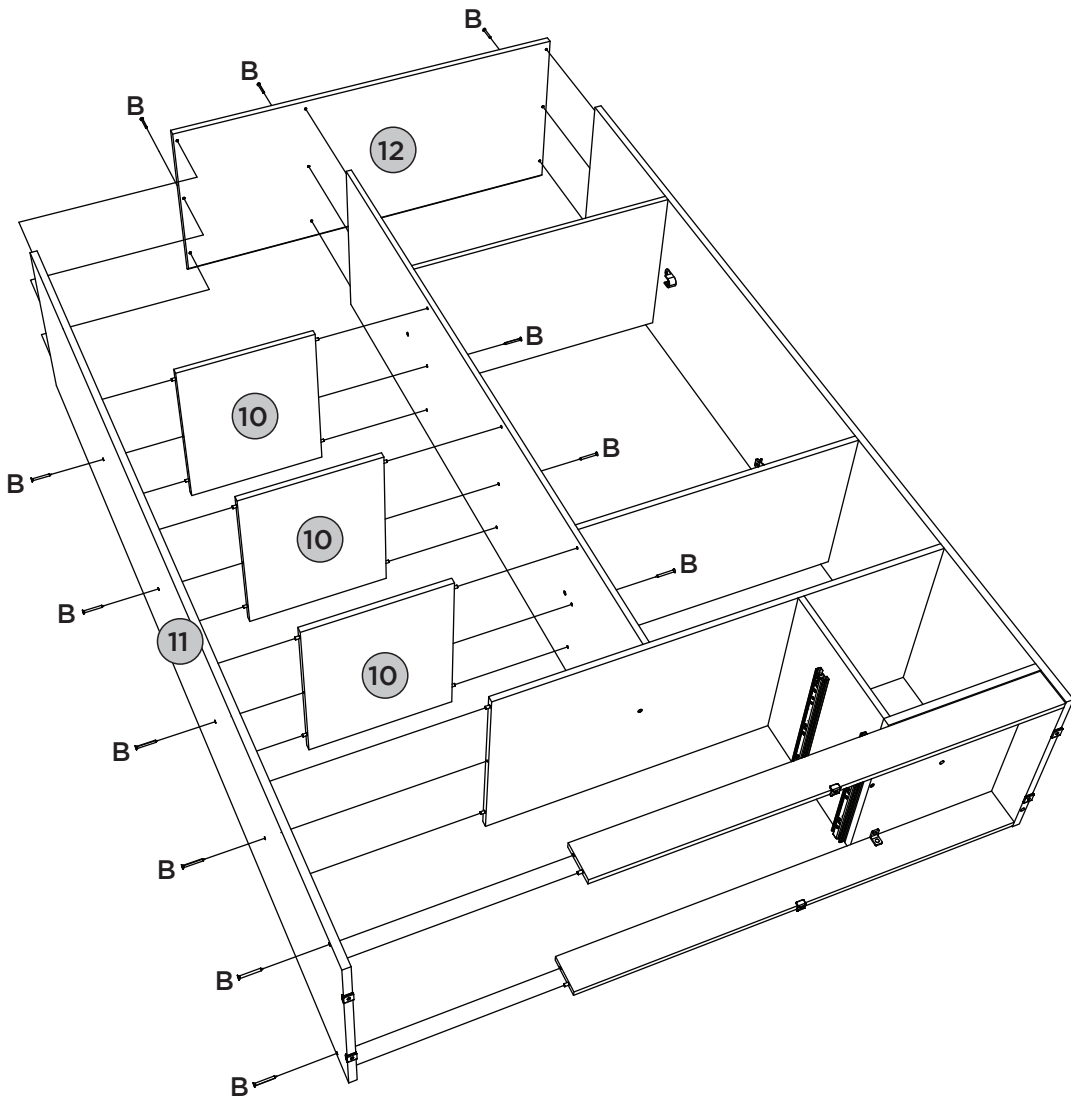

**VISTA TRASEIRA**



**PEÇAS REQUERIDAS**

13	FUNDO EXTERNO	x1
14	FUNDO	x2

**ACESSÓRIOS REQUERIDOS**

H		85
I		15
P		01

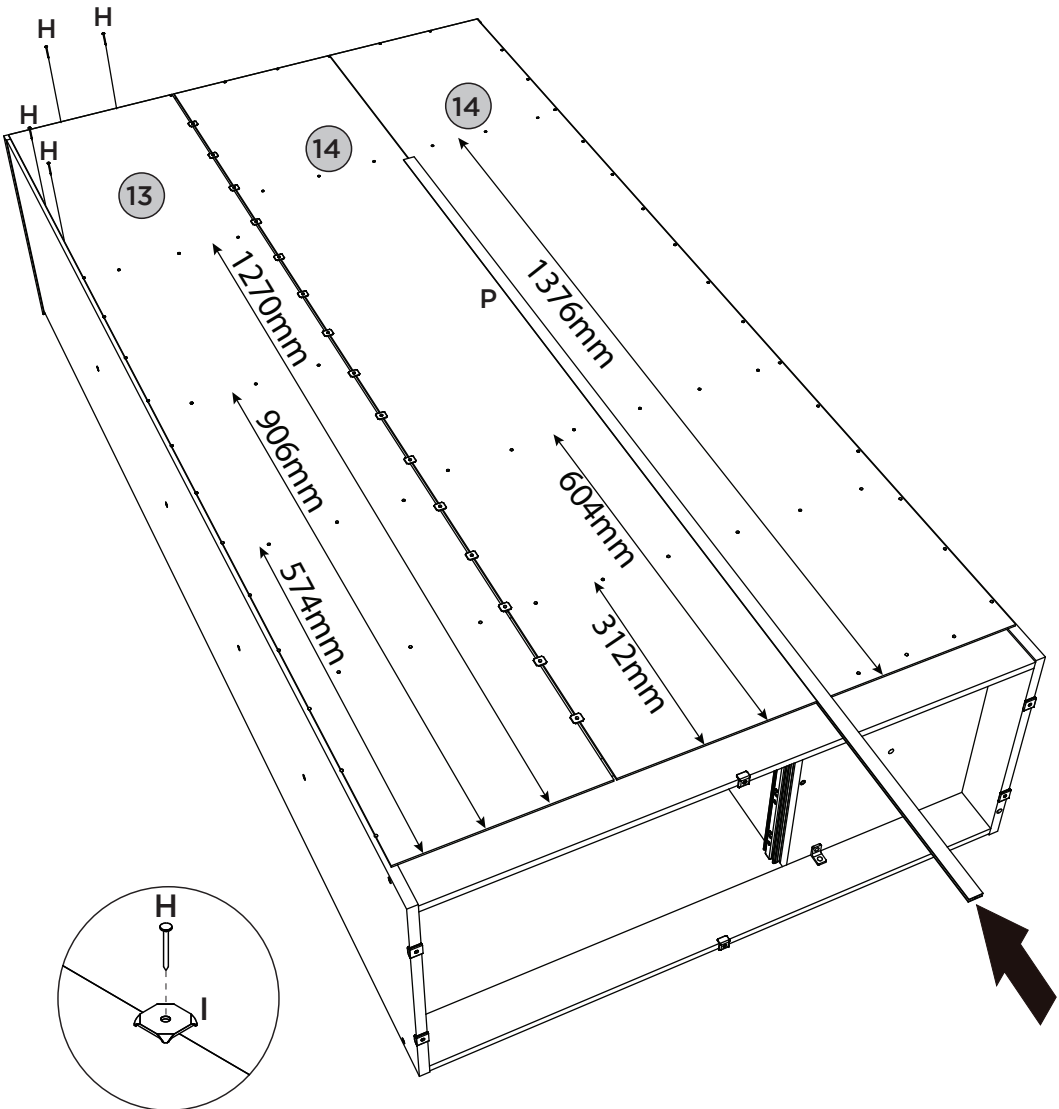

**FERRAMENTAS NECESSÁRIAS**

**6º**
**VISTA TRASEIRA**

**PEÇAS REQUERIDAS**

8	TAMPO	x1
9	FUNDO SUPERIOR	x1
10	FUNDO CRU	x2

**ACESSÓRIOS REQUERIDOS**

D		02
P		01
R		01

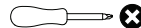
**FERRAMENTAS NECESSÁRIAS**

## 7º

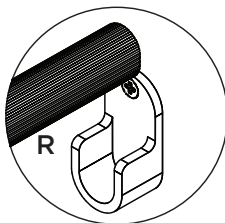
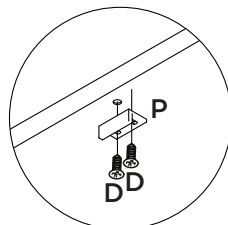
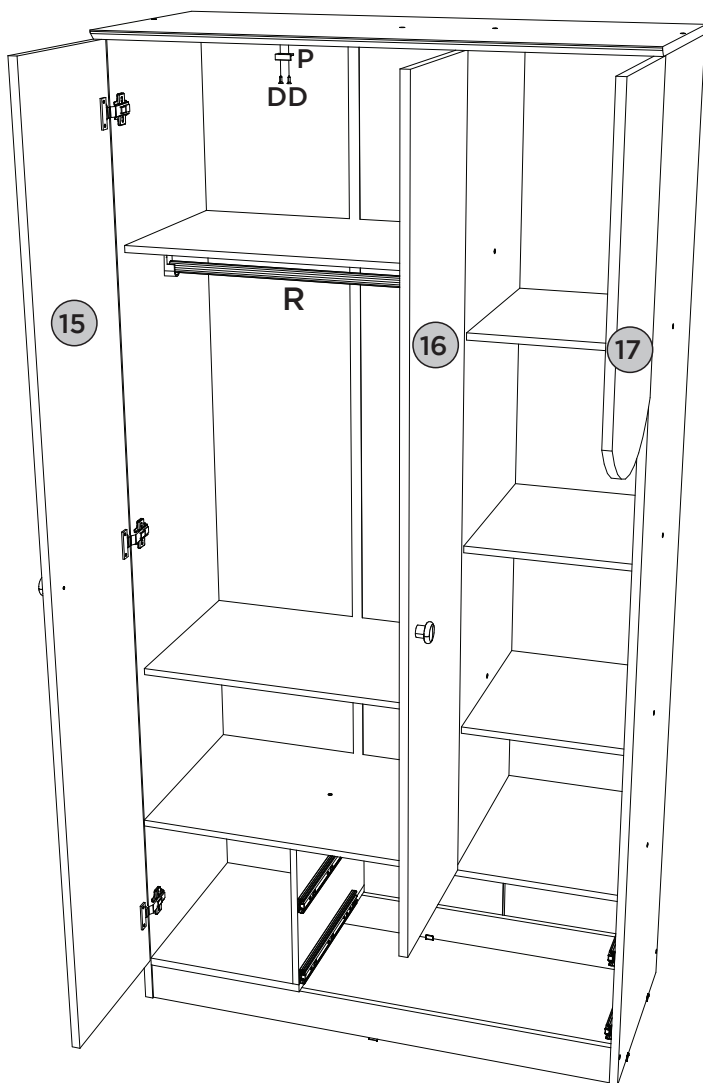

Parafusos indicados na imagem, devem ser inseridos, caso venham soltos no pacote.

Los tornillos indicados en la imagen deben ser insertados, si se sueltan en el paquete.

Screws indicated in the image must be inserted if they are loose in the package.

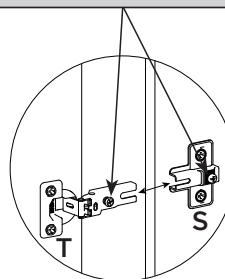

Video: Instalar e regular Dobradiças

Video: Instale y ajuste las bisagras

Video: Install and adjust hinges







# MONTAGEM 8, 9 E 10 | MONTAJE 8, 9 Y 10 | ASSEMBLY 8, 9 AND 10

## PEÇAS REQUERIDAS

18	FRENTE DE GAVETA	x2
19	LADO DE GAVETA	x4
20	FUNDO DE GAVETA	x2
21	RIPA DE TRÁS	x2

## ACESSÓRIOS REQUERIDOS

D		08
G		04
J		04
V		

## FERRAMENTAS NECESSÁRIAS

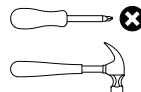

### 8º 2x

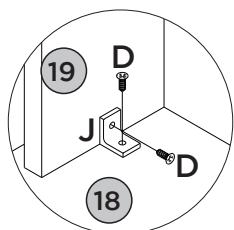
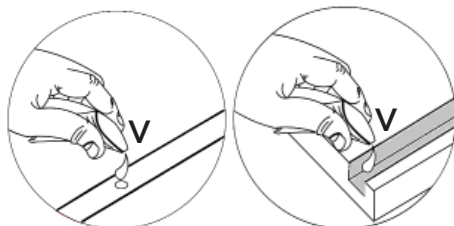
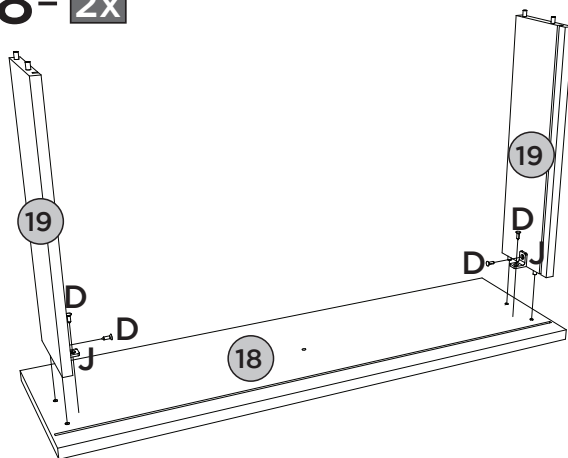



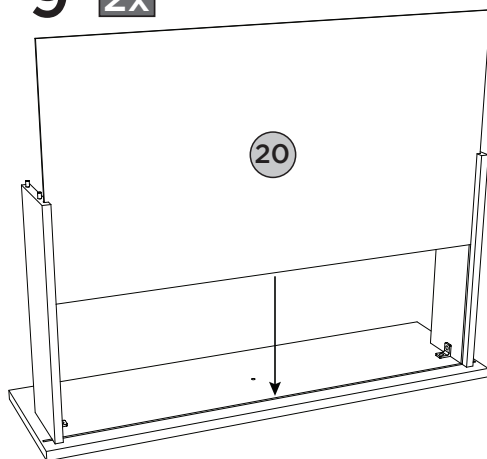

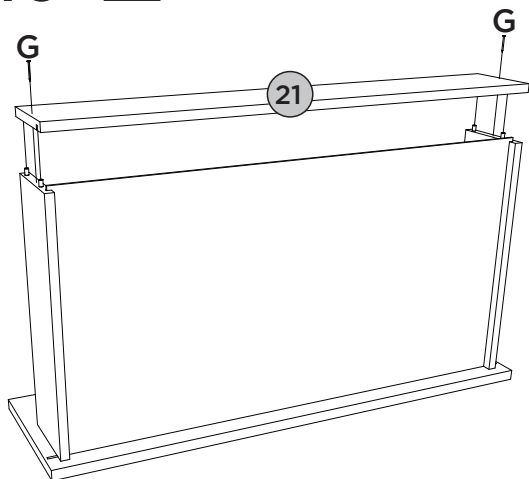

### 9º 2x







### 10º 2x



ACESSÓRIOS REQUERIDOS

C			02
D			12
E			04
L			04

FERRAMENTAS NECESSÁRIAS

		
M		04
N		02

11º 2x

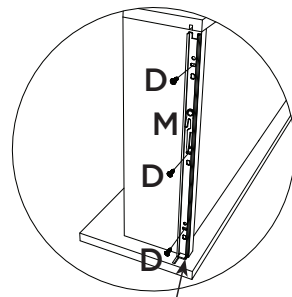
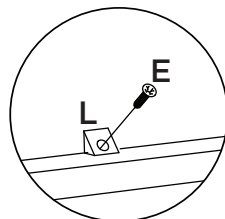
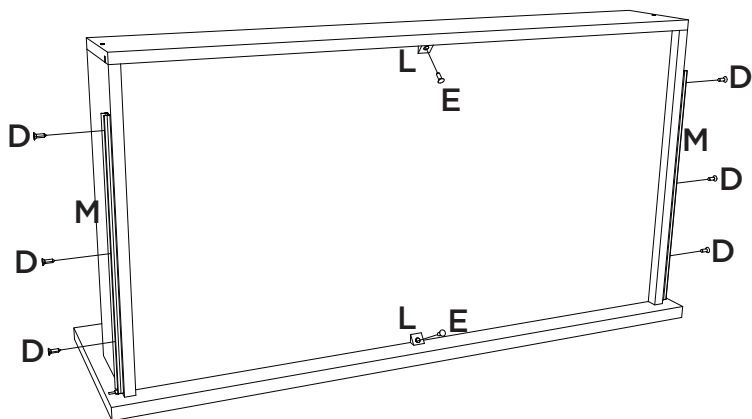

Deixar 3mm de distância da frente de gaveta.



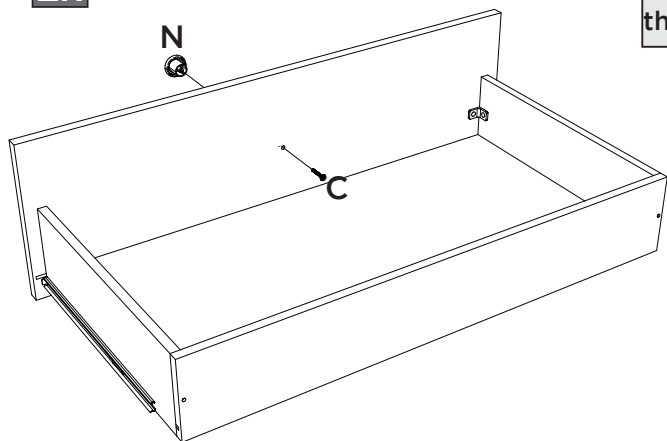

Deje una separación de 3mm del frente del cajón.

Leave 3mm away from the front of the drawer.





12º 2x



**ACESSÓRIOS REQUERIDOS**

A		01
D		02
K		01
W		20

**FERRAMENTAS NECESSÁRIAS**

		
X		03
Y	<b>HENN</b>	01
Z		01

**13º**

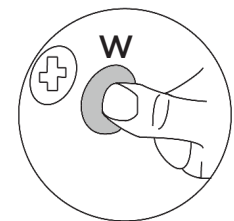
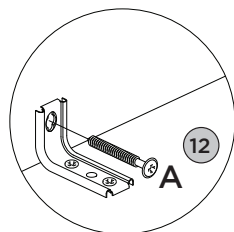
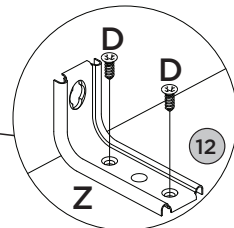
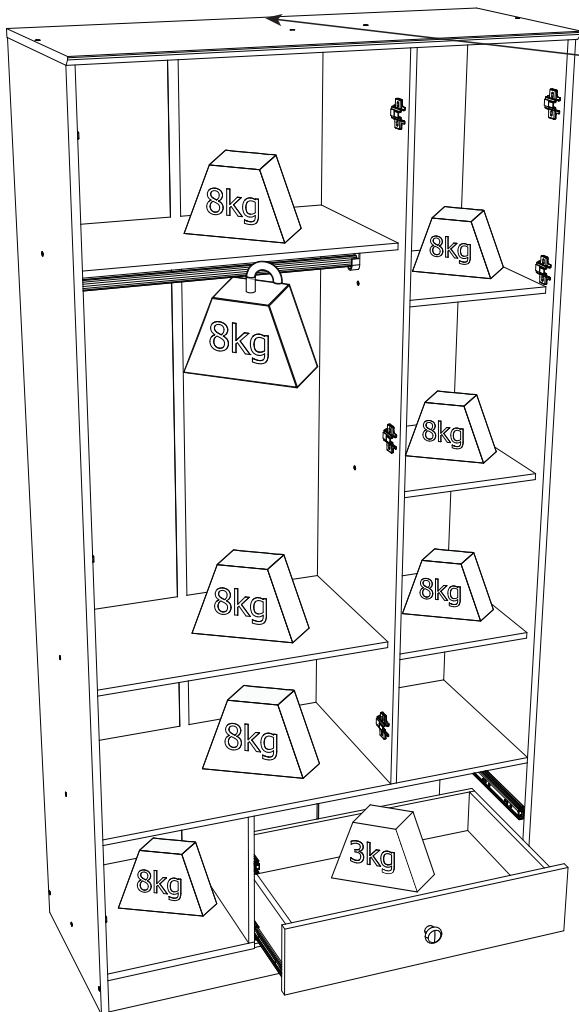

**PERFECT CORRECTION  
CORRECCIÓN PERFECTA**

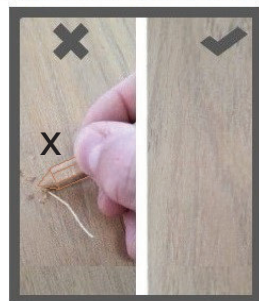

**Pesos máximos recomendados con carga distribuída.  
Peso máximo recomendado con la carga distribuída.  
Recommended maximum weights with evenly distributed.**

**PRODUTO CONCLUÍDO**  
**PRODUCTO TERMINADO**  
**FINISHED PRODUCT**

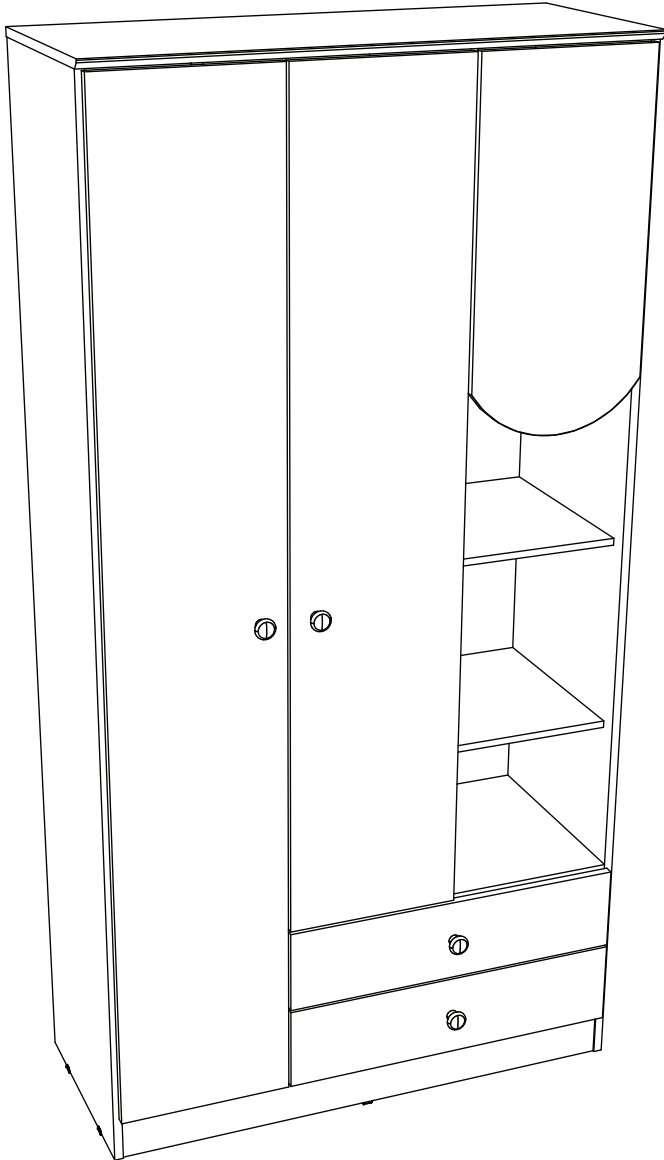

**HENN**Ind. e Com. de Móveis Henn  
Mondai - SC - Brasil

☎ +55 49 3674.3500

📱 @moveishenn  
www.henn.com.br**INSTRUÇÕES DE  
MONTAGEM****INSTRUCCIONES DE MONTAJE  
ASSEMBLY INSTRUCTIONS****CÔMODA MAGIA 03 GAVETAS |  
CÓMODA MAGIA 03 CAJONES | MAGIA CHEST OF DRAWERS 03**

I726-190 Branco/Jequitibá HP

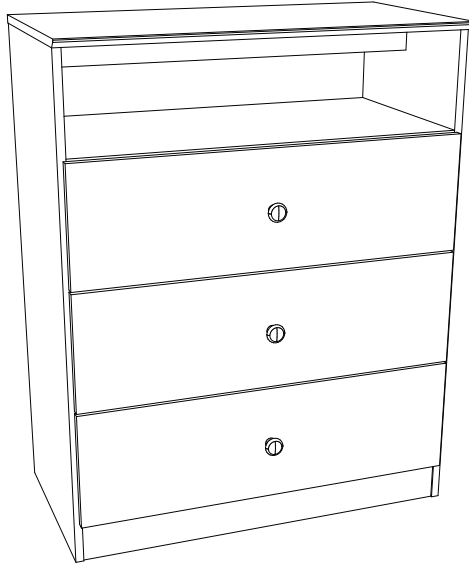
**AVISO**

Para limpeza de seu móvel, use uma flanela seca ou umedecida, e não utilize produtos químicos que possam danificar seu produto.

**SISTEMA DE MONTAGEM**

O sistema de montagem dos produtos, funciona de acordo com a ordem crescente dos números indicados no desenho. Ex: 01, 02, 03, 04... até a conclusão da montagem.

**ASSISTÊNCIA TÉCNICA**

Para solicitação de Assistência Técnica você consumidor deverá entrar em contato com o Lojista o qual você realizou a compra deste produto e solicitar a assistência técnica das peças avariadas. A garantia abrange todas as peças, partes e componentes que eventualmente venham apresentar defeito de fabricação no prazo de 03 (três) meses, contando a partir da entrega do produto ao consumidor, mediante nota fiscal de compra. Se houver qualquer alteração na estrutura do produto ou ocorrer defeito por negligência do montador/consumidor em relação a instrução de montagem e manuseio, não será fornecido assistência técnica gratuita.

**ADVERTENCIA**

Para limpieza de su móbil, use una flanela seca o húmeda, y no utilice productos químicos que puedan dañar su producto.

**SISTEMA DE MONTAJE**

El sistema de montaje de los productos funciona de acuerdo con el orden creciente de los números indicados en el dibujo. Ej.: 01, 02, 03, 04... hasta la conclusión del montaje.

**ASISTENCIA TÉCNICA**

Para solicitar Asistencia Técnica, el consumidor debe comunicarse con el Comercio que usted realizó la compra de este producto y solicita asistencia técnica para las partes dañadas. La garantía cubre todas las partes, piezas y componentes que eventualmente puedan presentar defecto de fabricación en el plazo de 03 (tres) meses, contados a partir de la entrega del producto al consumidor, mediante factura de compra. Si se produce algún cambio en la estructura del producto o se produce un defecto por negligencia del montador/consumidor en relación con las instrucciones de montaje y manipulación, no se prestará asistencia técnica gratuita.

**NOTICE**

To clean your furniture, use a dry or wet cloth, and do not use chemicals that may damage your product.

**ASSEMBLY SYSTEM**

The products' assembly system works according to the increasing order of the indicated numbers. For example: 01, 02, 03, 04 ... to the end of the assembly.

**TECHNICAL ASSISTANCE**

To request Technical Assistance, the consumer must contact the retailer from whom you purchased this product and request technical assistance for the damaged parts. The warranty covers all parts, parts and components that may eventually present a manufacturing defect within a period of 03 (three) months, counting from the delivery of the product to the consumer, by means of a purchase invoice. If there is any change in the structure of the product or defect occurs due to negligence of the assembler/consumer in relation to the assembly and handling instruction, free technical assistance will not be provided.

# ACESSÓRIOS | ACCESORIOS | ACCESSORIES

A	x1	B	x8	C	x3	D	x62	E	x6
---	----	---	----	---	----	---	-----	---	----

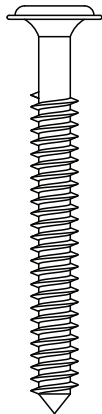

5,0x50mm



3,5x40mm



3,5x25mm



3,5x12mm



3,0x16mm

F	x42	G	x10	H	x34	I	x6	J	x12
---	-----	---	-----	---	-----	---	----	---	-----

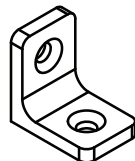
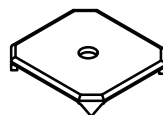
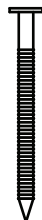
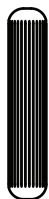

K	x3	L	x6	M	x3	N	x3	O	x4
---	----	---	----	---	----	---	----	---	----

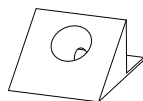
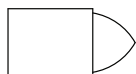

PAR

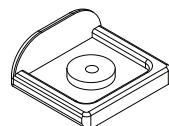

Parafusos em escala

Tornillos escalados

Scaled screws

1:1

# ACESSÓRIOS | ACCESORIOS | ACCESSORIES

P x1 Q x1 R x1 S x1 T x8

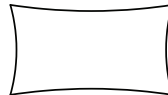
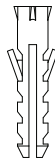
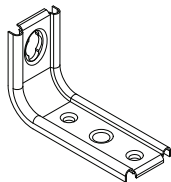

## LISTA DE PEÇAS | LISTA DE PIEZAS | LIST OF PIECES

Item	Caixa Caja Box	Qtd Ctd Qty	Descrição Descripción Description	Dimensões (mm)   Dimensiones (mm)   Dimensions (mm)		
				Comprimento Largo Length	Largura Ancho Width	Espessura Grosor Thickness
1	1/1	1	LATERAL ESQUERDA   LADO IZQUIERDO   LEFT SIDE	929	380	15
2	1/1	1	RODAPÉ FRONTAL   FALDÓN DELANTERO   FRONT SKIRTING	720	73	12
3	1/1	1	RODAPÉ TRASEIRO   PIE TRASERO   REAR SKIRTING BOARD	720	73	12
4	1/1	1	TRAVESSA ESTRUTURAL   VIGA ESTRUTURAL   STRUCTURAL CROSSBOW	720	73	12
5	1/1	1	TAMPO DAS GAVETAS   TAPA DE LOS CAJONES   TOP OF DRAWERS	720	380	15
6	1/1	1	TRAVESSA SUPORTE   BANDEJA DE SOPORTE   SUPPORT CROSSBOW	720	60	15
7	1/1	1	LATERAL DIREITA   LADO DERECHO   RIGHT SIDE	929	380	15
8	1/1	1	TAMPO   TAPA   TOP	752	396	15
9	1/1	1	FUNDO SUPERIOR   FONDO MÁS ALTO   TOP BOTTOM	744	200	3
10	1/1	2	FUNDO CRU   FONDO CRUDO   RAW BOTTOM	682	371	3
11	1/1	3	FRENTE DE GAVETA   FRENTE DEL CAJÓN   DRAWER FRONT	730	220	15
12	1/1	6	LADO DE GAVETA   LATERAL DEL CAJÓN   DRAWER SIDE	350	110	12
13	1/1	3	FUNDO DE GAVETA   FONDO DEL CAJÓN   DRAWER BOTTOM	682	361	3
14	1/1	3	RIPA DE TRÁS   TRAVESAÑO TRASERO   REAR CLAPBOARD	695	110	12

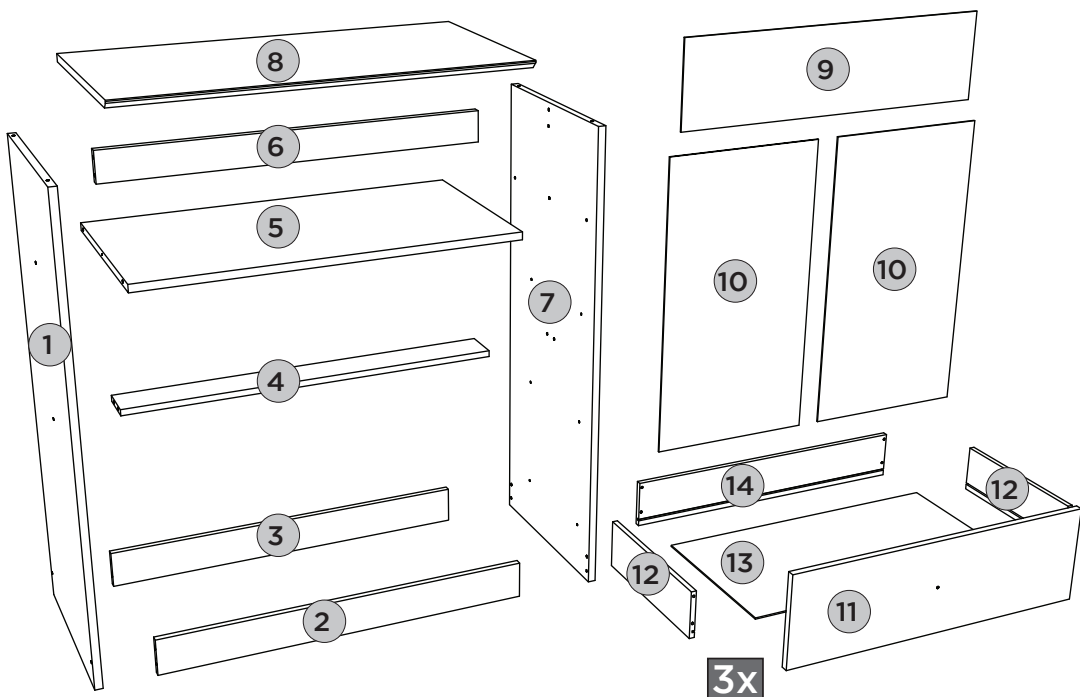

## REQUISITOS PARA MONTAGEM

## REQUISITOS PARA LA MONTAJE | ASSEMBLY REQUIREMENTS.

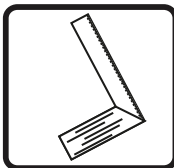
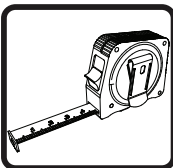
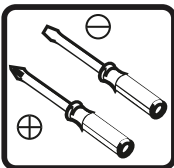
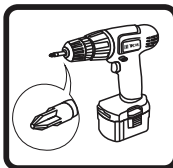

Imagens meramente ilustrativas, não acompanha o produto.





Imágenes ilustrativas, no incluidas con el producto.

Illustrative images, not included with the product.





**PEÇAS REQUERIDAS**

1	LATERAL ESQUERDA	x1
5	TAMPO DAS GAVETAS	x1
7	LATERAL DIREITA	x1
8	TAMPO	x1

**ACESSÓRIOS REQUERIDOS**

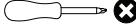
D		22
F		08
G		04
J		04
M		06

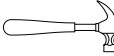
**FERRAMENTAS NECESSÁRIAS**

		
		
O		04
S		

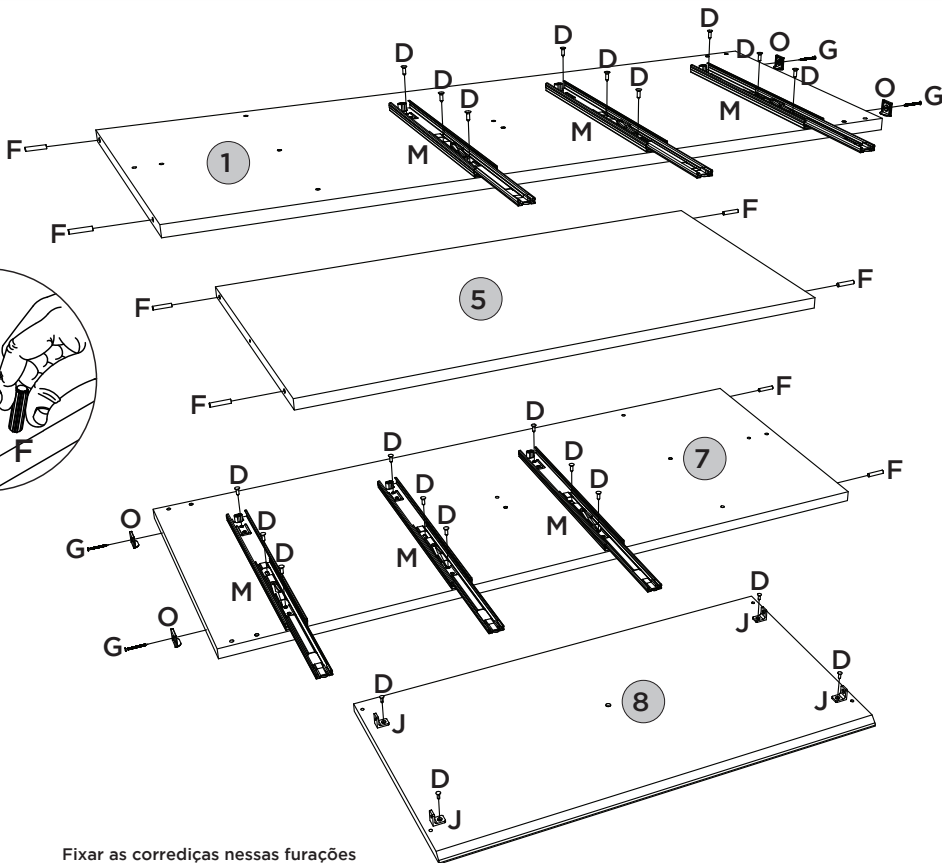



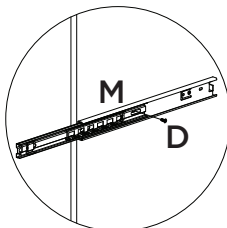
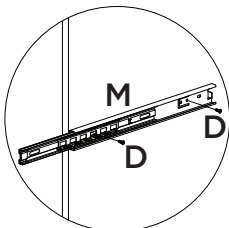
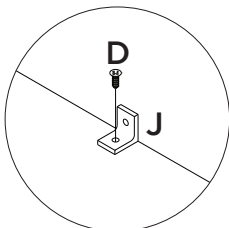
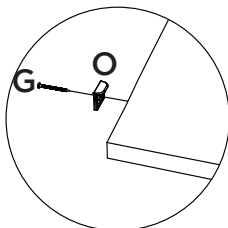
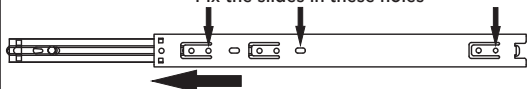

Fixar as corredeiras nessas furações  
 Fijar las diapositivas de estos agujeros  
 Fix the slides in these holes



**PEÇAS REQUERIDAS**

2	RODAPÉ FRONTAL	x1
3	RODAPÉ TRASEIRO	x1
4	TRAVESSA ESTRUTURAL	x1
6	TRAVESSA SUPORTE	x1
12	LADO DE GAVETA	x6

**ACESSÓRIOS REQUERIDOS**

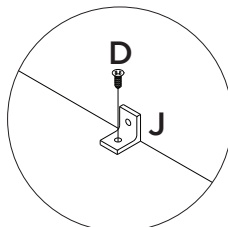
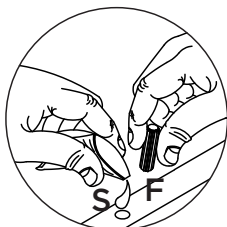
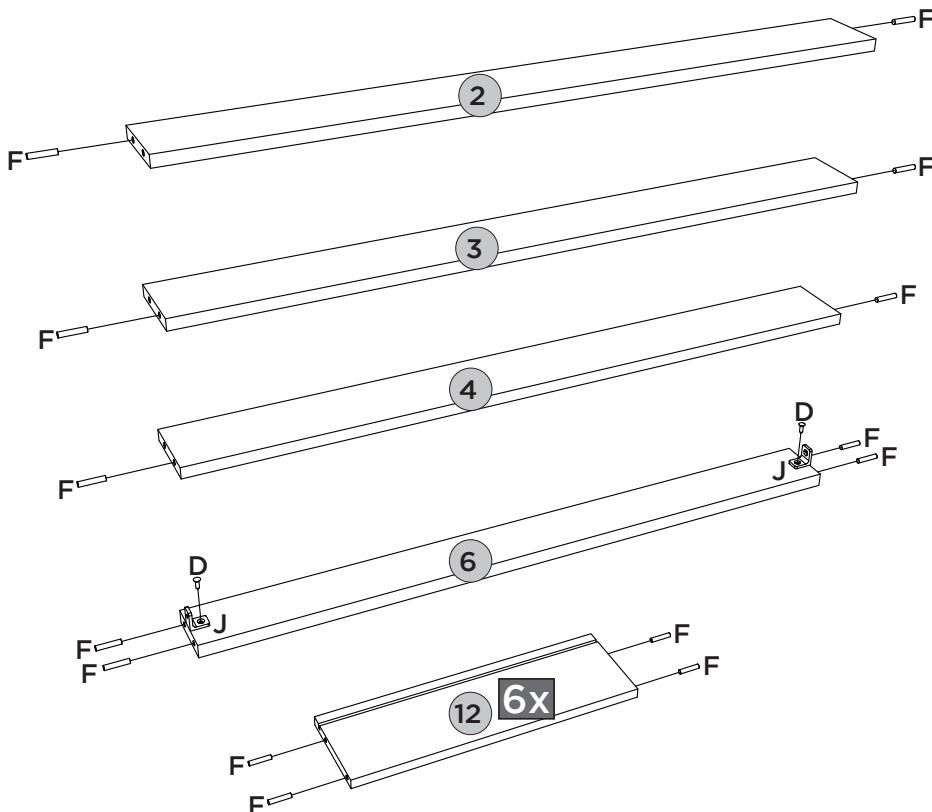
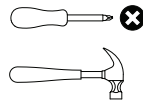

D		02
F		34
J		02
S		

**FERRAMENTAS NECESSÁRIAS**

**PEÇAS REQUERIDAS**

1	LATERAL ESQUERDA	x1
2	RODAPÉ FRONTAL	x1
3	RODAPÉ TRASEIRO	x1
4	TRAVESSA ESTRUTURAL	x1
5	TAMPO DAS GAVETAS	x1
6	TRAVESSA SUPORTE	x1
7	LATERAL DIREITA	x1

**ACESSÓRIOS REQUERIDOS**

B		08
D		02

**FERRAMENTAS NECESSÁRIAS**



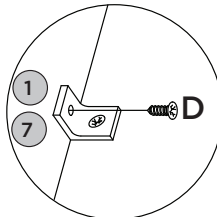
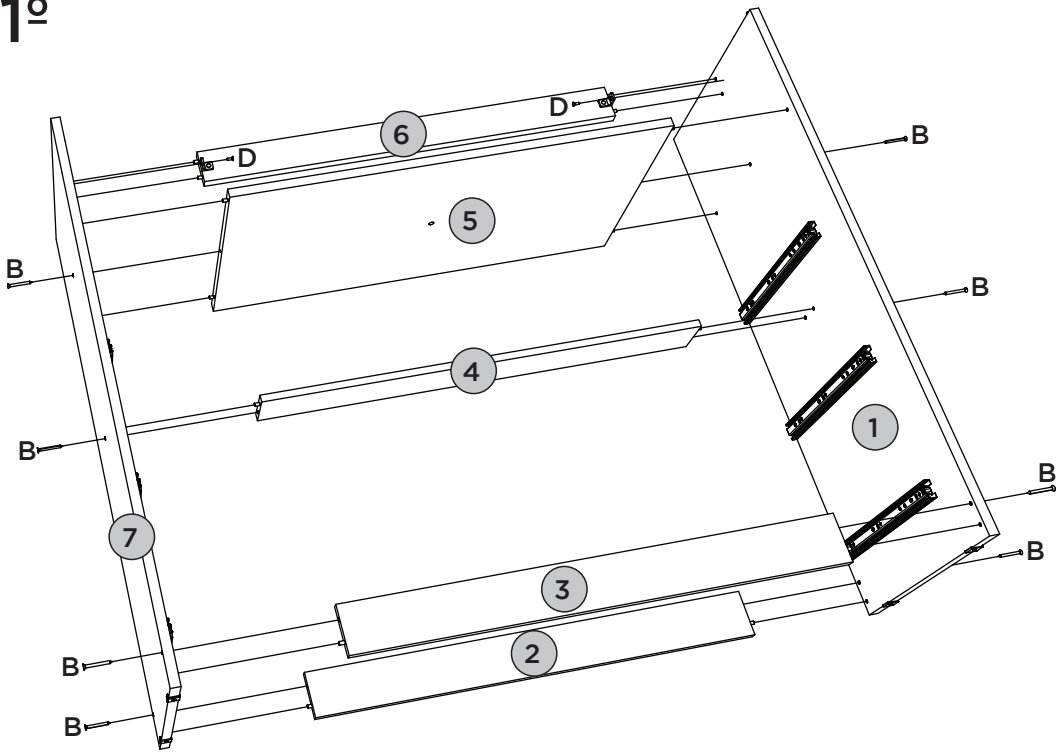

## VISTA TRASEIRA

**1º**

**PEÇAS REQUERIDAS**

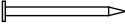
8	TAMPO	x1
9	FUNDO SUPERIOR	x1
10	FUNDO CRU	x2

**ACESSÓRIOS REQUERIDOS**

D		04
H		34
I		06
P		01

**FERRAMENTAS NECESSÁRIAS**

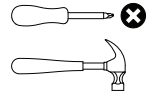

**2º**

**VISTA TRASEIRA**

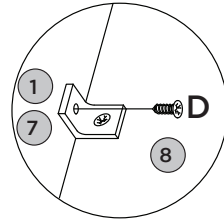
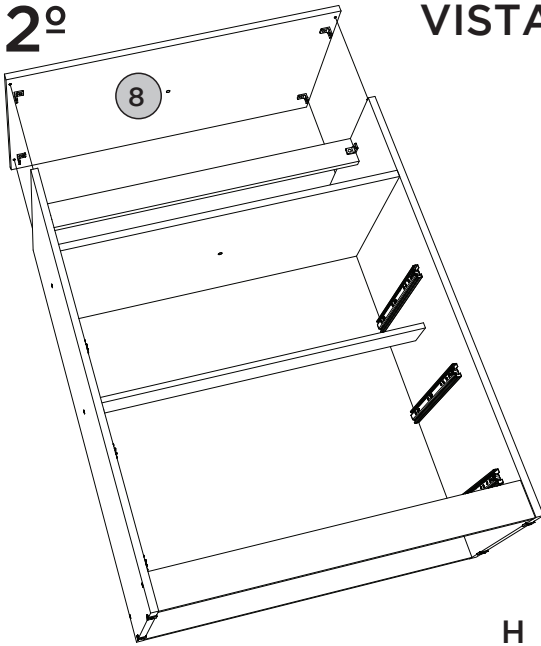



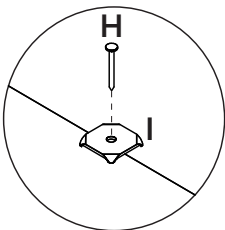
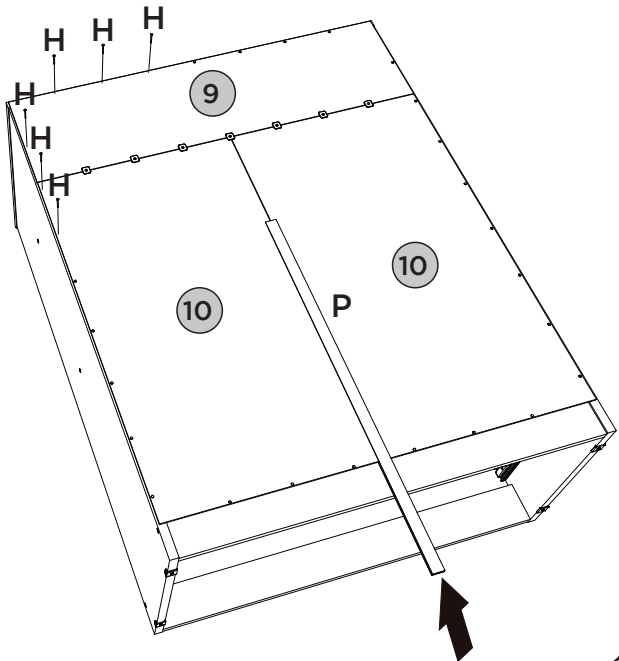

**3º**



**PEÇAS REQUERIDAS**

11	FRENTE DE GAVETA	x3
12	LADO DE GAVETA	x6
13	FUNDO DE GAVETA	x3
14	RIPA DE TRÁS	x3

**ACESSÓRIOS REQUERIDOS**

D		12
J		06
G		06
S		

**FERRAMENTAS NECESSÁRIAS**

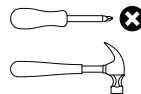

**4º 3x**

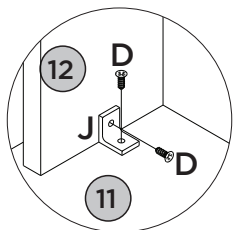
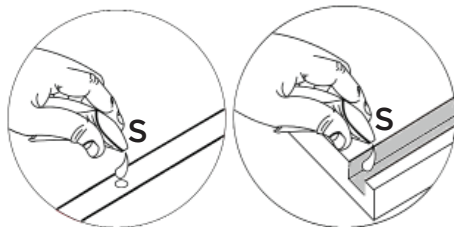
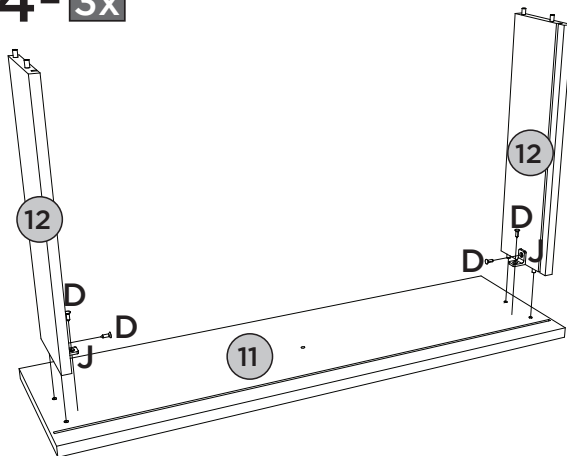



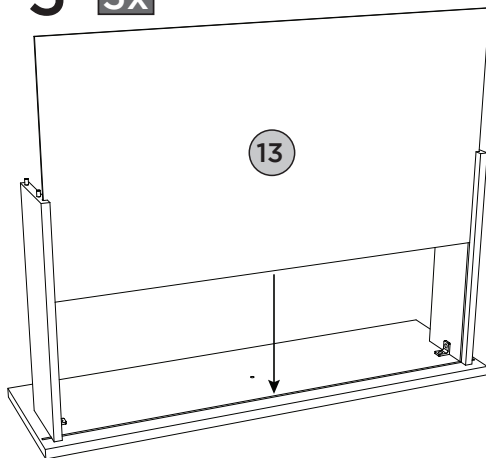

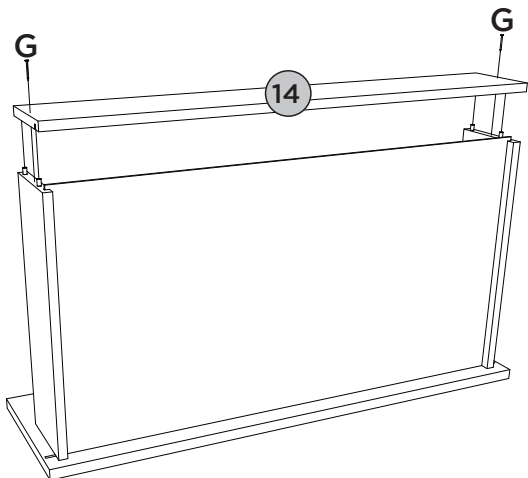

**5º 3x**







**6º 3x**



ACESSÓRIOS REQUERIDOS

C			03
D			18
E			06
L			06

FERRAMENTAS NECESSÁRIAS

		
M		06
N		03

7º 3x

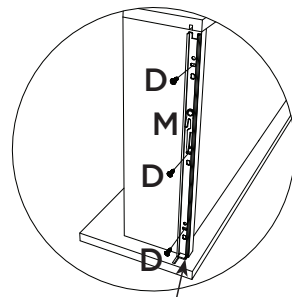
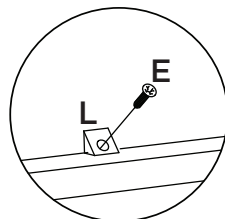
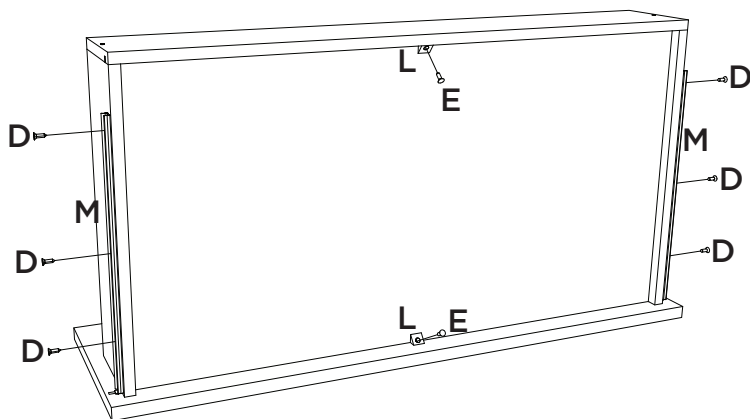

Deixar 3mm de distância da frente de gaveta.







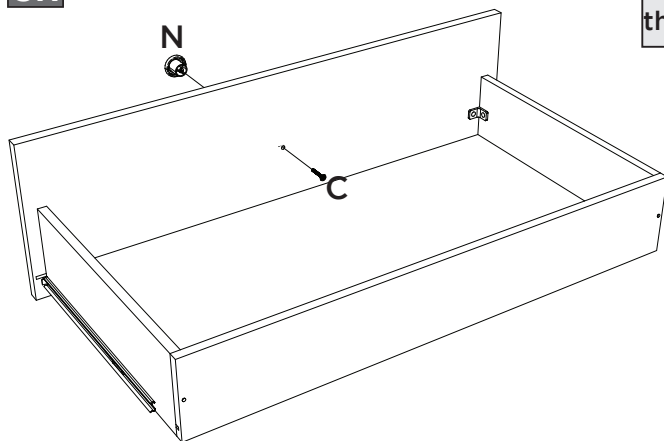

Deje una separación de 3mm del frente del cajón.

Leave 3mm away from the front of the drawer.

8º 3x



**ACESSÓRIOS REQUERIDOS**

A			01
D			02
K			03
Q			01
R			01
T			08

**FERRAMENTAS NECESSÁRIAS**

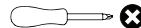

**9º**

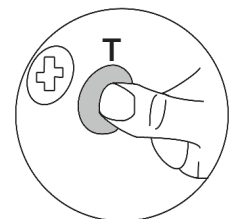
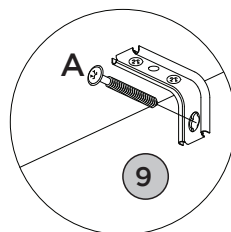
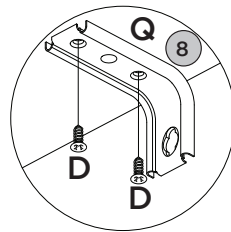

**PERFECT CORRECTION  
CORRECCIÓN PERFECTA**

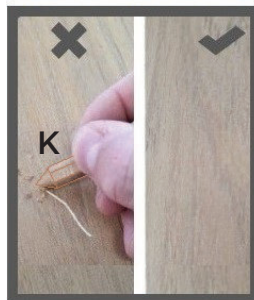

**Pesos máximos recomendados com carga distribuída.  
Peso máximo recomendado con la carga distribuida.  
Recommended maximum weights with evenly distributed.**

PRODUTO CONCLUÍDO  
PRODUCTO TERMINADO  
FINISHED PRODUCT

