

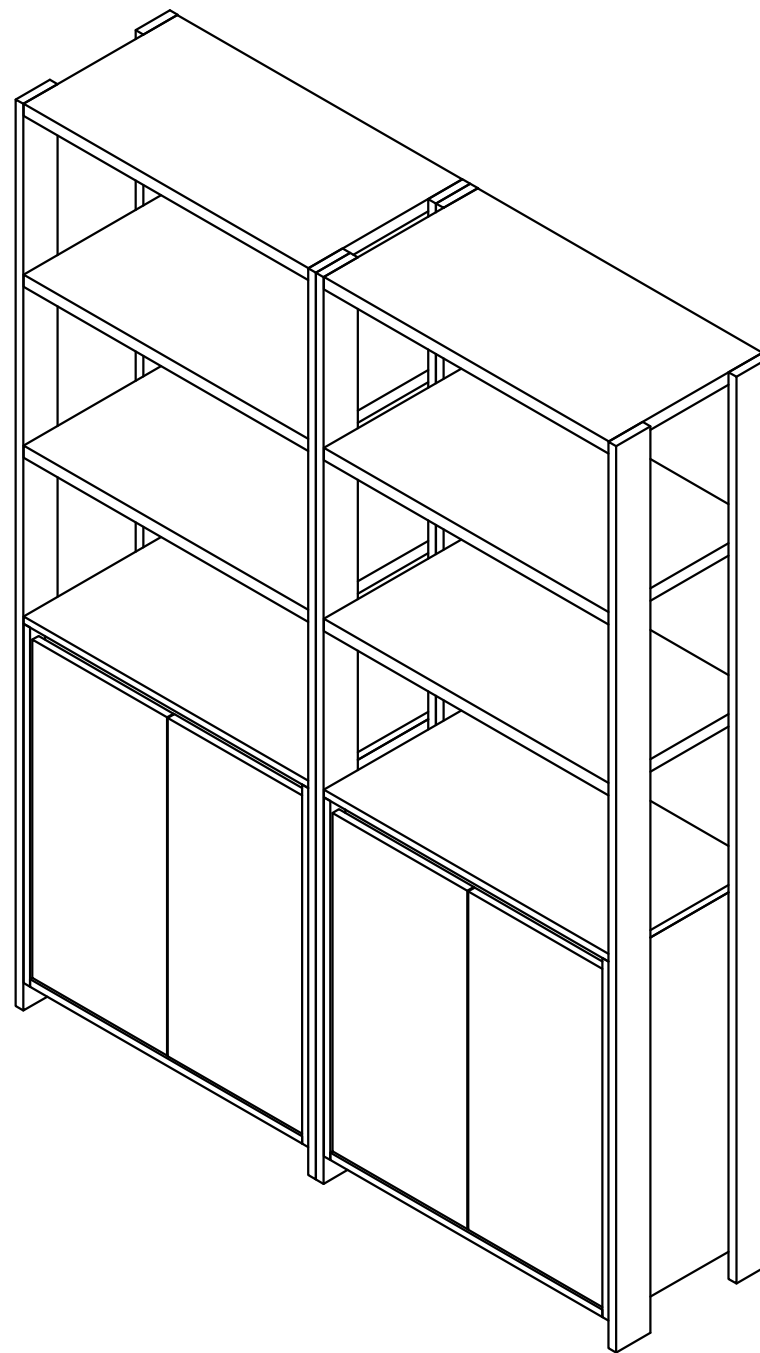













Ref. M114 Conjunto 2x M113



Ref. M113 Estante 2 portas Alt.1830 Larg.700 Prof.360 mm MDP e MDF BP

Ferragem		
A		Cavilha 6 x 50mm 04
B		Cavilha 8 x 30mm 34
C		Parafuso minifix 6 x 32mm 26
D		Tambor 15 x 15mm 26
E		Tampa adesiva Ø 19 mm Obs.6 na cor preto (união) 32
F		Parafuso 3,5 x 14 cc 36
G		Parafuso 4,5 x 30 cc 18
H		Dobradiça can.35mm Supercurva 04
I		Suporte 13 x 13mm 04
J		Sapata 15 x 60mm 04
L		Cantoneira 3 furos 02
M		Parafuso 4,5 x 35 cc 02
N		Buchas 6 mm 02

Melhor forma da montagem de lado

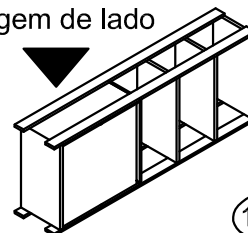
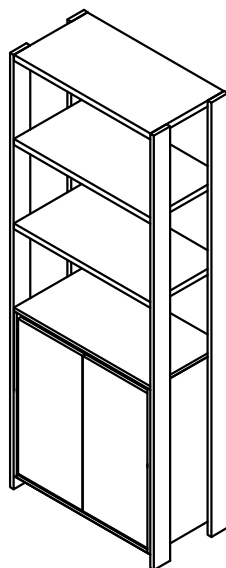

Ordem de montagem 1º Passo		
Nicho 2 portas		
1	14740	Base
2	14736	Lateral direita
3	14714	Coluna inferior
4	14715	Coluna superior
5	14741	Coluna traseira
6	14737	Lateral esquerda
7	14739	Fundo
8	14710	Tampo

Ordem de montagem 2º Passo		
1	14733	Lateral traseira esquerda
2	14735	Lateral frontal esquerda
3	14704	Tampos (3 x)
4	0000	Nicho montado
5	14732	Lateral traseira direita
6	14734	Lateral frontal direita
7	14742	Prateleira móvel
8	14738	Portas

