

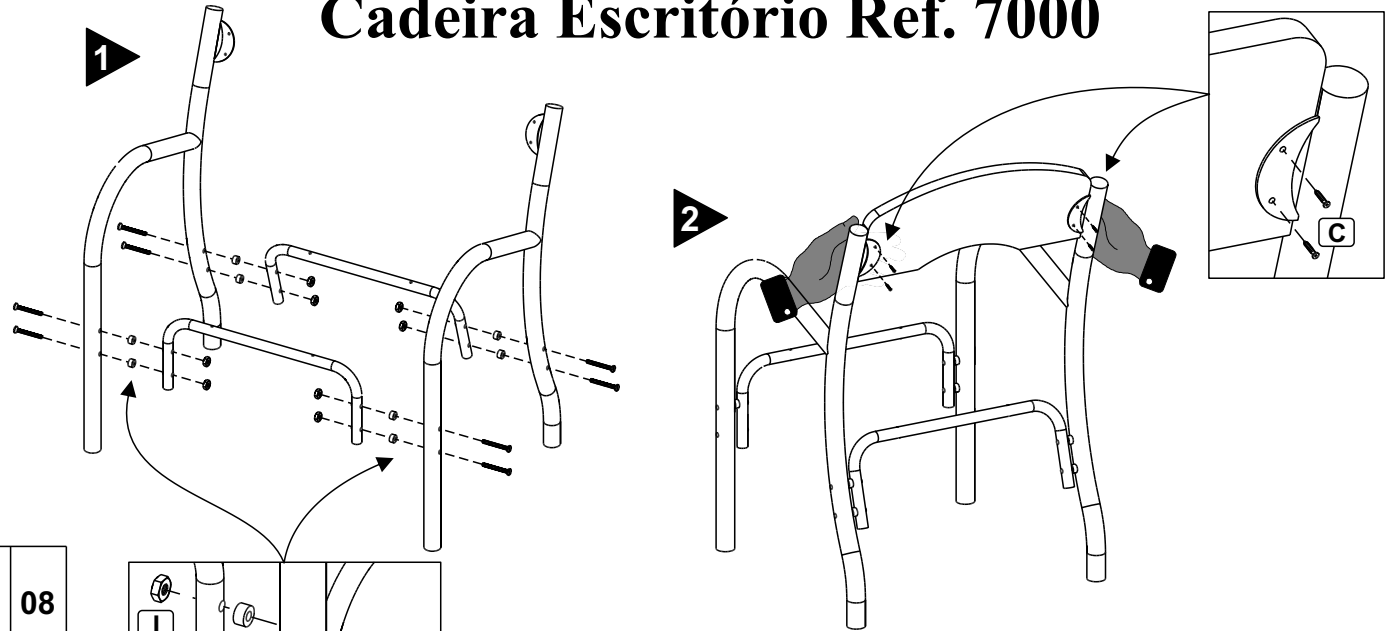

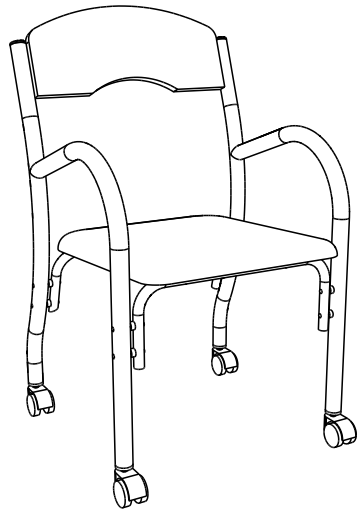







Cadeira Escritório Ref. 7000



A		08
B		04
C		04
D		08
E		02
F		04
G		04
H		04
I		08

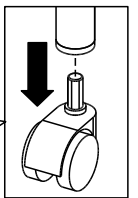
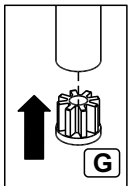
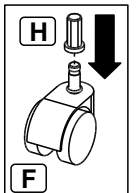
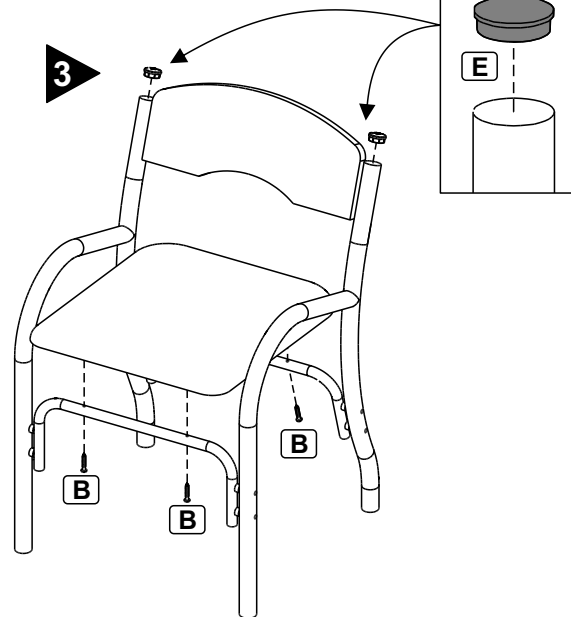
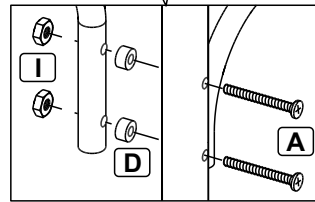

FIL MÓVEIS TUBULARES LTDA.

Rua: João Lorenzini, 33 - Bairro Universitário
Bento Gonçalves - RS - CEP 95700-000

Fone: (54) 3454-7280

e-mail: filmoveis@terra.com.br

