



MÓVEIS TUBULARES

BM MÓVEIS TUBULARES

Fone/Fax: 32 3578.1409

Rod. Guidoal / Ubá km 1,5 | Guidoal - MG

www.bmtubulares.com.br

bmtubulares@bmtubulares.com.br

Mesa BASE 1,40 (PARA MADEIRA)

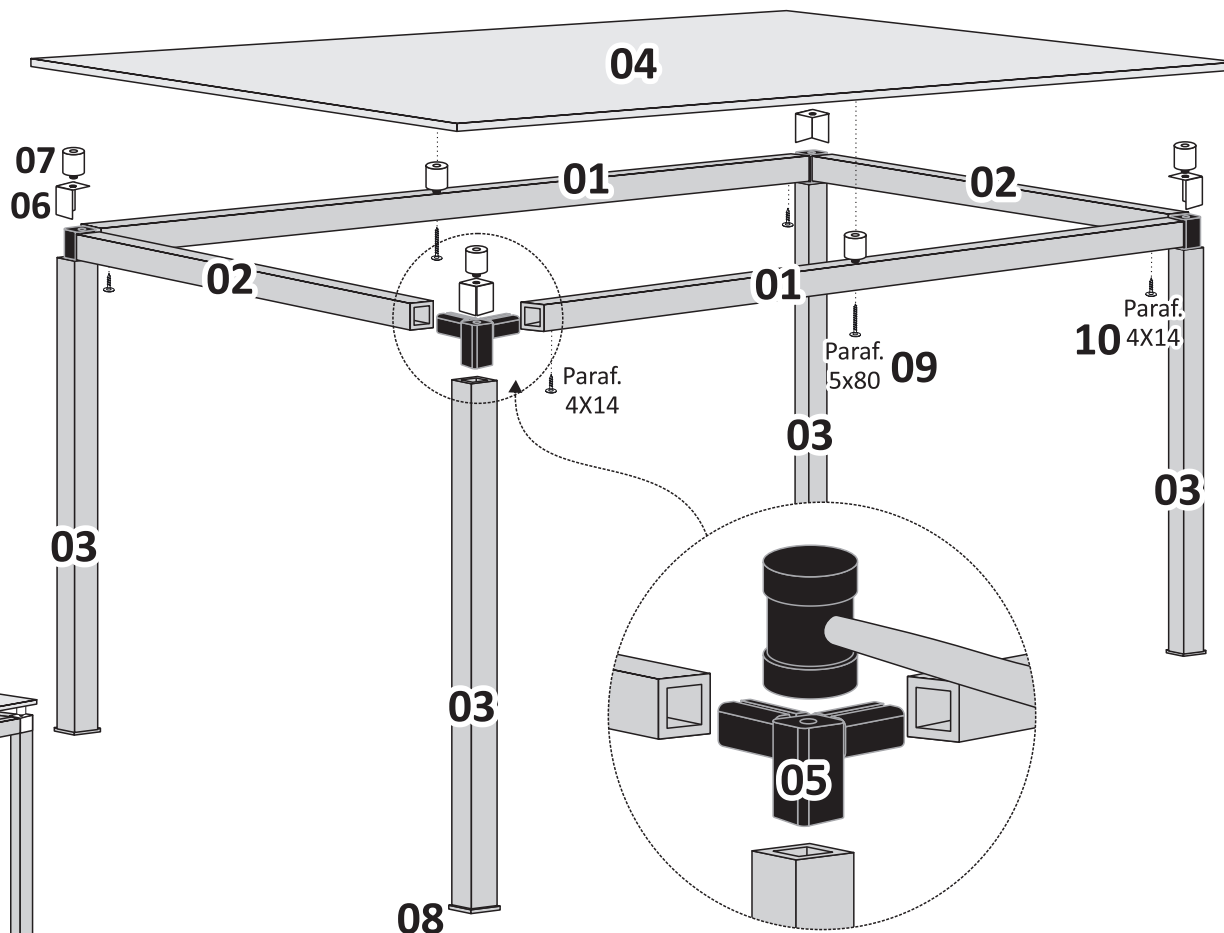
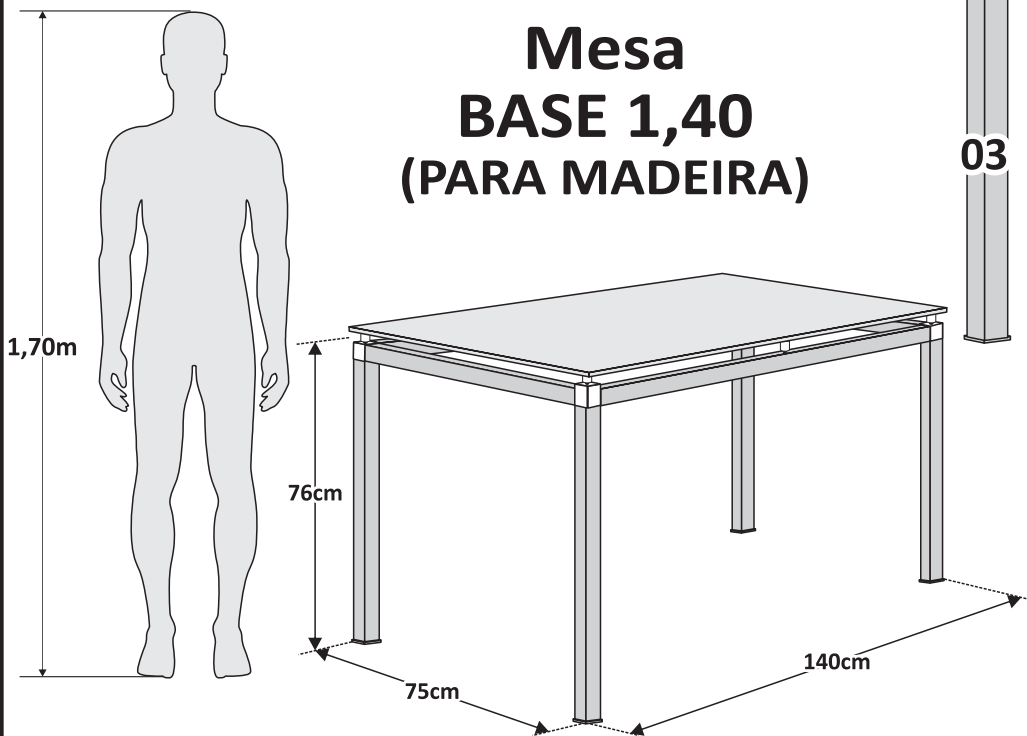

**ATENÇÃO: USAR MARTELO DE BORRACHA
PARA FIXAR A PEÇA 05**

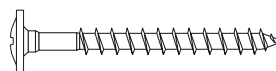

09 - Parafuso 5x80
Flangeado (02peças)

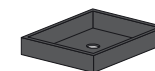

08 - Ponteira 40x40
Preta (04peças)

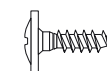

10 - Parafuso 4x14
(04peças)

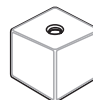

06 - Capa União
45x45 Cromada (04peças)

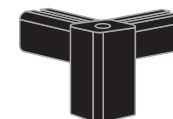

05 - Suporte Prótese
98x38x38mm Preta (04peças)



07 - Suporte p/ Vidro
c/ Ventosa 22X24 (06peças)

CÓD.	DESCRIÇÃO	UNID.	CLASSIFICAÇÃO	QUANT.
01	METALON 40x40 BARRA 132cm	UN	PEÇA	02
02	METALON 40x40 BARRA 66cm	UN	PEÇA	02
03	METALON 40x40 PÉ 66cm	UN	PEÇA	04
04	TAMPO 1,40x0,75m	UN	PEÇA	01