











ACESSÓRIOS

<p>A</p>  <p>Ø 5,0 x 50 mm 4x</p>	<p>B</p>  <p>Ø 5,0 x 40 mm 8x</p>	<p>C</p>  <p>Ø 3,5 x 14 mm 82x</p>	<p>D</p>  <p>Ø 5,5 x 65 mm 4x</p>
<p>E</p>  <p>Ø 8 x 30 mm 36x</p>	<p>F</p>  <p>12x</p>	<p>G</p>  <p>6x</p>	<p>H</p>  <p>Ø 10 x 10 mm 35x</p>
<p>I</p>  <p>200 mm 4x</p>	<p>J</p>  <p>350 mm 4x</p>	<p>K</p>  <p>645 mm 1x</p>	



NECESSÁRIO PARA MONTAGEM

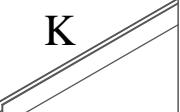
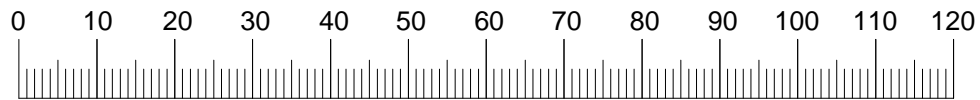
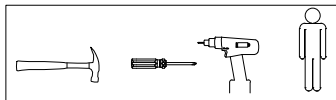

ROBEL - Ind. de Móveis Ltda.

AV. FELICIANO SALES CUNHA, 2999- JARDIM NOVO AEROPORTO

CEP 15035-000 SÃO JOSÉ DO RIO PRETO

FONE: +055 (17) 3203-0400 - FAX +055 (17) 3203- 0404

OBSERVAÇÕES IMPORTANTES

LIMPE COM UM PANO LIMPO E UMEDECIDO EM ÁGUA E SABÃO NEUTRO.

NÃO UTILIZAR PRODUTOS QUÍMICOS E ABRASIVOS

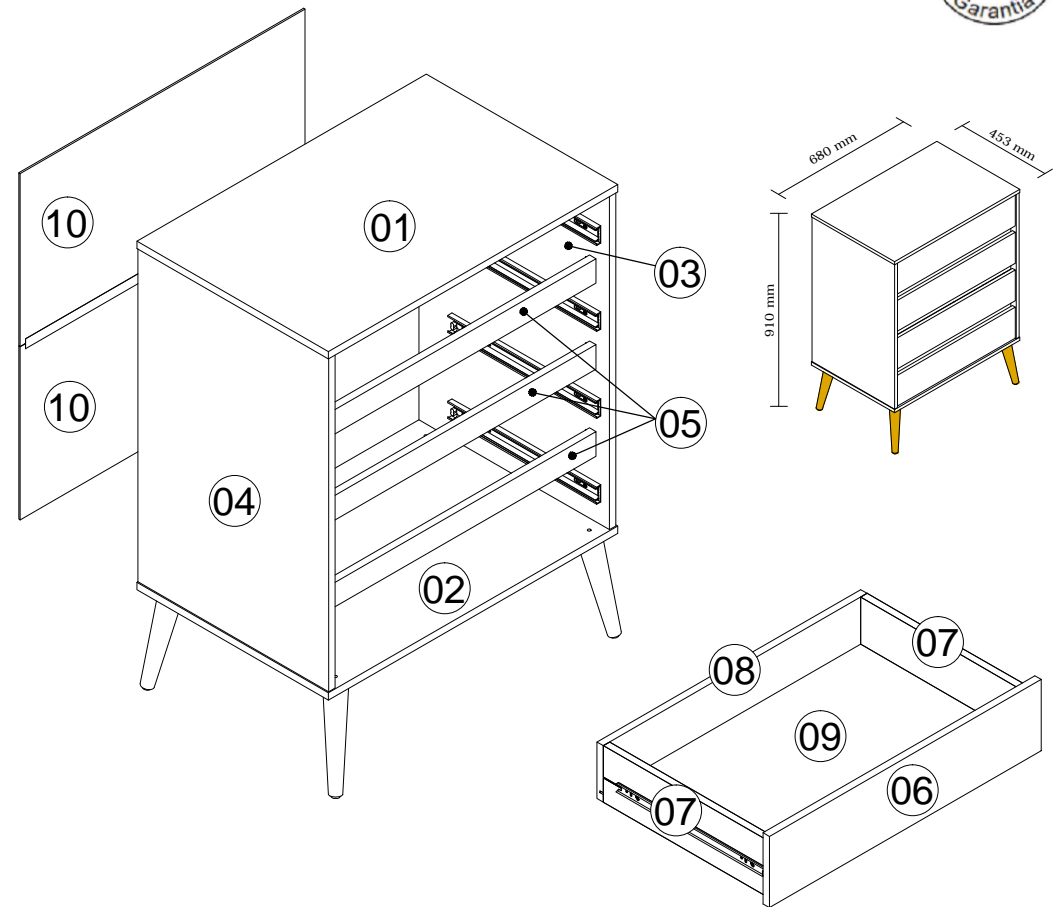

COD.	DESCRIÇÃO	QTD.
01	TAMPO	01
02	BASE	01
03	LATERAL DIREITA	01
04	LATERAL ESQUERDA	01
05	VISTA FRONTAL	03

COD.	DESCRIÇÃO	QTD.
06	FRENTE GAVETA	04
07	LATERAL GAVETA	08
08	CONTRA FUNDO	04
09	FUNDO GAVETA	04
10	FUNDO TRASEIRO	02

15.770 - CÔMODA 4 GAVETAS PÉ PALITO

FRENTE

