

ESTANTE

ESTANTE PORTO

 FITMOBEL

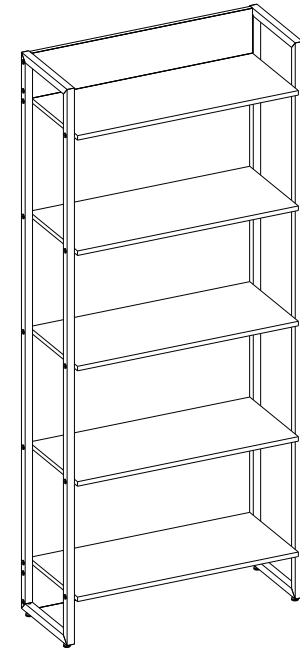
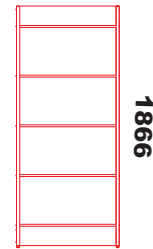

Parabéns pela aquisição de um produto de qualidade.
Em caso de dúvidas procure a loja em que efetuou a compra .
Congratulations on your purchase of a product of quality.
When in doubt look for the shop where you made the purchase.
Enhorabuena por la compra de un producto de calidad.
En caso de duda buscar la tienda donde hizo la compra.

Montador

Observe atentamente as instruções e siga rigorosamente as etapas de montagem.
Após a montagem entregue ao cliente para a garantia do produto

Assembler

Note the instructions carefully and strictly follow the assembly steps.
After assembly delivered to the customer for the product warranty

Ensamblador

tenga en cuenta las instrucciones cuidadosamente y seguir estrictamente los pasos de montaje.
Después del montaje entregado al cliente para la garantía del producto

Observações:

- Para limpeza utilize pano seco.
 - Não utilize álcool ou produtos químicos tipo limpeza pesada, bem como produtos abrasivos.
 - Pouca resistência à umidade.
 - 3 meses de garantia legal contra eventuais defeitos de fabricação .
- Não é coberto pela garantia. Danos referentes ao mal uso do produtos.

Resistência

-50Kg.

Comments:

- For cleaning only dry cloth.
- Do not use alcohol or heavy-duty cleaning chemicals as well as abrasive products.
- Low resistance to humidity

Warranty

- 3 months of legal warranty against any manufacturing defects.
It is not covered by warranty . Damages for the use of the product .

Resistance

-50kg

Observaciones:

- Para La limpieza paño seco.
- No utilice alcohol ni productos químicos como la limpieza pesada y productos abrasivos
- Poca resistencia a la humedad lo hará

Garantía

- 3 meses de garantía legal contra cualquier defecto de fabricación .
No está cubierto por la garantía . Los daños para el uso del producto.

Resistencia

-50kg

Montagem / Assembly / Montaje

Accessories / Acessórios / Accesorios

A Parafuso
AL INT SB 7,0x60
Screw
Tornillo

28 

B Chave allen 4,0
Allen key
llave allen

01 

C Capa parafuso
Screw cap
Cubierta de tornillo

28 

D Sapata
Shoes
Zapata

04 

E Bucha sapata
Shoe bushing
Buje de zapata

04 

Peças / Parts / Partes

01 Base

05

02 Painel frontal
Frontal View

02

03 Pé
Foot
Pie

02

Ferramentas / Tools / Herramientas

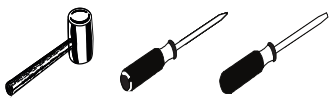

Instrução de montagem / assembly

*Antes de montar, confira todos os componentes e acessórios de acordo com a lista.
Forre o chão com papelão ou tecido.
Evite batidas nas peças ou entre elas para evitar riscos ou danos às estruturas.*

*Before mounting, check all components and accessories according to the list.
Paper or cardboard with the ground fabric.
Avoid tapping on the parts or between them to avoid scratches or damage to structures.*

*Antes del montaje, compruebe todos los componentes y accesorios de acuerdo a la lista.
Papel o cartón con el tejido de fondo.
Evitar tocar en las partes o entre ellos para evitar arañazos o daños a las estructuras.*

2^a

Utilizar a Chave Allen para fixação dos Parafusos no Pé ao painel
Use Allen wrench to secure Screws on Feet to panel with shoe
Utilizar la llave Allen para fijar los Tornillos en el Pies al panelbucha zapato

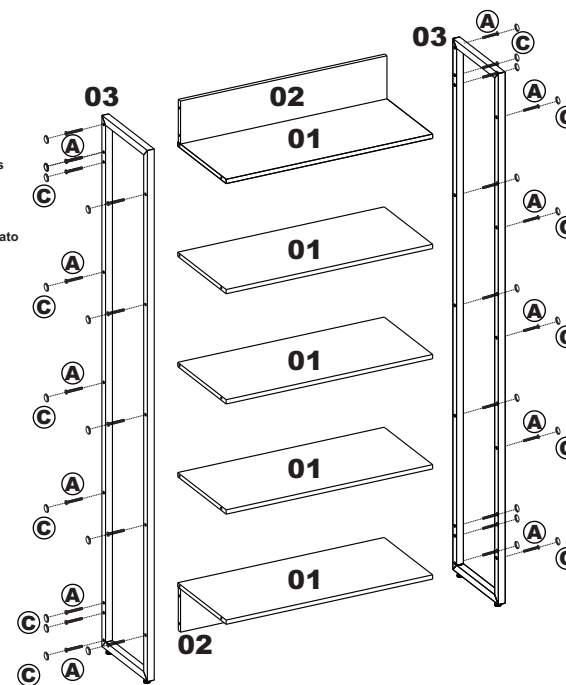

1^a

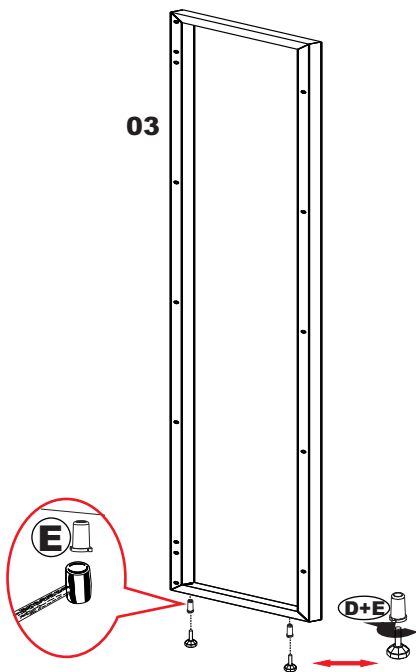

3^a

