

CM-8008

Instruções de Montagem Assembly Instructions Instrucciones de Armado

Acces Vdeos de Montagens
Access Mounting Videos
Acceder a los Vdeos de Montaje
www.tecnomobili.ind.br

tecnomobili

Estrada RSC 453, Km s/n° | Garibaldi | RS
CEP: 95720-000 | Fone / Fax: 54.3464.2050
sac@moveisvideira.com.br

Lista de Peças / List of pieces / Lista de piezas

Cód	DESCRIÇÃO	DESCRIPTION	DESCRIPCION	QTD	RAW MATERIAL	DIMENSION	CÓD
01	Lateral Inferior	Lower Side	Lateral Inferior	2	MDP15mm	900x92x15mm	308003
02	Frente	Front	Frente	1	MDP15mm	1886x224x15mm	98001
03	Costa	Back	Revés	1	MDP15mm	1886x92x15mm	408001
04	Suporte Lastro	Ballast Support	Soporte Lastre	4	Madeira	900x40x22mm	9697
05	Lastro	Ballast	Lastre	12	Madeira	900x50x10mm	9655

Notas Especiais:

- 01** -Examine completamente todas as peças do móvel antes de começar o trabalho.
02 -Recomenda-se montar o móvel conforme este Manual de Montagem.
03 -É de responsabilidade do montador seguir as instruções do Manual de Montagem, que são fundamentais para garantir a estrutura do móvel.
04 -Para limpeza, utilizar somente pano úmido e sabão neutro.

Special notes:

- 01** -Check all parts of the unit thoroughly before starting work.
02 -It is recommended to assemble the furniture according to this Installation Manual.
03 -It is the responsibility of the assembler to follow the instructions in the Assembly Manual, which are essential to ensure the structure of the furniture.
04 -For cleaning use only damp cloth and neutral soap.

Notas especiales:





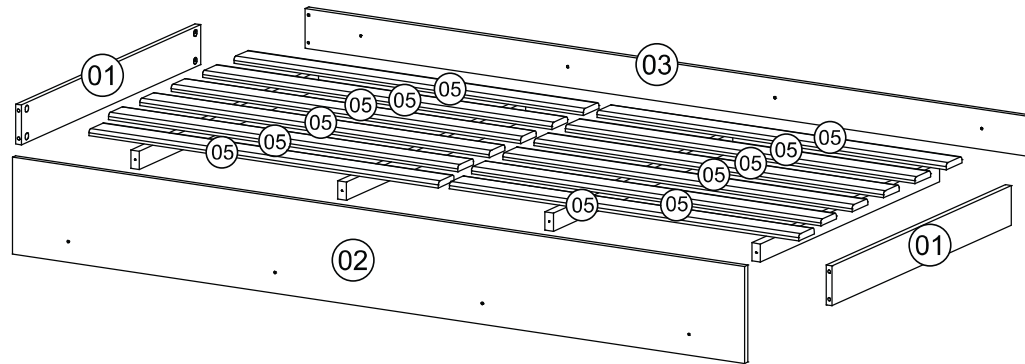

- 01** -Examine completamente todas las piezas del mueble antes de iniciar el trabajo.
02 -Se recomienda montar el mueble conforme el Manual de Ensamblaje.
03 -Es de responsabilidad del montador seguir las instrucciones del Manual de Ensamblaje, que son fundamentales para garantizar la estructura del mueble.
04 -Para limpieza solamente usar trapo húmedo y jabón neutro.

Garante certificate:

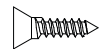
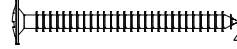
The guarantee of products manufactured by Móveis Videira LTDA covers any defects / manufacturing defects, within the period established by the Consumer Protection Code, in its Article 26, II, which provides for a legal guarantee of ninety (90) days.



LUSTRAÇÃO - ILUSTRACION - ILLUSTRATION

REF	DESCRIÇÃO	QTD
A	 3,5 x 14mm CC	08 3639
B	 4,0 x 50mm CF	08 2070
C	 15 x 12mm Tambor Minifix	08 9516
D	 22 x 3mm Prego 10x10	24 3639
E	 34 x 7mm Parafuso Minifix	08 3771
F	 Rodizio RB 30	04
G	 Tapa Furo	04

Ferramentas | Tools | Herramientas

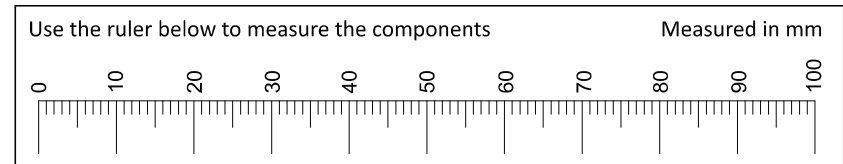
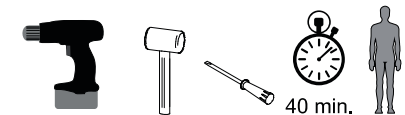

Revisão: 01
Data: 26/01/2023

