

Instruções de Montagem

Instrucciones de Montage

Assembly Instructions

REF.

HO-2907

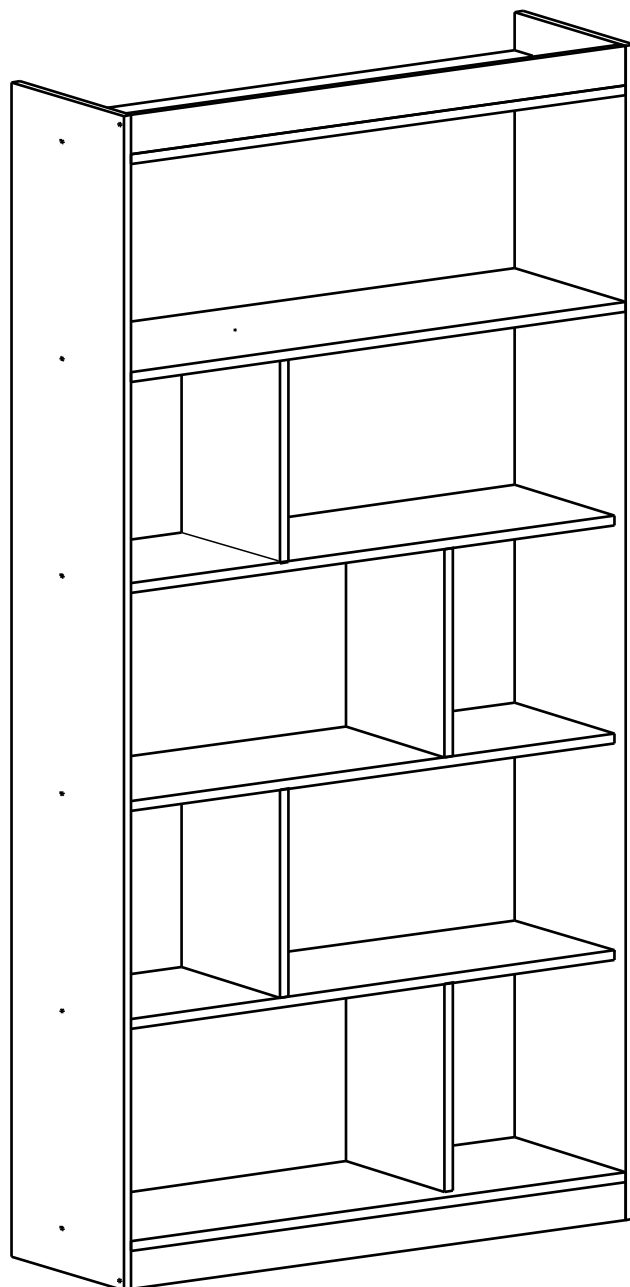

HECOL

móveis

Rua Arlindo Baccin, 601 - Lot. Vinhedos,
Bento Gonçalves, RS - CEP: 95707-150

Fone: (54) 3454-5900

Email: contato@hecolmoveis.com.br

Site: www.hecolmoveis.com.br

LISTA DE PEÇAS

Nº PEÇA	CÓD. IND.	DESCRIÇÃO	QTD.	COMP. (mm)	LARG. (mm)	ESP. (mm)
01		Lateral	2	1810	300	MDP 15
02		Base Maior Mod 1	1	900	300	MDP 15
03		Base Maior Mod 2	2	900	300	MDP 15
04		Base Menor Mod 1	2	900	268	MDP 15
05		Base Menor Mod 2	1	900	268	MDP 15
06		Rodapé/Rodaforro	2	900	60	MDP 15
07		Divisão	4	320	268	MDP 15
08		Costa	5	926	335	HDF 3

LISTA DE PEÇAS

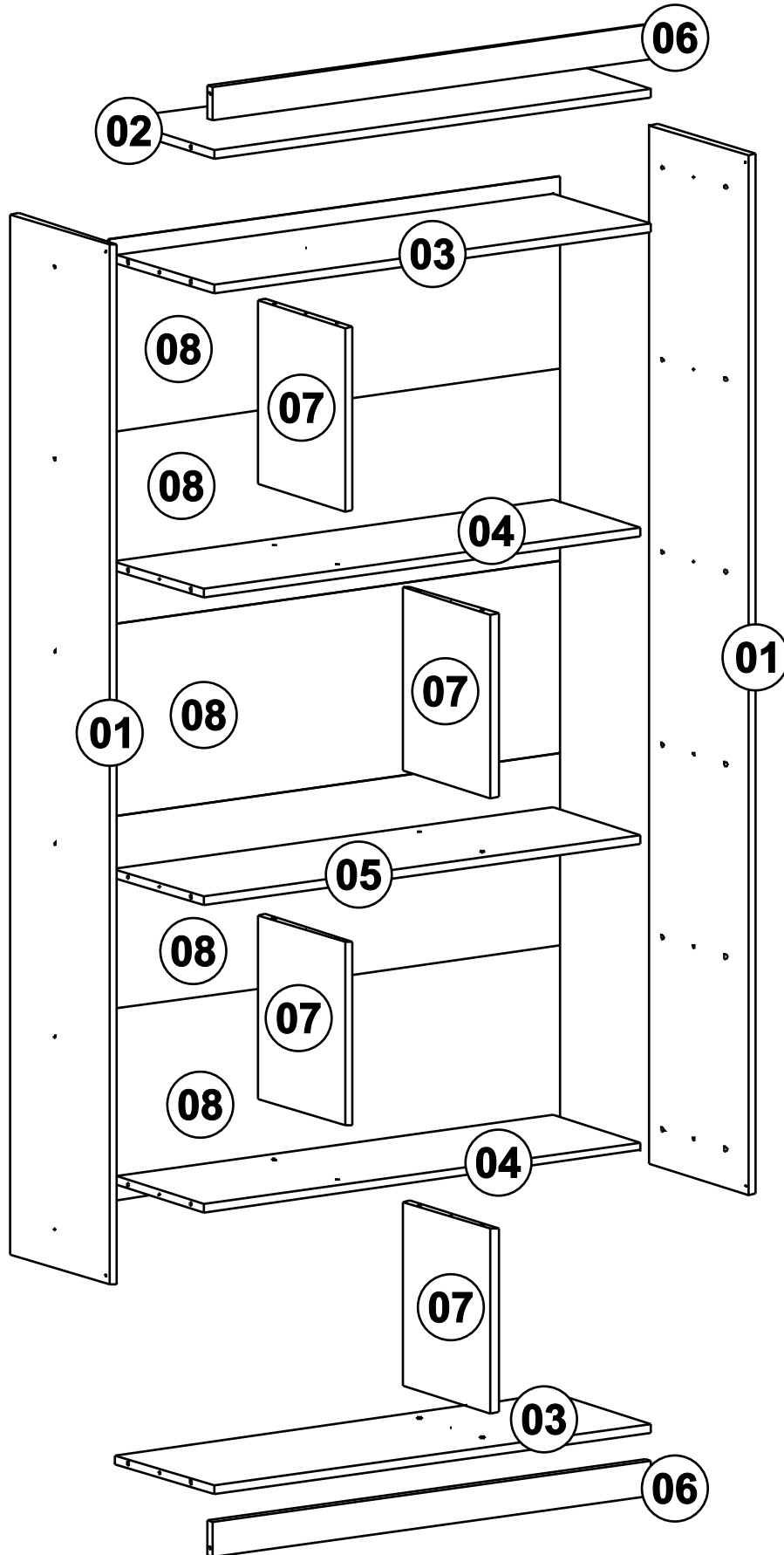





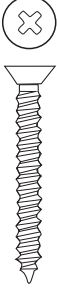

VERSÃO:
02

DATA:
23/10/23

ELABORADO POR:
Michel

LISTA DE FERRAGEM

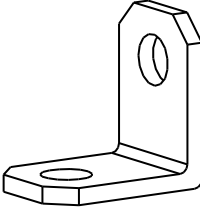
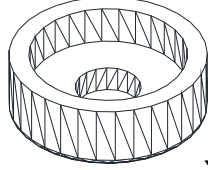
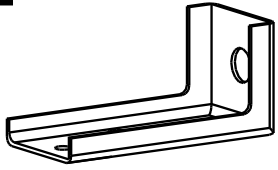
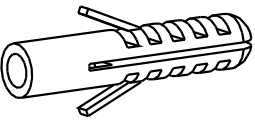
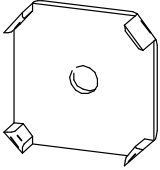
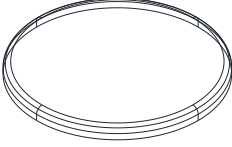
<p>A</p>  <p>x18</p> <p>Parafuso 4,5x50mm CC</p>	<p>B</p>  <p>x02</p> <p>Parafuso 5x40mm CF</p>	<p>C</p>  <p>x10</p> <p>Parafuso 3,5x14mm CP</p>	<p>D</p>  <p>x40</p> <p>Cavilha 8x30mm</p>
<p>E</p>  <p>x06</p> <p>Prego 12x12</p>	<p>F</p>  <p>x72</p> <p>Prego 10x10</p>	<p>G</p>  <p>x02</p> <p>Chapa "L" 20x20x12mm</p>	<p>H</p>  <p>x06</p> <p>Sapata</p>
<p>I</p>  <p>x02</p> <p>Suporte Aéreo Reforçado</p>	<p>J</p>  <p>x02</p> <p>Bucha 6x35mm</p>	<p>K</p>  <p>x20</p> <p>Garra Costa</p>	<p>L</p>  <p>x17</p> <p>Tapa Furo PVC</p>

Para a montagem do produto você vai precisar de:

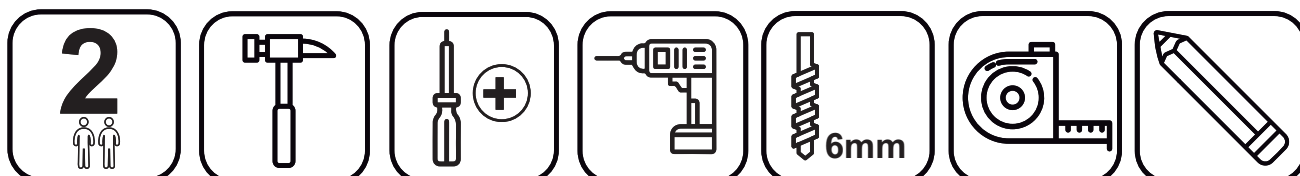

01

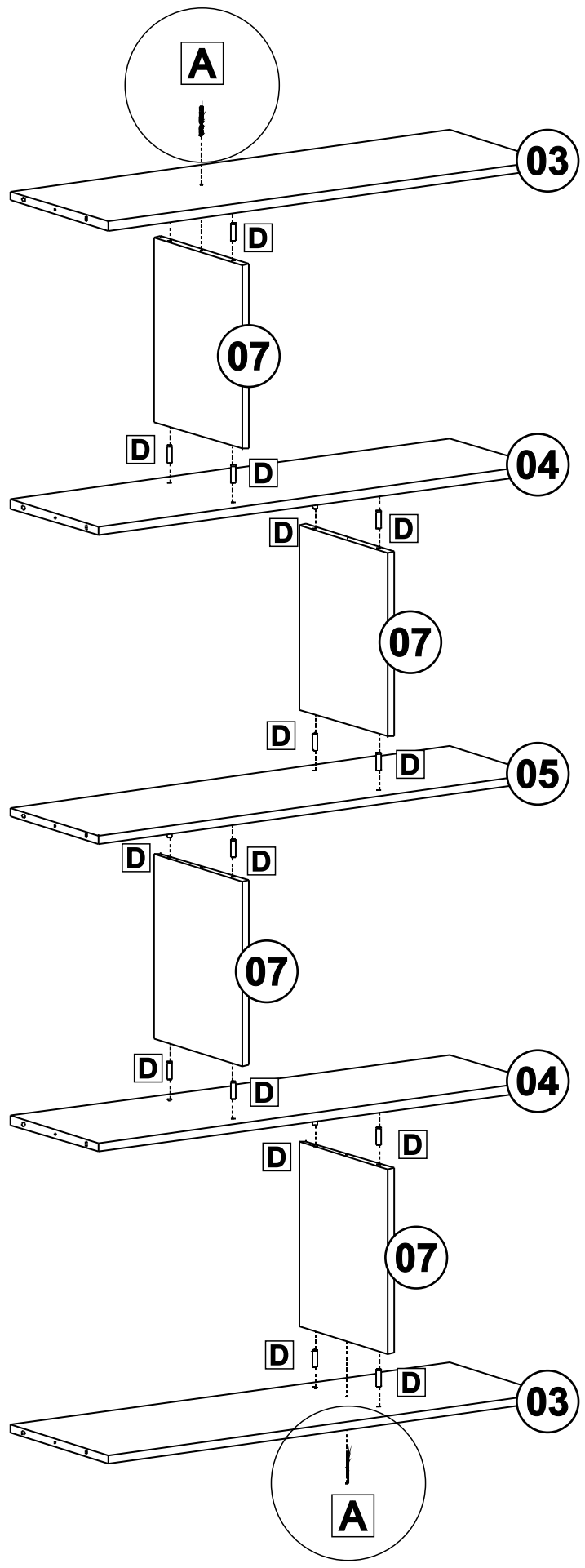

02

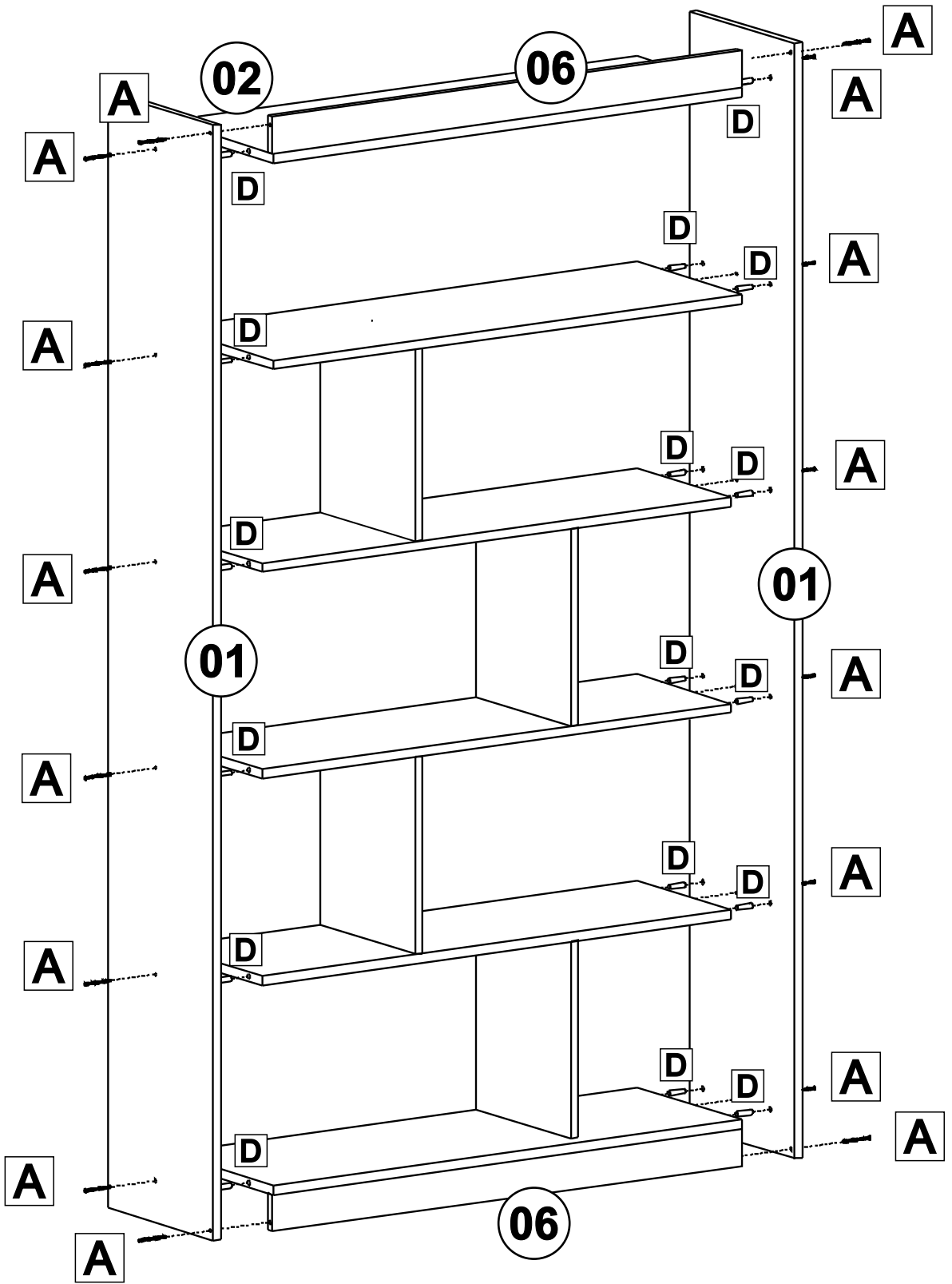

03

Fixar as peças 08 com o item F.

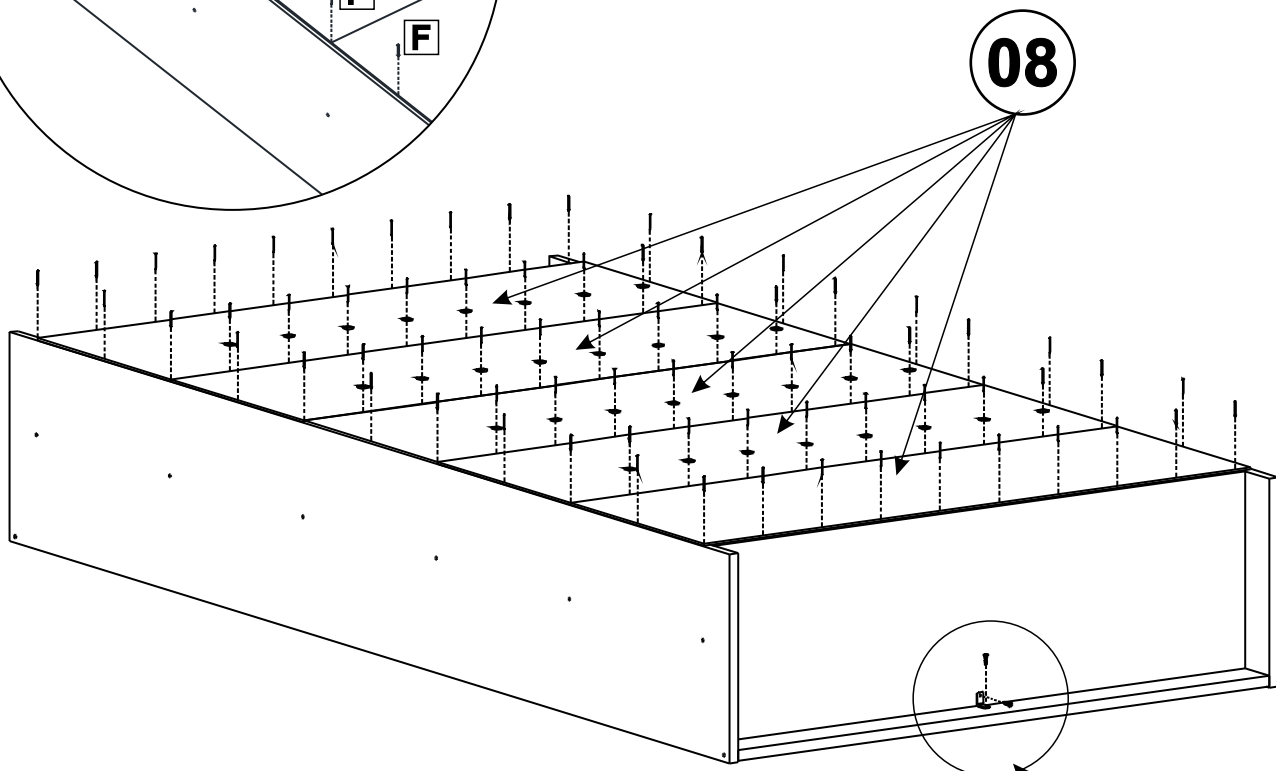
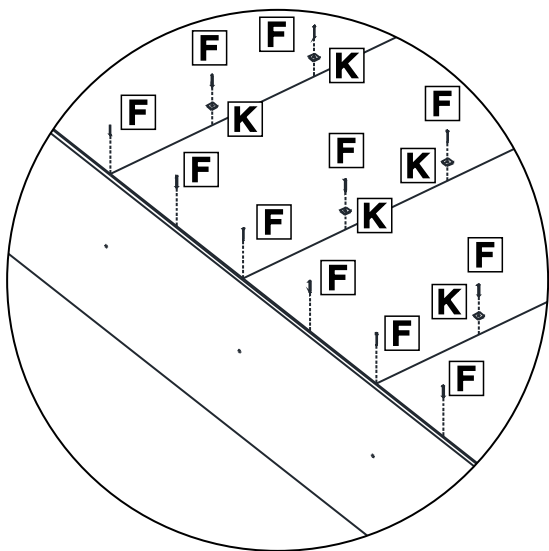

Fixação interna do Rodapé e Rodaforro.

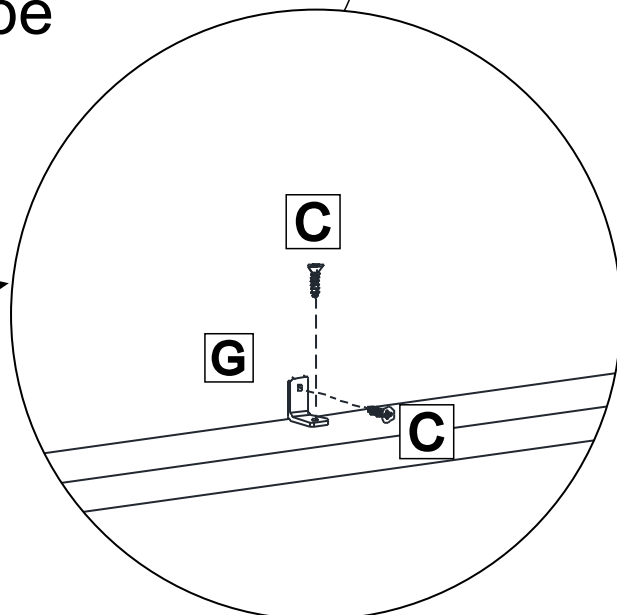

04

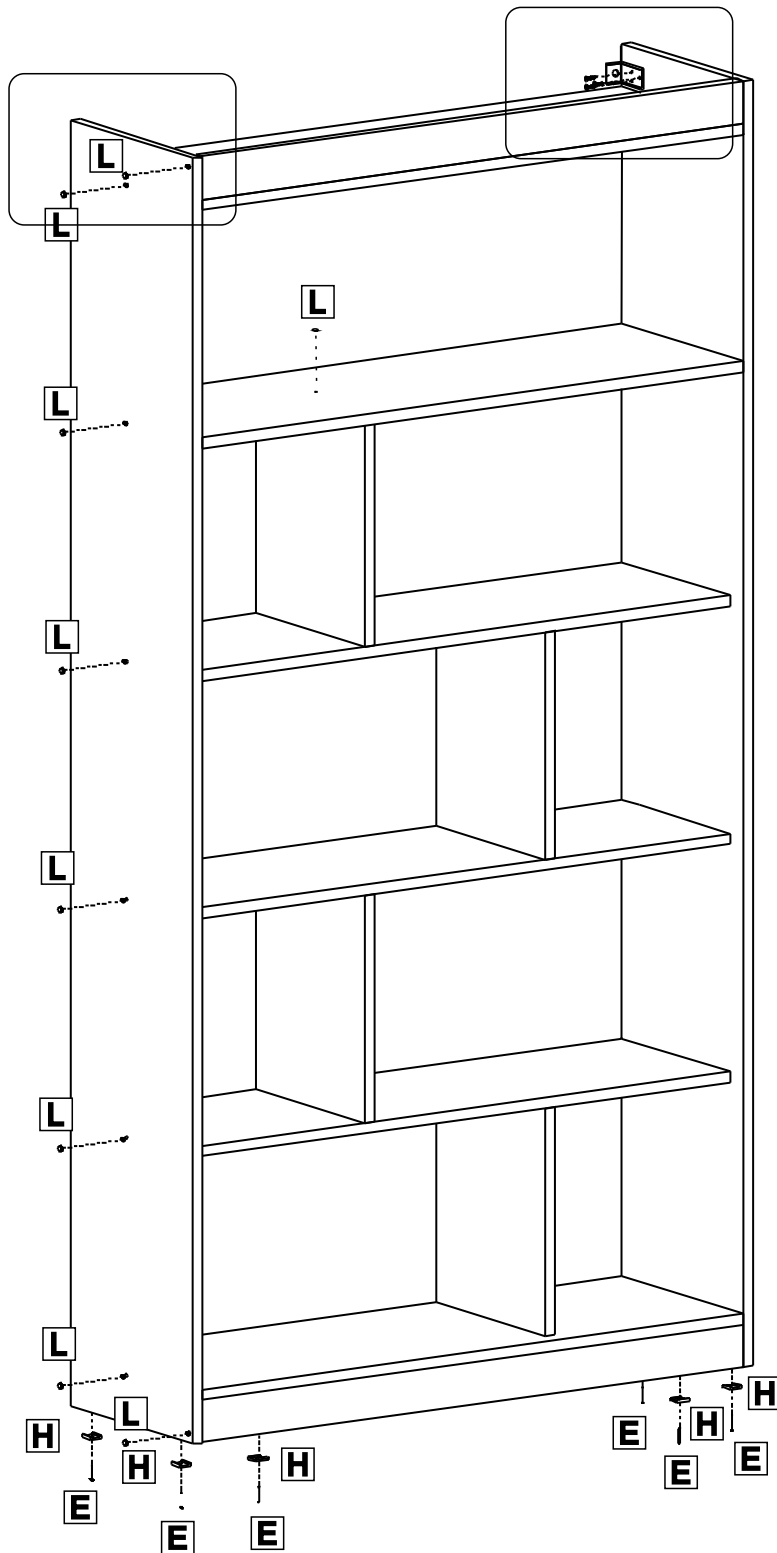

FIXAR O MÓVEL NA PAREDE

