

# CO8220 - PANELEIRO DUPLO 0,70 M

Manual de Montagem  
Assembly Instructions  
Instrucción de Montaje

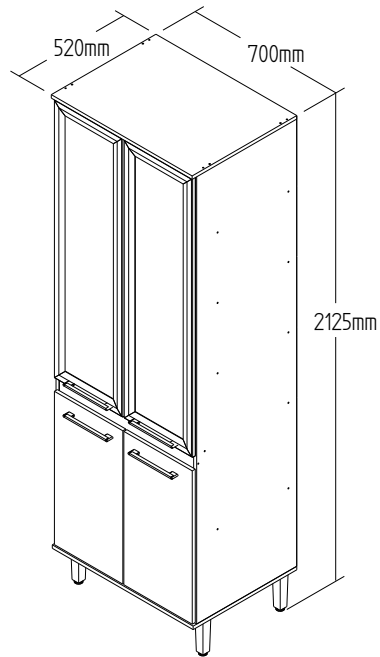

Produto Montado  
Producto final  
Assembled



01°

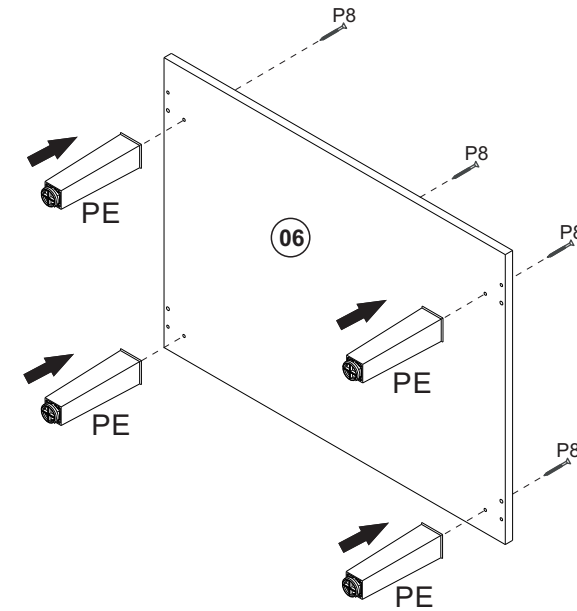

02°

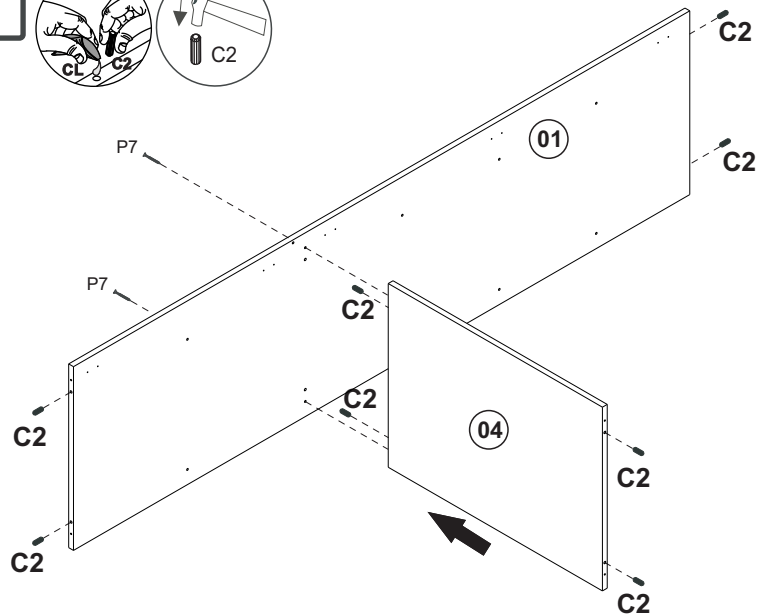
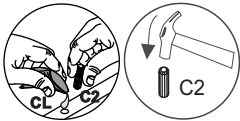

03°

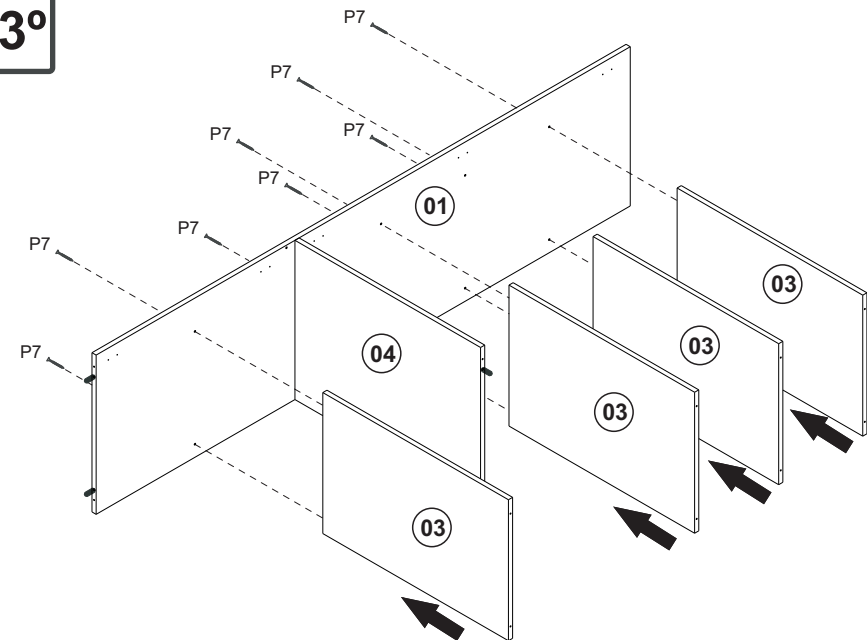

# CO8220 - PANELEIRO DUPLO 0,70 M

Manual de Montagem  
Assembly Instructions  
Instrucción de Montaje



04°

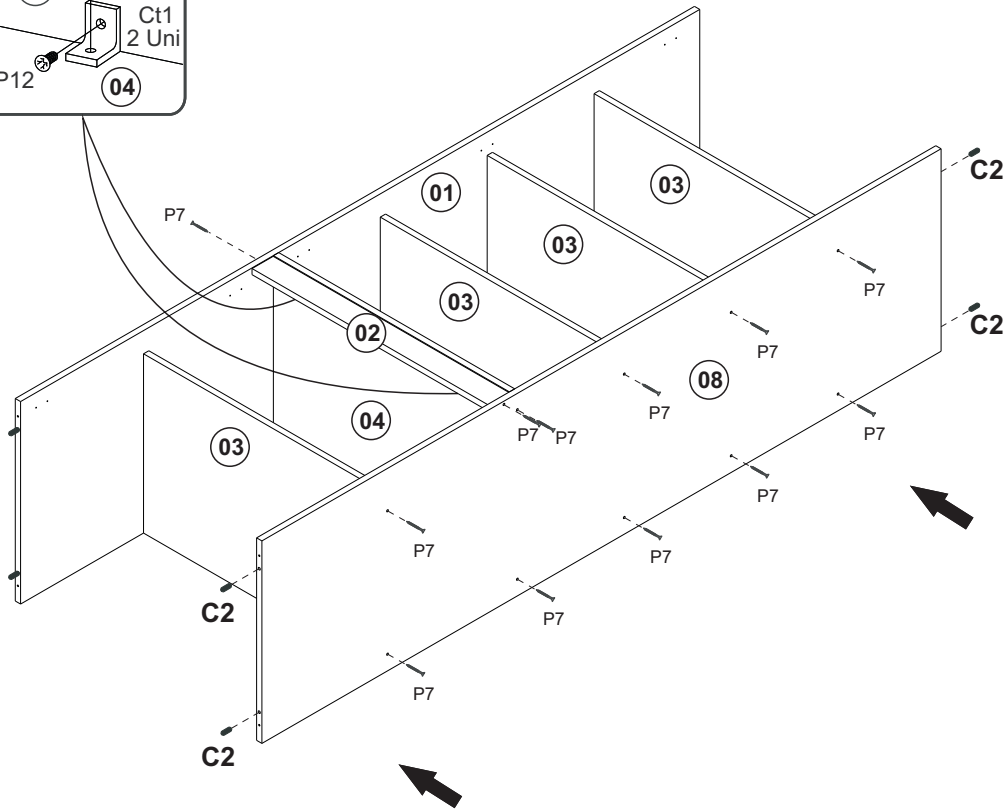
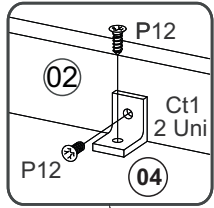
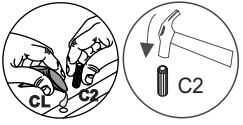

05°

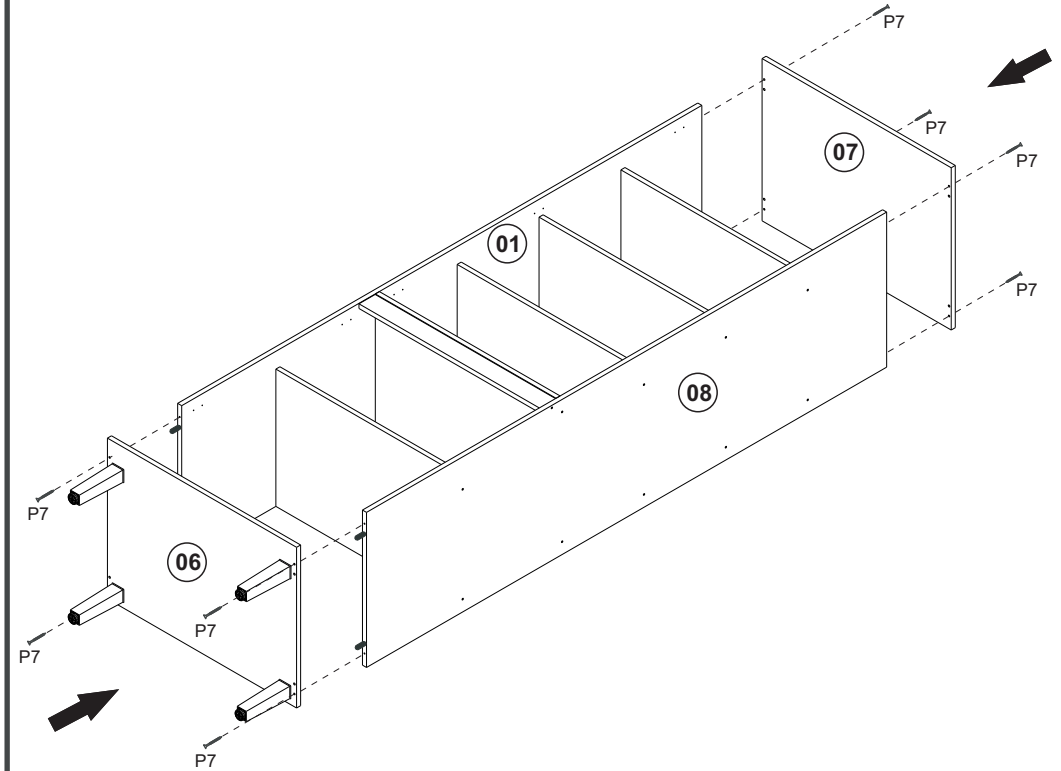
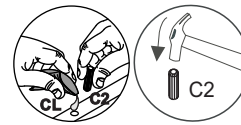

# CO8220 - PANELEIRO DUPLO 0,70 M

Manual de Montagem  
Assembly Instructions  
Instrucción de Montaje



06°

COSTA/REVÉS/BACK

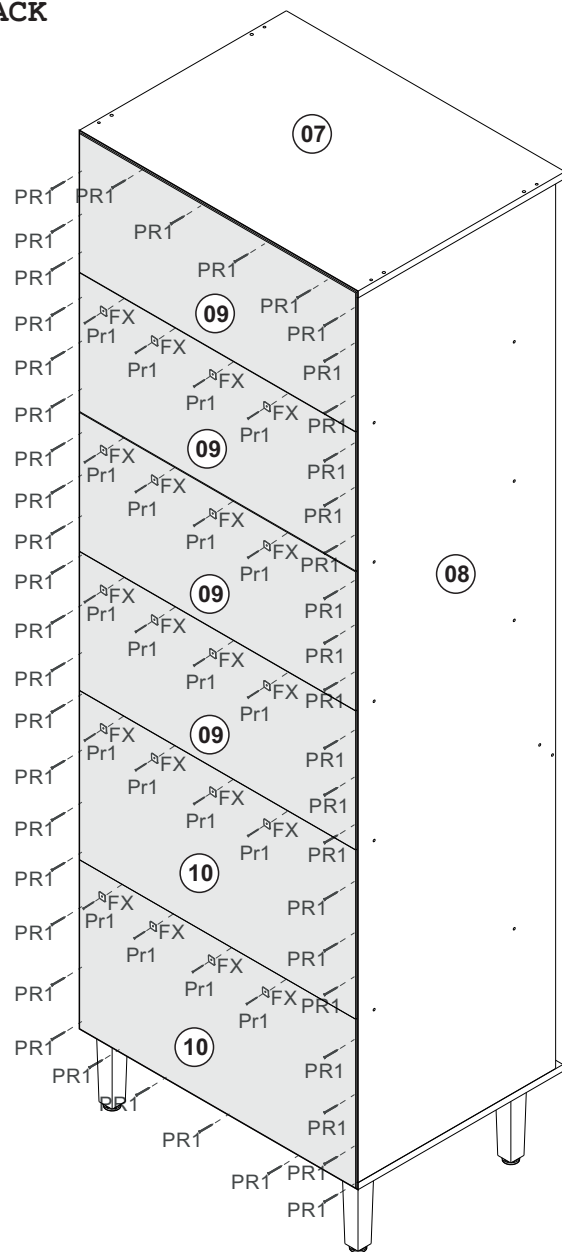
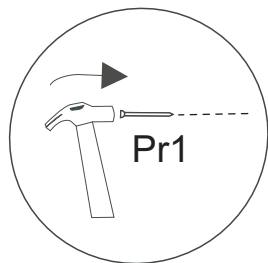

07°

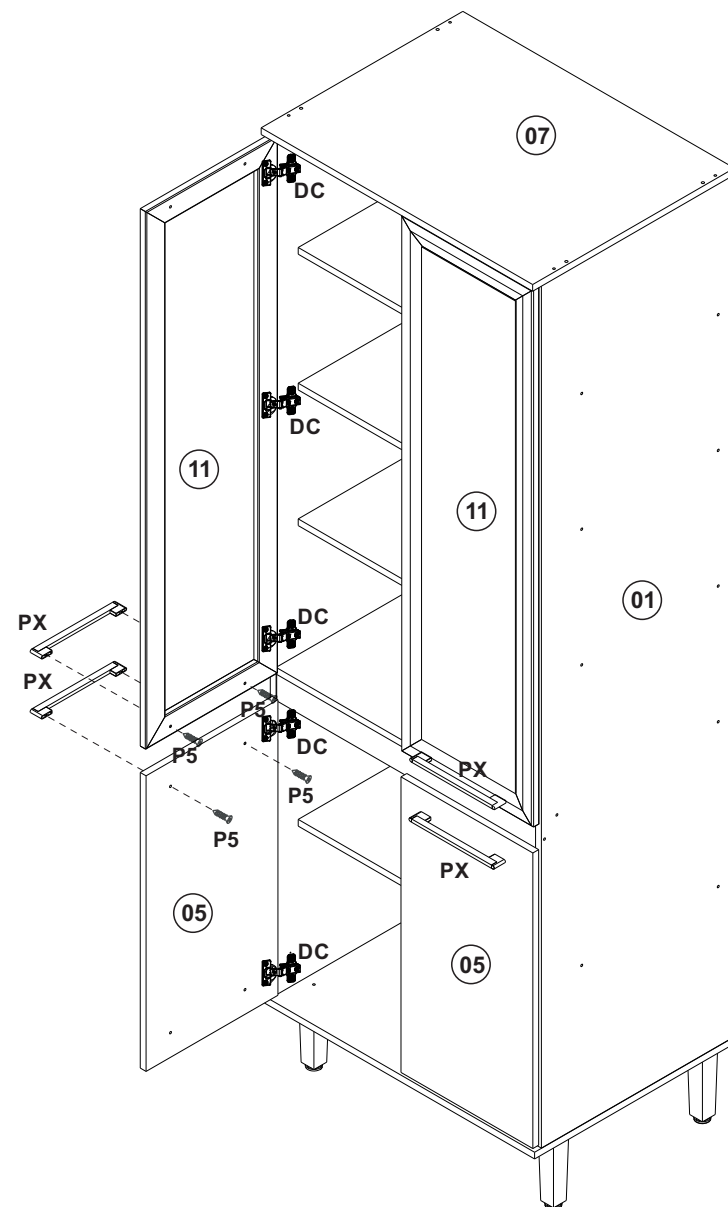
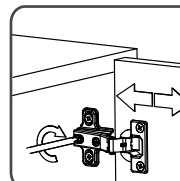
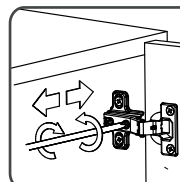
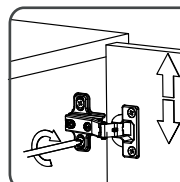
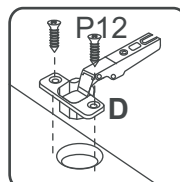
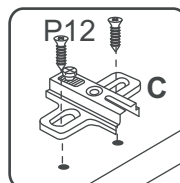

# CO8220 - PANELEIRO DUPL0 0,70 M

Manual de Montagem  
Assembly Instructions  
Instrucción de Montaje

**decibal**<sup>®</sup>  
móveis

08°

PESO SUPORTADO/PESO SOPORTADO/WEIGHT SUPPORTED

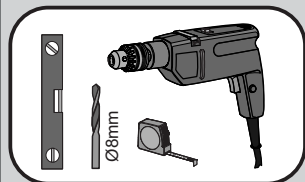

Fixação parede  
Fixed in the wall

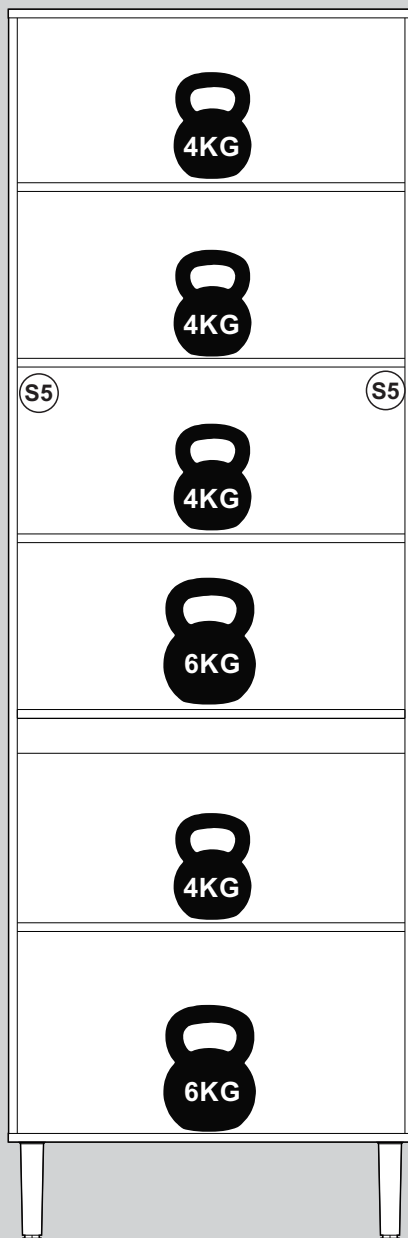
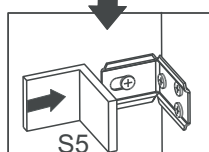
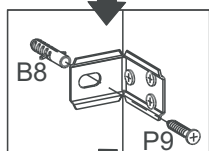
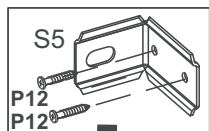

## Relação de Peças/ Relación de Piezas/Parts List

N°	CÓDIGO/CODE	DESCRIÇÃO/DESCRIPCIÓN/DESCRIPTION	QTD/CANT	VOL.
1	0549100	LATERAL DIR/LATERAL/SIDE 1925X497X15MM	1,00	1
2	0549103	TRAVESSA FRT 669X60X15MM	1,00	1
3	0549104	PRATELEIRA MENOR/ESTANTE/SHELF 669X420X15MM	4,00	1
4	0549208	BASE MEIO 669X497X15MM	1,00	1
5	0549105	PORTA/PUERTA/DOOR 660X340X15MM	2,00	1
6	0549099	BASE 700X515X15MM	1,00	1
7	0549102	TAMPO/TAPA/TOP 700X520X15MM	1,00	1
8	0549101	LATERAL ESQ/LATERAL/SIDE 694X302X2,8MM	4,00	1
9	0549107	COSTA MENOR/REVÉS/BACK 1925X497X15MM	2,00	1
10	0549106	COSTA MAIOR/REVÉS/BACK 694X302X2,8MM	2,00	1
11	11934	PORTA VIDRO/PUERTA/DOOR 1200X340X18MM	2,00	2

[www.decibal.com.br](http://www.decibal.com.br)

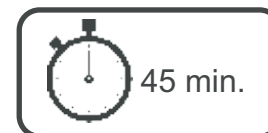

**ATENÇÃO!!!!** montadores e consumidores  
\* Ajustar o torque da parafusadeira para não danificar as peças escareando o parafuso \*  
**ATENCIÓN!!!!** montadores e consumidores  
\* Ajuste el torque del destornillador para no dañar las piezas avallando el tornillo \*  
**ATTENTION!!!!** assemblers and consumers  
\* Adjust the torque of the screwdriver so as not to damage the parts by countersinking the screw \*

Ferramenta necessárias  
Necessary tools  
Herramientas necesarias



**ATENÇÃO!!!!** montadores e consumidores  
\* Para limpar o móveis utilize somente um pano úmido (umedecido em água pura ou água com sabão neutro). Depois, passe um pano seco. Evite a umidade excessiva.  
\* Evite usar álcool, água sanitária, detergente e outros produtos químicos, mesmo diluídos em água. Não utilize produtos abrasivos de nenhuma espécie

**ATENCIÓN!!!!** montadores e consumidores  
\* Para limpiar el mueble utilice solamente un paño húmedo (humedecido con agua limpia o con un jabón suave). A continuación, utilice un paño seco. Evite el exceso de humedad.  
\* Evite uso de alcohol, hipoclorídoro solución basada, detergente y otros productos químicos, mismo diluídos en agua. No utilice productos abrasivos de ningún tipo.  
**ATTENTION!!!!** assemblers and consumers  
\* To clean the furniture, use only a damp cloth (humidify it only in pure water ou water and neutral soap). After, use a dry cloth. Avoid excessive humidity.  
\* Avoid using alcohol, bleach, detergent and other chemical products, even diluted in water. Do not use any kind of abrasive cleaning agents to clean the furniture.  
The use of such products may jeopardize the final characteristics of the furniture.

# CO8220 - PANELEIRO DUPL0 0,70 M









Manual de Montagem  
Assembly Instructions  
Instrucción de Montaje











## Ferragens/ Herrajes/ Hardware

escala (1:1)

escala (N/A)

LEGENDA	DESCRIÇÃO/DESCRIPCIÓN/DESCRIPTION	CÓDIGO	QUANT.
<b>P7</b>	 PARAFUSO/TORNILLO/SCREW 4X45	01318	<b>30</b>
<b>PR1</b>	 PREGO/CLAVO/NAIL 10X10	01330	<b>95</b>
<b>C2</b>	 CAVILHA/TARUGO/DOWEL 6X30 MM	01211	<b>13</b>
<b>P8</b>	 PARAFUSO/TORNILLO/SCREW 5X45	01320	<b>04</b>
<b>PU</b>	 PARAFUSO UNIÃO/UNIÓN DETORNILLO /SCREW UNION	01495	<b>02</b>
<b>P5</b>	 PARAFUSO/TORNILLO/SCRE3,5X25	09955	<b>08</b>
<b>P12</b>	 PARAFUSO/TORNILLO/SCREW 3,5X13	09927	<b>48</b>
<b>P9</b>	 PARAFUSO/TORNILLO/SCREW 6X50	03827	<b>02</b>

LEGENDA	DESCRIÇÃO/DESCRIPCIÓN/DESCRIPTION	CÓDIGO	QUANT.
<b>CL</b>	 COLA/PEGAMENTO/GLUE	01213	<b>01</b>
<b>ET</b>	 ETIQUETA LOGO DECIBAL/LABEL DECIBAL	01312	<b>01</b>
<b>B8</b>	 BUCHA/BUJE/BUCHING 8mm	01311	<b>02</b>
<b>Ct1</b>	 CANTONEIRA/PIEZA L/SHEET	03077	<b>02</b>
<b>DC</b>	 DOBRADIÇA/BISAGRA/HINGE D=35mm C=0mm	09449	<b>10</b>
<b>S5</b>	 SUPORTE AÉREO/APOYO AÉREO/AIR SUPPORT	03828 Wood 09647	<b>02</b>
<b>Fx</b>	 FIXADOR COSTA/FIJADOR FONDO/FIXER COAST	01331	<b>25</b>
<b>PX</b>	 PUXADOR/ PEGADOR/ HANDLE	11020	<b>04</b>
<b>AD</b>	 ADESIVO/ADHESIVO/ADHESIVE 15mm	Wood 09929 Naturalle 09963	<b>24</b>

Medida em mm

