

CO8201 - AÉREO 0,60 M

Manual de Montagem
Assembly Instructions
Instrucción de Montaje

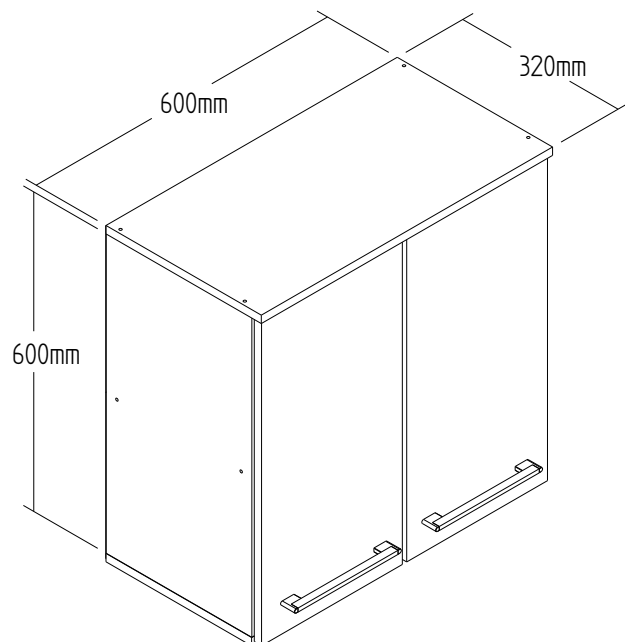

Produto Montado
Producto final
Assembled



1°

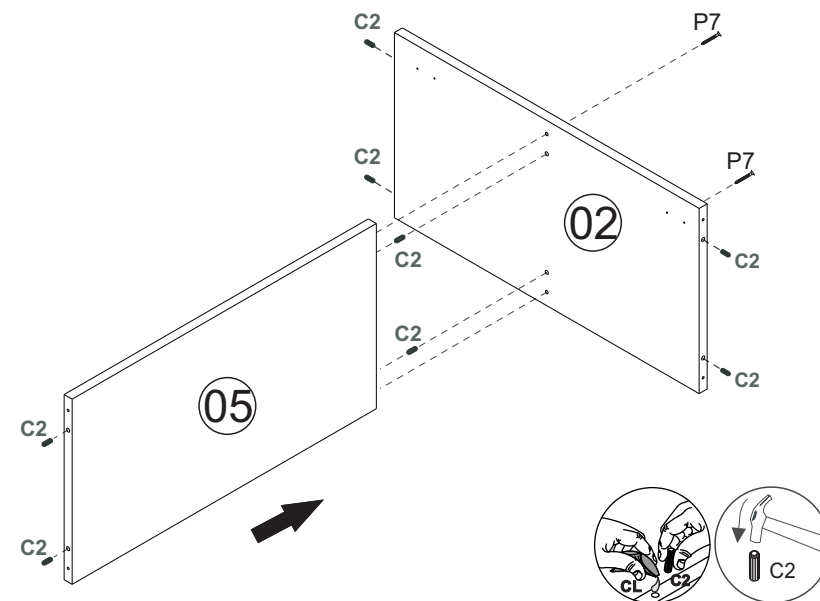

2°

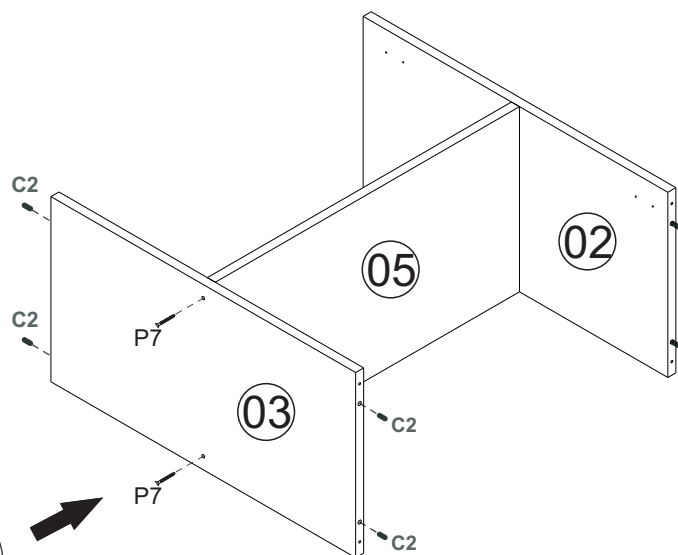

3°

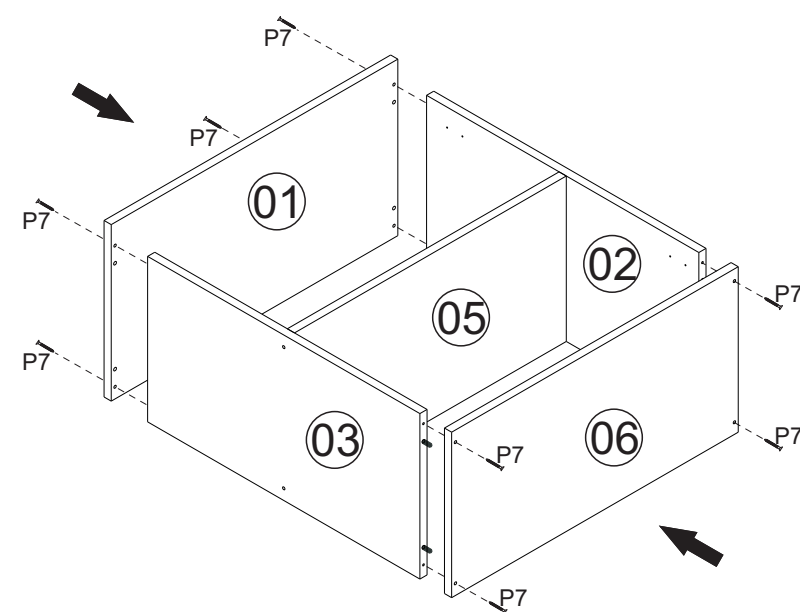

CO8201 - AÉREO 0,60 M

Manual de Montagem
Assembly Instructions
Instrucción de Montaje



4°

COSTA/REVÉS/BACK

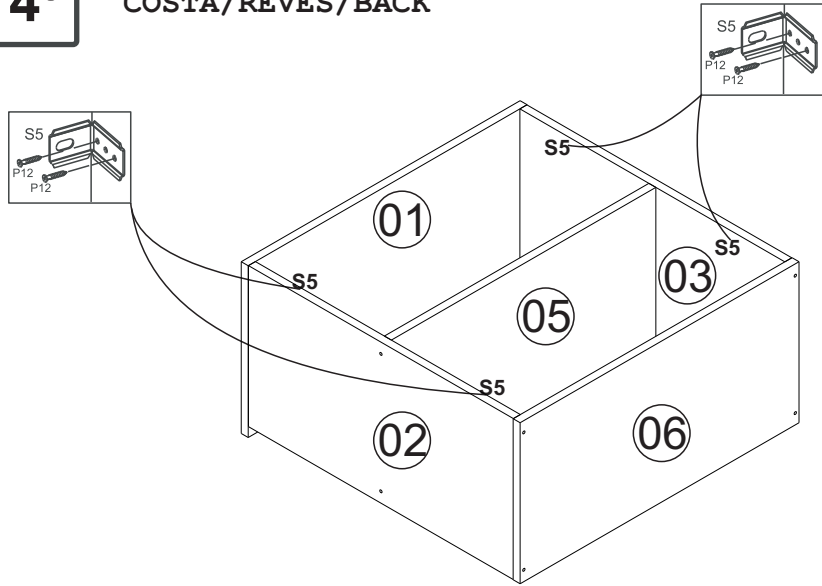

6°

Fixação parede
Fixed in the wall

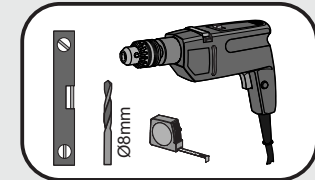
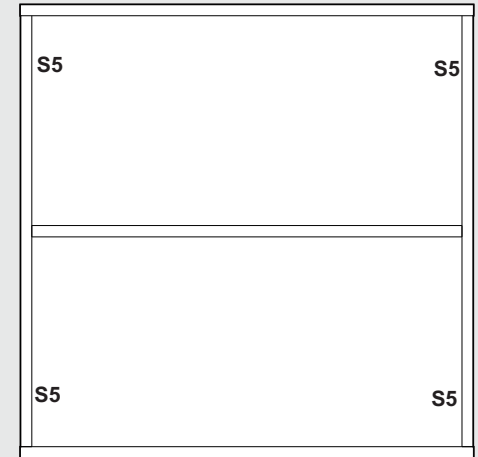
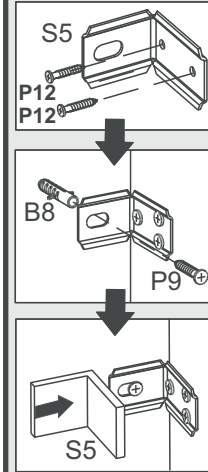

5°

COSTA/REVÉS/BACK

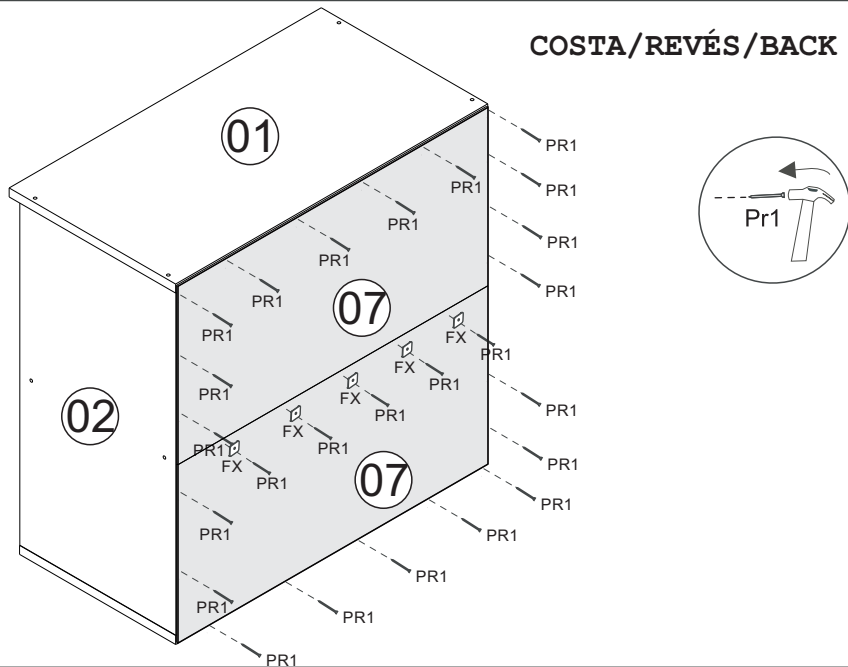

PESO suportado/PESO SOPORTADO/WEIGHT SUPPORTED

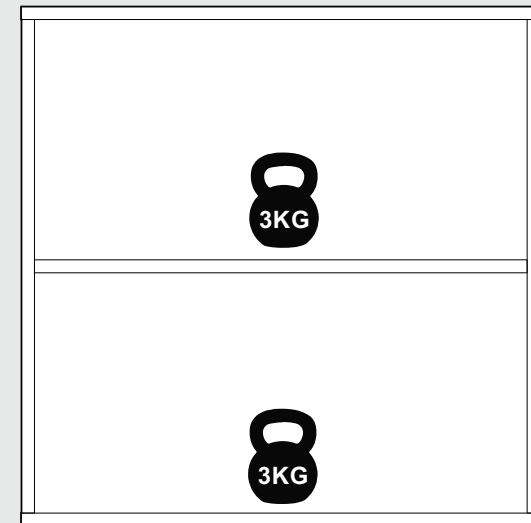

07°

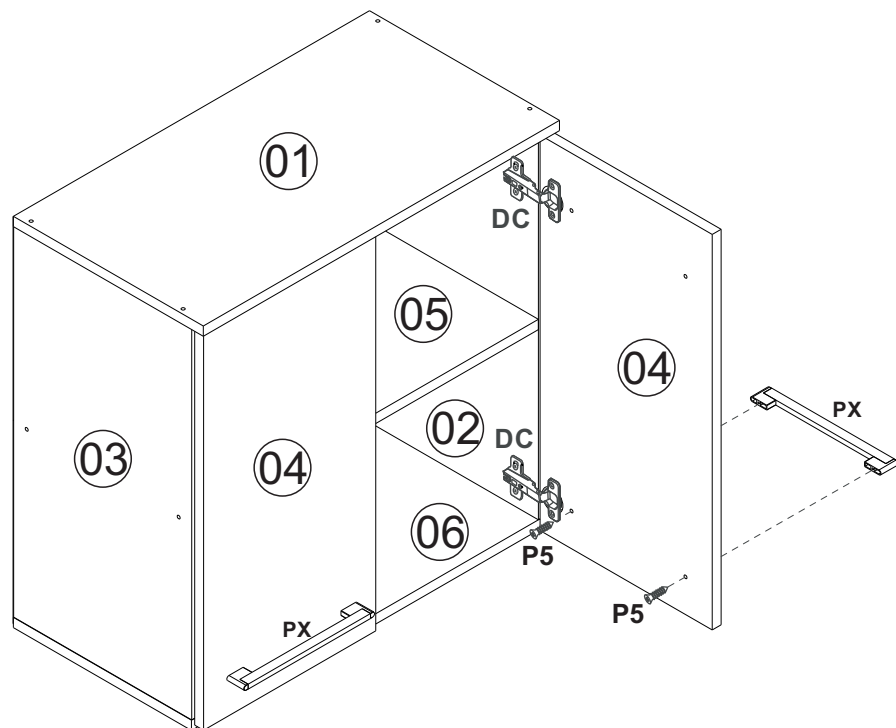

Relação de Peças/ Relación de Piezas/Parts List

N°	CÓDIGO/ CODE	DESCRIÇÃO/ DESCRIPCIÓN/ DESCRIPTION	QTD/ CANT	VOL.
1	0549085	TAMPO/TAPA/TOP	600X320X15MM	1
2	0549083	LATERAL DIR/LATERAL/SIDE	570X300X15MM	1
3	0549084	LATERAL ESQ/LATERAL/SIDE	570X300X15MM	1
4	0549087	PORTA/PUERTA/DOOR	577X290X15MM	2
5	0549086	PRATELEIRA/ESTANTE/SHELF	569X300X15MM	1
6	0549082	BASE	600X300X15MM	1
7	0549088	COSTA/REVÉS/BACK	596X297X2,8MM	2

ATENÇÃO!!!! montadores e consumidores

* Ajustar o torque da parafusadeira para não danificar as peças escareando o parafuso *

ATENCIÓN!!!! montadores e consumidores

* Ajuste el torque del destornillador para no dañar las piezas avallanando el tornillo *

ATTENTION!!!! assemblers and consumers

* Adjust the torque of the screwdriver so as not to damage the parts by countersinking the screw *

ATENÇÃO!!!! montadores e consumidores

* Para limpar o móveis utilize somente um pano úmido (umedecido em água pura ou água com sabão neutro). Depois, passe um pano seco. Evite a umidade excessiva.

* Evite usar álcool, água sanitária, detergente e outros produtos químicos, mesmo diluídos em água. Não utilize produtos abrasivos de nenhuma espécie

ATENCIÓN!!!! montadores e consumidores

* Para limpiar el mueble utilice solamente un paño húmedo (humedecido con agua limpia o con un jabón suave).

A continuación, utilice un paño seco. Evite el exceso de humedad.

* Evite uso de alcohol, hipocloridro solución basada, detergente y otros productos químicos, mismo diluídos en agua. No utilice productos abrasivos de ningún tipo.

ATTENTION!!!! assemblers and consumers

* To clean the furniture, use only a damp cloth (humidify it only in pure water ou water and neutral soap).After, use a dry cloth.Avoid excessive humidity.

*Avoid using alcohol, bleach, detergent and other chemical products, even diluted in water. Do not use any kind of abrasive cleaning agents to clean the furniture.

The use of such products may jeopardize the ?nal characteristics of the furniture.

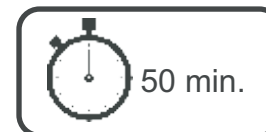

50 min.

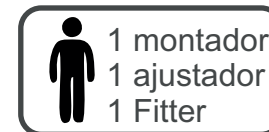

1 montador
1 ajustador
1 Fitter



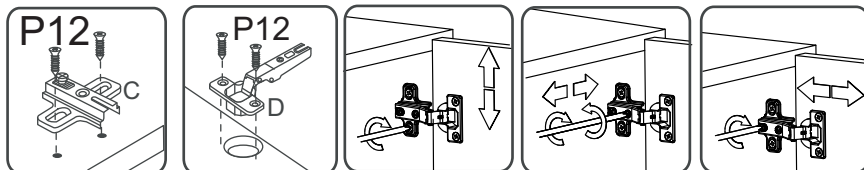



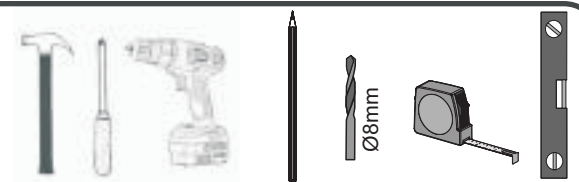

www.decibal.com.br









Ferramente necessárias
Necessary tools
Herramientas necesarias



Ferragens/ Herrajes/ Hardware

		escala (1:1)	
LEGENDA	DESCRIÇÃO/DESCRIPCIÓN/DESCRIPTION	CÓDIGO	QUANT.
P7	 PARAFUSO/TORNILLO/SCREW 4X45	01318	12
PR1	 PREGO/CLAVO/NAIL 10X10	01330	40
C2	 CAVILHA/TARUGO/DOWEL 6X30 MM	01211	13
P5	 PARAFUSO/TORNILLO/SCREW 3,5X25	09955	04
PU	 PARAFUSO UNIÃO/UNIÓN DETORNILLO /SCREW UNION	01495	02
P12	 PARAFUSO/TORNILLO/SCREW 3,5X13	09927	24
P9	 PARAFUSO/TORNILLO/SCREW 6X50	03827	04
B8	 BUCHA / BUJE / BUCHING 8 MM	01311	04

escala (N/A)

LEGENDA	DESCRIÇÃO/DESCRIPCIÓN/DESCRIPTION	CÓDIGO	QUANT.
CL	 COLA/PEGAMENTO/GLUE	01213	01
ET	 ETIQUETA LOGO DECIBAL/LABEL DECIBAL	01312	01
DC	 DOBRADIÇA/BISAGRA/HINGE D=35mm C=0mm	09449	04
S5	 SUPORTE AÉREO/APOYO AÉREO/AIR SUPPORT WOOD 09647	03828	04
Fx	 FIXADOR COSTA/FIJADOR FONDO/FIXER COAST	01331	05
AD	 ADESIVO/ADHESIVO/ADHESIVE NATURALLE 09963 WOOD 09929		08
PX	 PUXADOR / PEGADOR / HANDLE	11020	02

Medida em mm

