

## Componentes / Components

SEQUENCIA	CÓDIGO	DESCRIÇÃO	QTDE	VOLUME
1	FJ-3974	BASE	1	1
2	FJ-0109	LATERAL ESQUERDA INFERIOR – LATERAL IZQUIERDA- LEFT BACK	1	4
3	FJ-1663	DIVISÓRIA CENTRAL INFERIOR – PARTIÇÃO- PARTITION	1	4
4	FJ-4521	PRATELEIRA PARAFUSO – ESTANTE – SHELF	1	1
5	FJ-1654	DIVISÓRIA CENTRAL INFERIOR – PARTIÇÃO- PARTITION	1	4
6	FJ-4520	PRATELEIRA PARAFUSO INFERIOR – ESTANTE – SHELF	1	1
7	FJ-1652	DIVISÓRIA INFERIOR/GAVETAS – PARTIÇÃO- PARTITION	1	4
8	FJ-4522	PRATELEIRA PARAFUSO – ESTANTE- SHELF	1	1
9	FJ-0101	LATERAL DIREITA INFERIOR – LATERAL DERECHA – RIGHT BACK	1	4
10	AC-2477	SARRAFO DE APOIO – BATTEN	1	3
11	FJ-3975	TAMPO DO GABINETE – TAPA DEL ARMARIO – CABINET TOP	1	1
12	FJ-0107	LATERAL ESQUERDA SUPERIOR – LATERAL IZQUIERDO- LEFT BACK	1	3
13	FJ-1659	DIVISORA ESQUERDA SUPERIOR – PARTIÇÃO- PARTITION	1	3
14	FJ-4526	PRATELEIRA PARAFUSO – ESTANTE-SHELF	2	3
15	FJ-1660	DIVISÓRIA DIREITA SUPERIOR – PARTIÇÃO- PARTITION	1	2
16	FJ-0108	LATERAL DIREITA SUPERIOR- LATERAL DERECHA- RIGHT BACK	1	3
17	FJ-4524	PRATELEIRA ESTREITA – ESTANTE-SHELF	1	3
18	FJ-1661	DIVISÓRIA PEQUENA – PARTIÇÃO- PARTITION	1	3
19	FJ-4523	PRATELEIRA CENTRAL – ESTANTE- SHELF	1	2
20	FJ-1662	DIVISÓRIA SUPERIOR – MEDIA – PARTIÇÃO – PARTITION	1	1
21	FJ-4525	PRATELEIRA PARAFUSO – ESTANTE-SHELF	1	3
22	FJ-4519	PRATELEIRA- ESTANTE-SHELF	1	3
23	FJ-4514	PRATELEIRA BASE NICHOS – ESTANTE- SHELF	1	3
24	FJ-1651	DIVISÓRIA DO NICHOS – PARTIÇÃO- PARTITION	3	3
25	FJ-3976	TAMPO SUPERIOR – TAPA – TOP	1	1
26	CH-6286	FRENTE DE GAVETA – FRENTE DE CAJÓN- DRAWER FRONT	3	2
27	FJ-8297	LATERAL DE GAVETA – LADO DEL CAJÓN- DRAWER SIDE	6	1
28	FJ-8299	TRASEIRO DE GAVETA – PARTE TRASERA DEL CAJÓN- DRAWER BACK	3	2
29	DP-7343	FUNDO DE GAVETA – FONDO – BOTTOM	3	1
30	DI-7341	FUNDO SUPERIOR – FONDO – BOTTOM (1090X460X3)	1	1
31	DT-7349	FUNDO – FONDO – BOTTOM (685X460X3)	1	1
32	DI-7344	FUNDO SUPERIOR – FONDO -BOTTOM (1088X555X3)	1	2
33	DI-7350	FUNDO CENTRAL – FONDO- BOTTOM (1088X534X3)	1	2
34	DI-7345	FUNDO INFERIOR – FONDO – BOTTOM (1088X685X3)	1	2
35	DI-7342	FUNDO – FONDO – BOTTOM (1090X586X3)	1	2
36	DI-7373	FUNDO INFERIOR – FONDO- BOTTOM (685X586X30)	1	2
37	CH-5588	PORTA – PUERTA – DOOR	3	2
38	CH-5587	PORTA BASCULANTE – PUERTA- DOOR	1	2
39	CH-5584	PORTA INFERIOR- PUERTA- DOOR	1	2
40	CH-5581	PORTA -PUERTA- DOOR	3	2



**BATROL - Indústria e Comércio e Móveis Ltda.**  
 Av. Pedro Baso 476 - Recanto Jd. Dalva - 13660-000 - Porto Ferreira - SP - Brasil  
 Telefone: PABX (19) 3581-4123 / (19) 3589-5123  
 Caixa Postal : 580 CNPJ: 48.024.392/001-55 Insc. Est: 555.011.453.112  
 e-mail: batrol@batrol.com.br Site: www.batrol.com.br



Vídeo Montagem -  
 Montaje - Drawing - Youtube



SMARTPHONE, TABLET,  
 PDAs, E SIMILARES COM  
 CONEXÃO COM INTERNET.

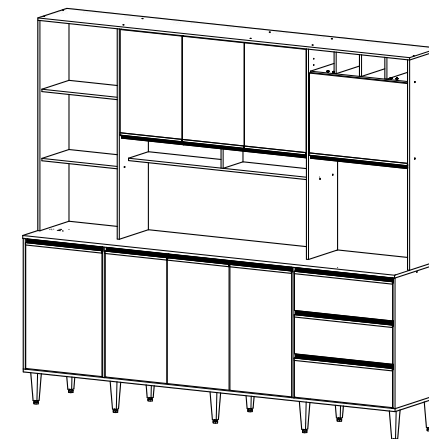

**Altura - Height: 1945 mm**  
**Frente - Front: 2140 mm**  
**Prof. Total - Total Depth: 445 mm**

Armário de Cozinha - mueble de cocina -  
 kitchen cabinet

Instruções - Instructions - Instrucciones:

REVISÃO: 00 - 09/04/2025

- Siga corretamente as instruções deste manual - Siga correctamente las instrucciones de estos manuales - Follow the instructions in this manual correctly

- Ferramentas para a montagem - Herramientas para el montaje - Tools for assembly:



**Parafusadeira  
 Atornillador  
 Screwdriver**



**Chave Philips  
 Destorn. Estrela  
 Phillips Head**



**Martelo  
 Martillo  
 Hammer**



**Esquadro  
 Escuadra  
 Square**

1- Use a embalagem para apoiar o produto - Utilice el embalaje para apoyar el producto - Use the packaging to support the product.

2- Separe os acessórios - Separe los accesorios - Separate the accessories.

3- Não improvise ferramentas - No improvise herramientas - Do not improvise tools.

4- Passe colas nas cavilhas - Coloca pegamento em las clavijas - Pass glues on the pegs.

5- Esquadre antes de fixar o fundo - Escuadra antes de fijar el fondo - Square before fixing the bottom

Uso e limpeza - Uso y limpieza - Use and cleaning:

- Distribua o peso nas gavetas - Distribuye el peso em los cajones - Distribute the weight in the drawers.

- Sempre mude o produto vazio - Cambiar siempre el producto vacio - Always change the empty product.

- Limpe somente com pano seco ou pouco úmido - Limpie solo com um paño seco o poco húmedo - Wipe only with dry or slightly damp cloth.

LINHA VERSATI/ LINHA VERSATI/ VERSATI LINE

08.7043

MONTAJE - DRAWING

MONTAGEM - MONTAJE - DRAWING

CÓPIA CONTROLADA

1/6

# PARTE 1

PART 1

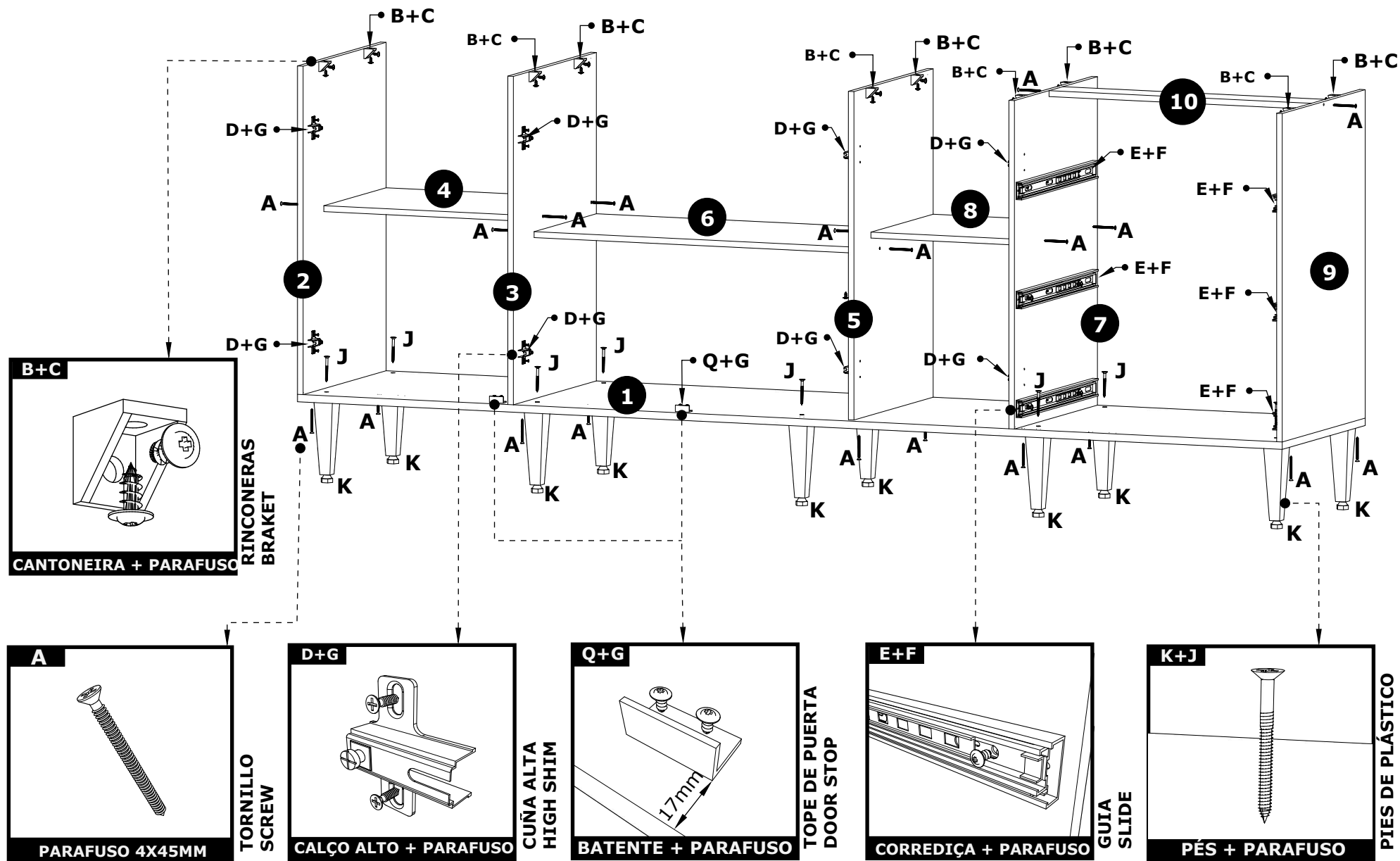

SIGA A SEQUENCIA DE MONTAGEM - SIGA LA SECUENCIA DE MONTAJE - FOLLOW THE ASSEMBLY SEQUENCE

# PARTE 2

PART 2

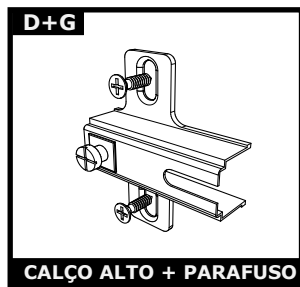

CUÑA ALTA  
HIGH SHIM



CLAVIJA + PEGAMENTO  
PIN + GLUE

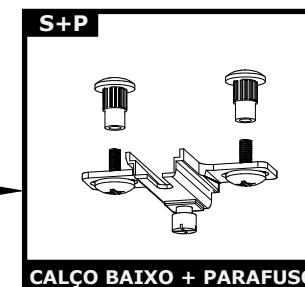
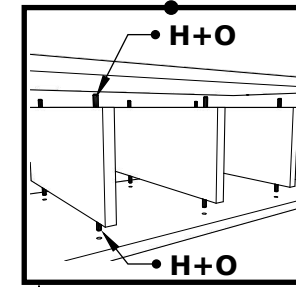

CUÑA BAJA  
LOW SHIM



TORNILLO  
SCREW

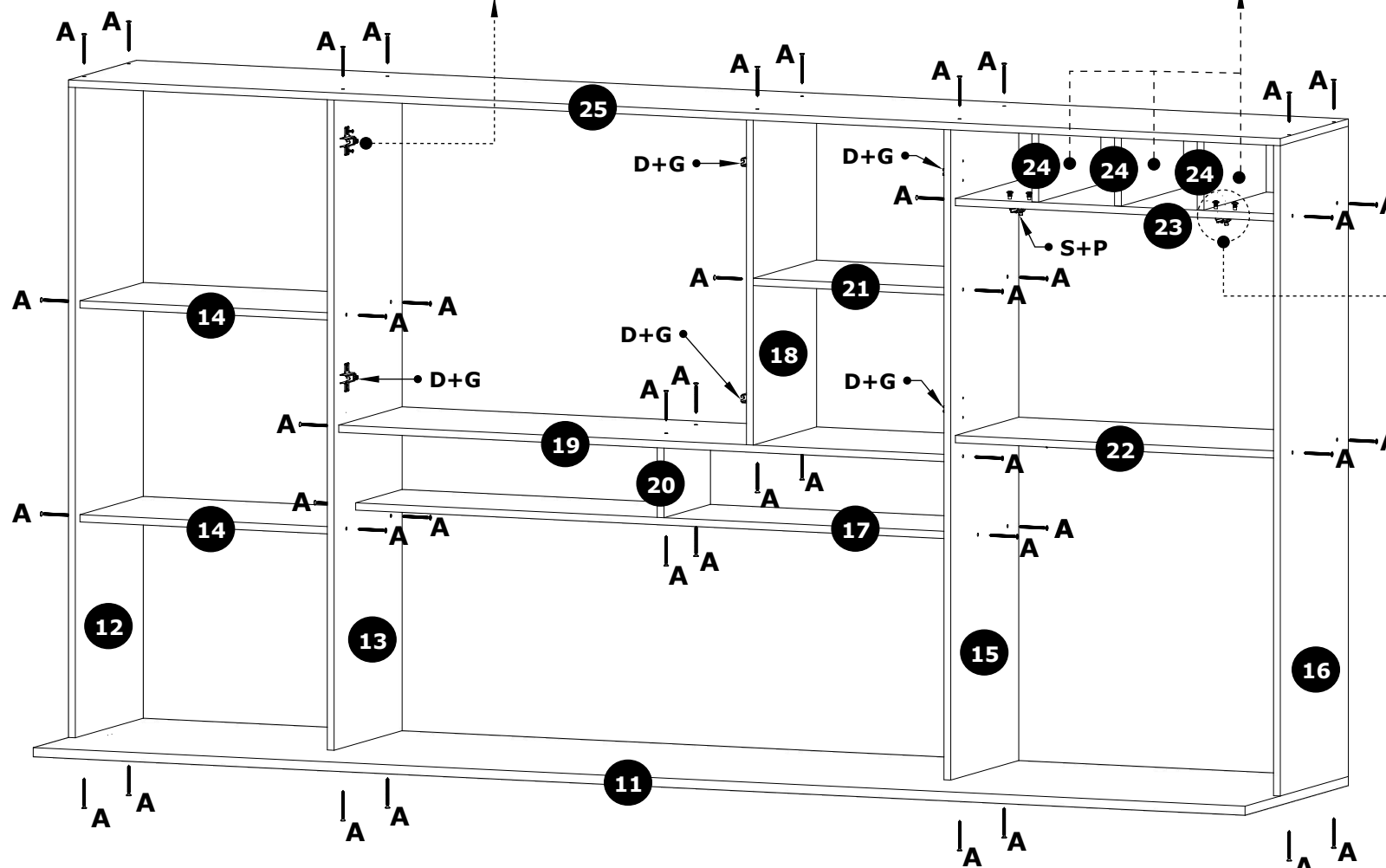

SIGA A SEQUENCIA DE MONTAGEM - SIGA LA SECUENCIA DE MONTAJE - FOLLOW THE ASSEMBLY SEQUENCE

### MONTAGEM DAS GAVETAS

MONTAJE DE LOS CAJONES - MOUNTING THE DRAWERS

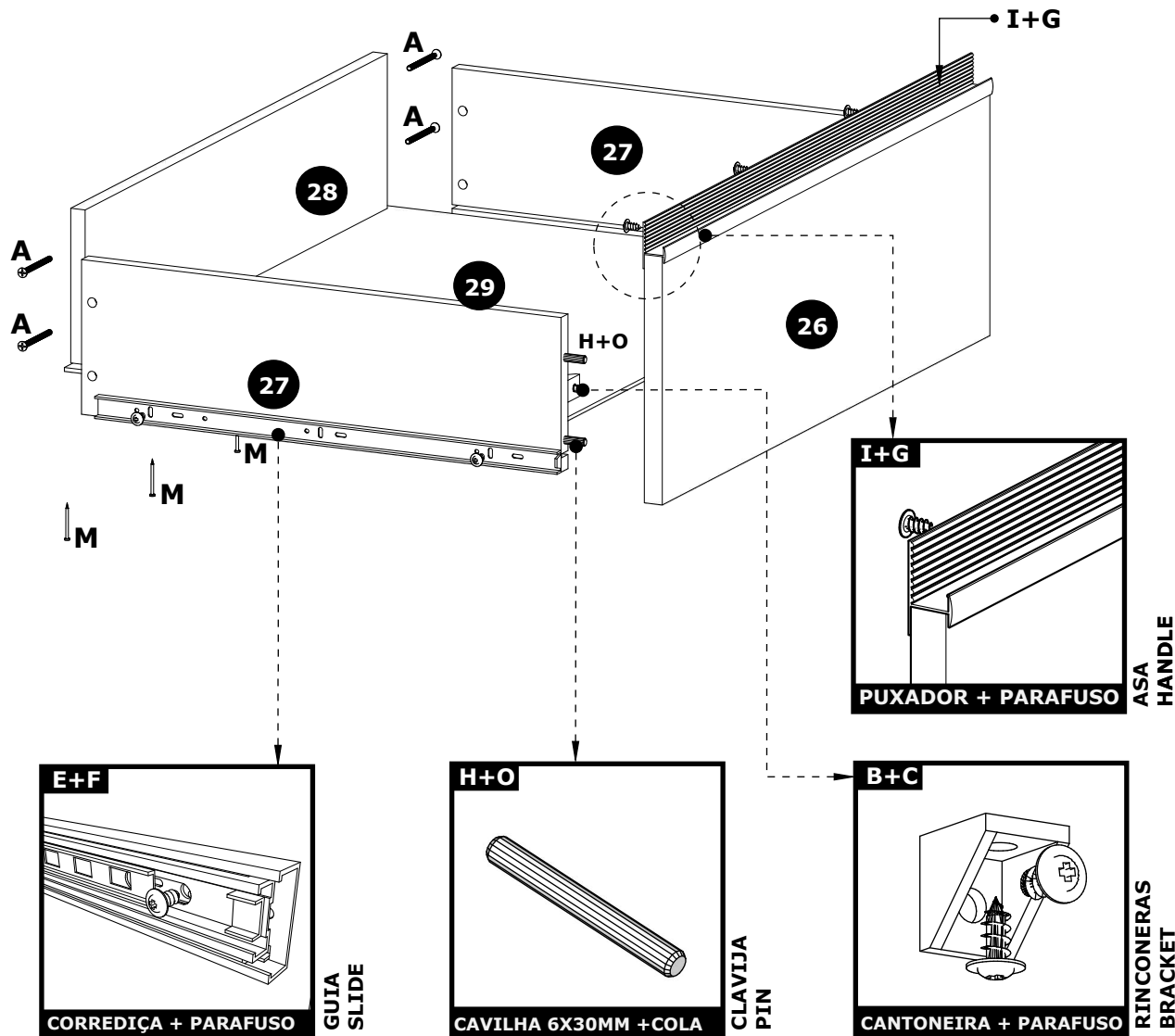

### MONTAGEM DOS FUNDOS

AJUSTE DE LA ESPALDA - FITTING OF THE BACK

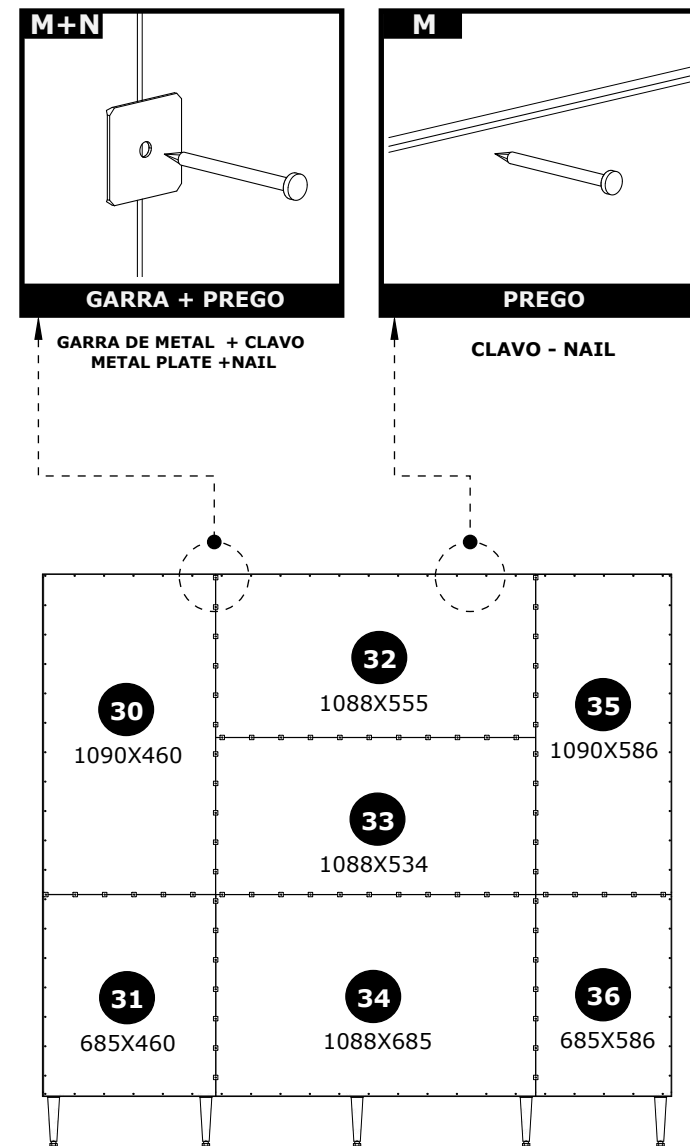

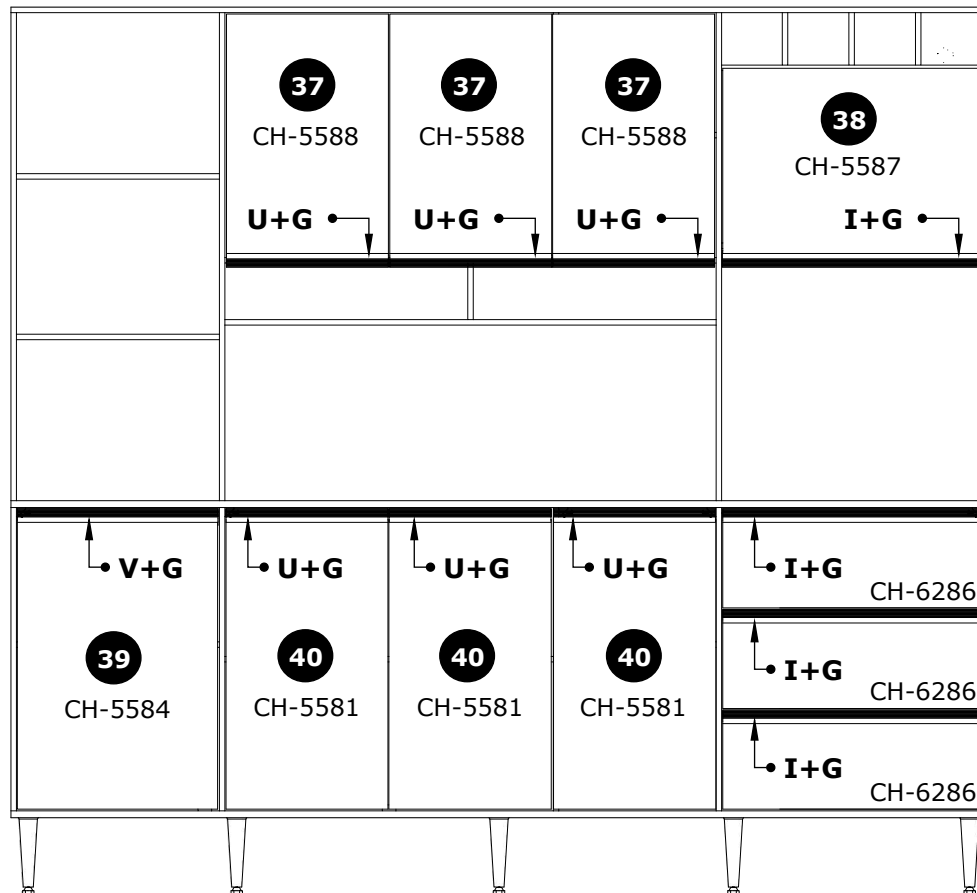

### MONTAGEM DAS PORTAS

MONTAJE DE LA PUERTA - MOUNTING THE DOOR

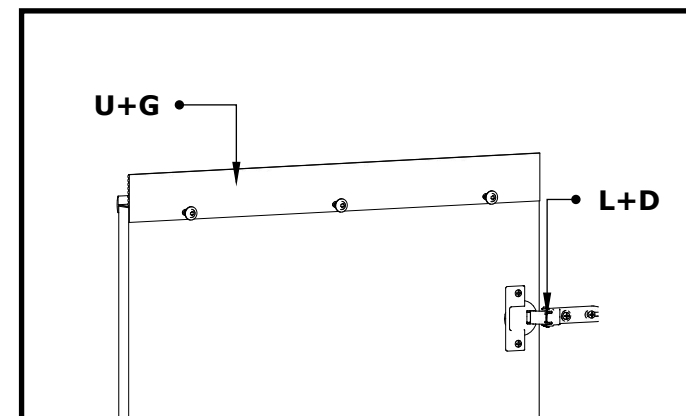

### MONTAGEM DA PORTA BASCULANTE

MONTAJE DE LA PUERTA BATIENTE - MOUNTING THE SWING DOOR

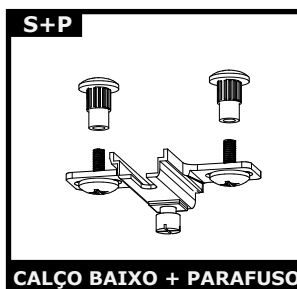
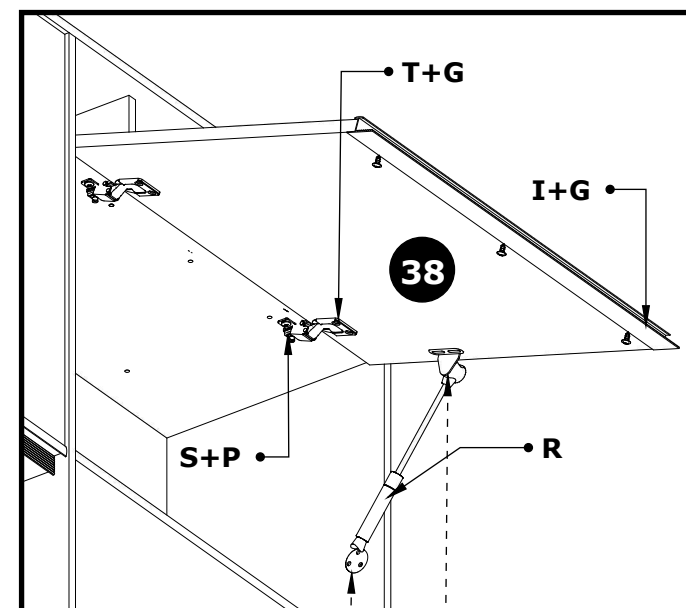

CUÑA + TORNILLO  
SHIM + SCREW

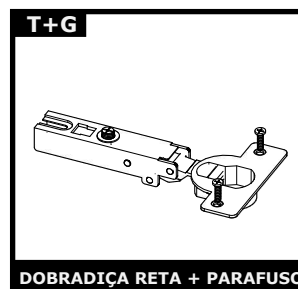

BISAGRA RECTA  
STRAIGHT HINGE

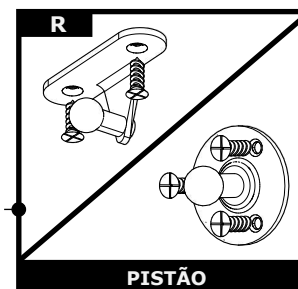

PISTON DE PRESSÃO  
PRESSURE PISTON

SIGA A SEQUENCIA DE MONTAGEM -  
SIGA LA SECUENCIA DE MONTAJE -  
FOLLOW THE ASSEMBLY SEQUENCE.

**Acessórios / Acesoio / Accessory**

<b>A</b> Parafuso - Tornillo - Screw 4 x 45mm  88 Pçs	<b>B</b> Cantoneira Plástica - Rinconeras - Bracket plastic  16 Pçs	<b>C</b> Parafuso flangeado - Tornillo con brida Screw flanged 3,5 x 12mm  59 Pçs	<b>D</b> Calço alto Cuña alta High Shim  12 Pçs
<b>E</b> Corrediza 350m mGuia 350mm Slide 350mm  03 prs	<b>F</b> Parafuso - Tornillo - Screw 4 x 12mm  36 Pçs	<b>G</b> Parafuso Tornillo Screw 3,5x12mm  60 Pçs	<b>H</b> Cavilha - Clavija - Pin 6x30mm  30 Pçs
<b>I</b> Puxador-Asa- Knob 564mm  04 Pçs	<b>J</b> Parafuso Philips Tornillo - Screw 4,8 x 50mm  10 Pçs	<b>K</b> Pés de plástico - Pies de plástico - plastic feet  10 Pçs	<b>L</b> Dobradiça Bisagra Hinge  12 Pçs
<b>M</b> Prego - Clavo - Nail 10x10  150 Pçs	<b>N</b> Garra de metal- plate metal  25 Pçs	<b>O</b> Cola - Pegamento - Glue  03 Pçs	<b>P</b> Parafuso de união - Tornillo de union - Connecting Screw 12mm  04 Pçs
<b>Q</b> Batente de porta - Tope de puerta - Door stop  01 Pç	<b>R</b> Pistão - Pistón de presión - Pressure piston  01 Pç	<b>S</b> Calço baixo Cuña baixa Shim  02 Pçs	<b>T</b> Dobradiça reta Bisagra recta Straight hinge  02 Pçs
<b>U</b> Puxador-Asa- Knob 354mm  06 Pçs	<b>V</b> Puxador-Asa- Knob 439mm  01 Pç		

**Códigos/Códigos/Code**

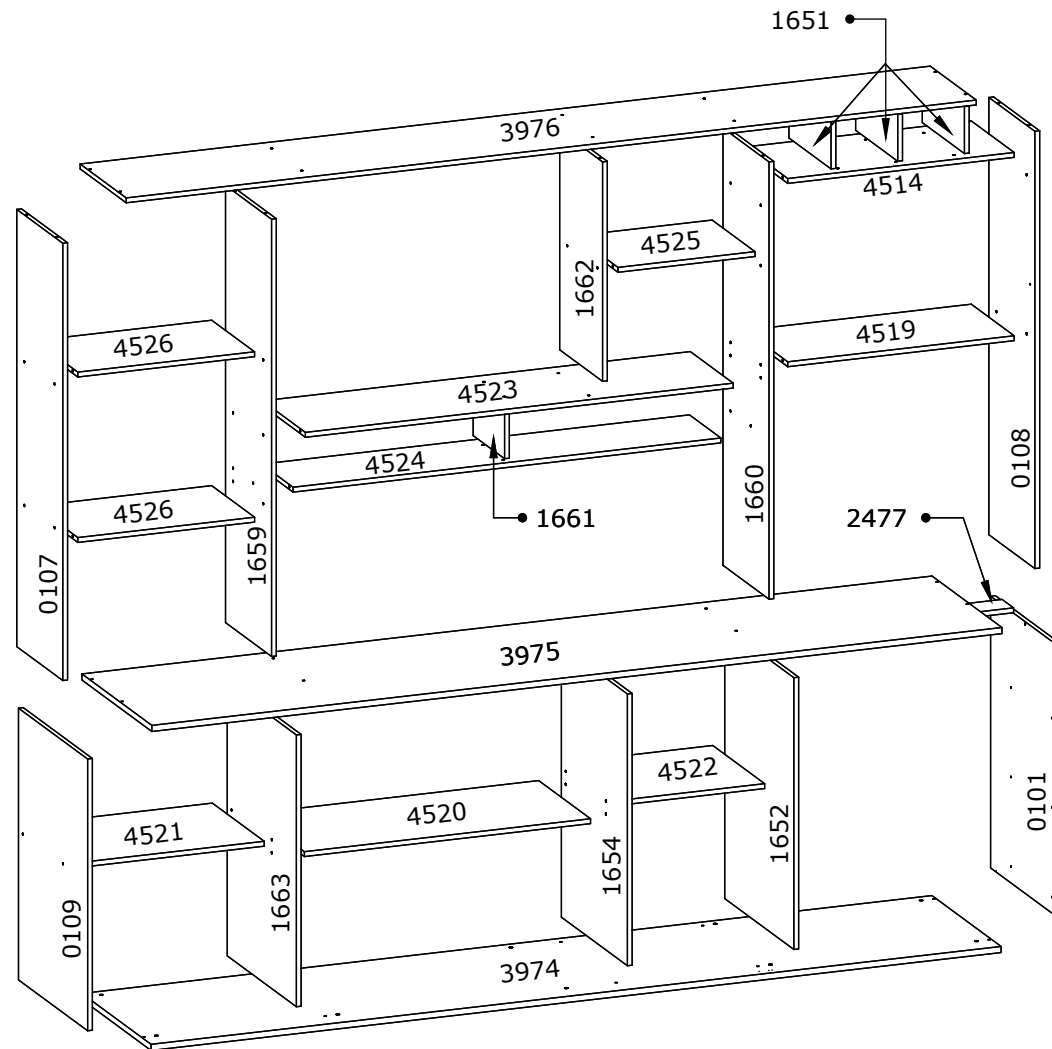

\*Medidas em mm - Medidas em mm - Measurements in mm

\*Desenhos ilustrativos - Dibujos ilustrativos - Illustrative drawings