



JCM
movelaria

CABECEIRA SONHAR QUEEN/KING
SONHAR HEADBOARD QUEEN/KING
CABECERA SONHAR QUEEN/KING

xmount



ENCONTRE UM MONTADOR
FAÇA SEU ORÇAMENTO

▶ BAIXE O APP

Cupom: JCM30



Indicamos que a montagem dos produtos seja realizada com parafusadeira eléctrica e por um montador profissional.
We recommend that a professional furniture assembler assemble the product by using a cordless screwdriver.
Se recomienda que un montador de muebles profesional realice el montaje del producto con un destornillador eléctrico.

AVISO: Não nos comprometemos pelo mal-uso, montagem e fixação do produto à parede. Portanto, não somos responsáveis por danos e quedas do produto, eletrônicos e pertences neles contidos. É importante o uso de brocas e ferramentas compatíveis na montagem.
NOTICE: The company is not responsible for the misuse, assembly, and wall fixation, as well as the damages and falls that the products, electronics, and belongings therein might suffer. It is important to use suitable drills and tools to assemble the product.
ATENCIÓN: La empresa no se responsabiliza del mal uso, montaje y fijación del producto a la pared, así como de daños y caídas del producto, electrónicos u objetos. Es importante el uso de taladros y herramientas compatibles con el montaje.

Dica: para evitar possíveis avarias, use a embalagem do produto como apoio durante a montagem.
Tip: to avoid damages, use the product packaging as a base during the assembly.
Pista: para evitar daños, use el envase del producto como apoyo durante el montaje.

RELAÇÃO DE FERRAGENS | **HARDWARE LIST** | *LISTADO DE HERRAJES*

BUCHA GESSO 10mm	(A)	10mm DRYWALL ANCHOR	(A)	TACO PARA YESO 10 mm	(A)		04
CONECTOR 2 FUROS	(B)	2-HOLE CORNER BRACKET	(B)	SOPORTE ANGULAR 2 AGUJEROS	(B)		03
PARAFUSO 3,5x35	(C)	3.5x35 SCREW	(C)	TORNILLO 3,5x35	(C)		18
PARAFUSO 4x25	(D)	4x25 SCREW	(D)	TORNILLO 4x25	(D)		30
PARAFUSO 3,5x14 FLANG.	(E)	3.5x14 FLANGE SCREW	(E)	TORNILLO TIPO FLANGE 3,5x14	(E)		06
PARAFUSO 7x60	(F)	7x60 SCREW	(F)	TORNILLO 7x60	(F)		04
SACHÊ DE COLA	(G)	GLUE SACHET	(G)	BOLSITA DE PEGAMENTO	(G)		01

RELAÇÃO DE PEÇAS | PARTS LIST | LISTADO DE PARTES

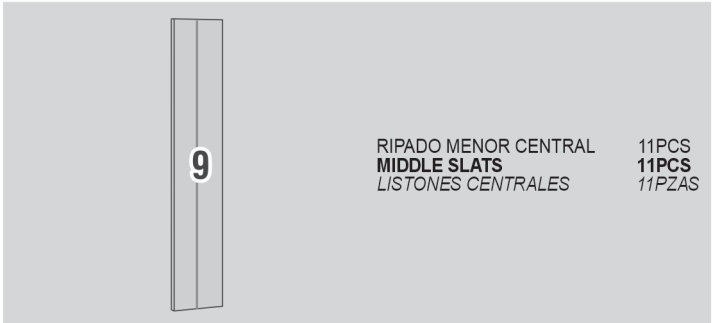
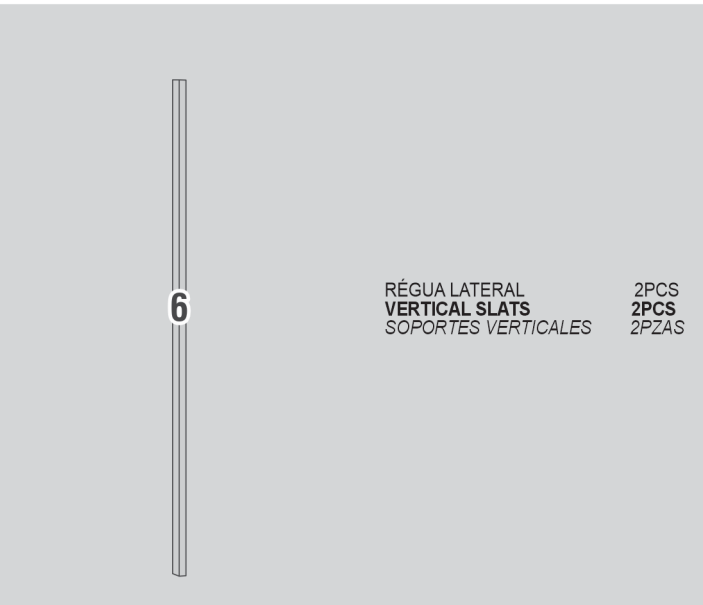
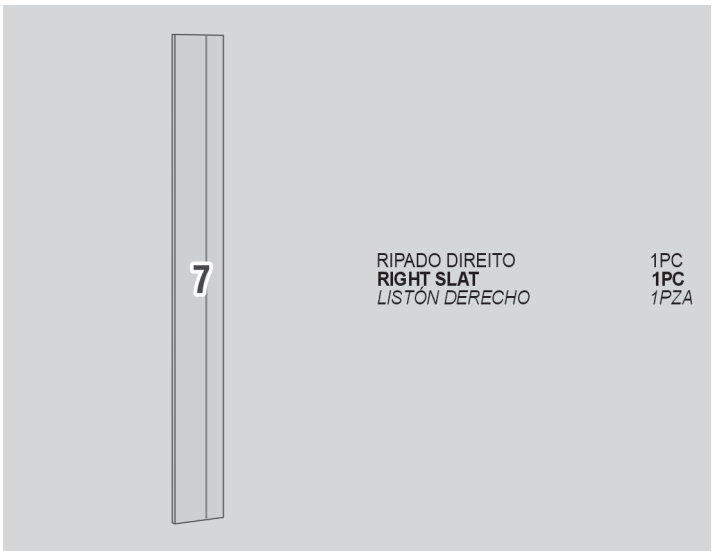
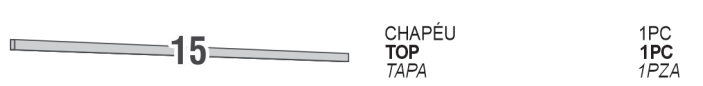
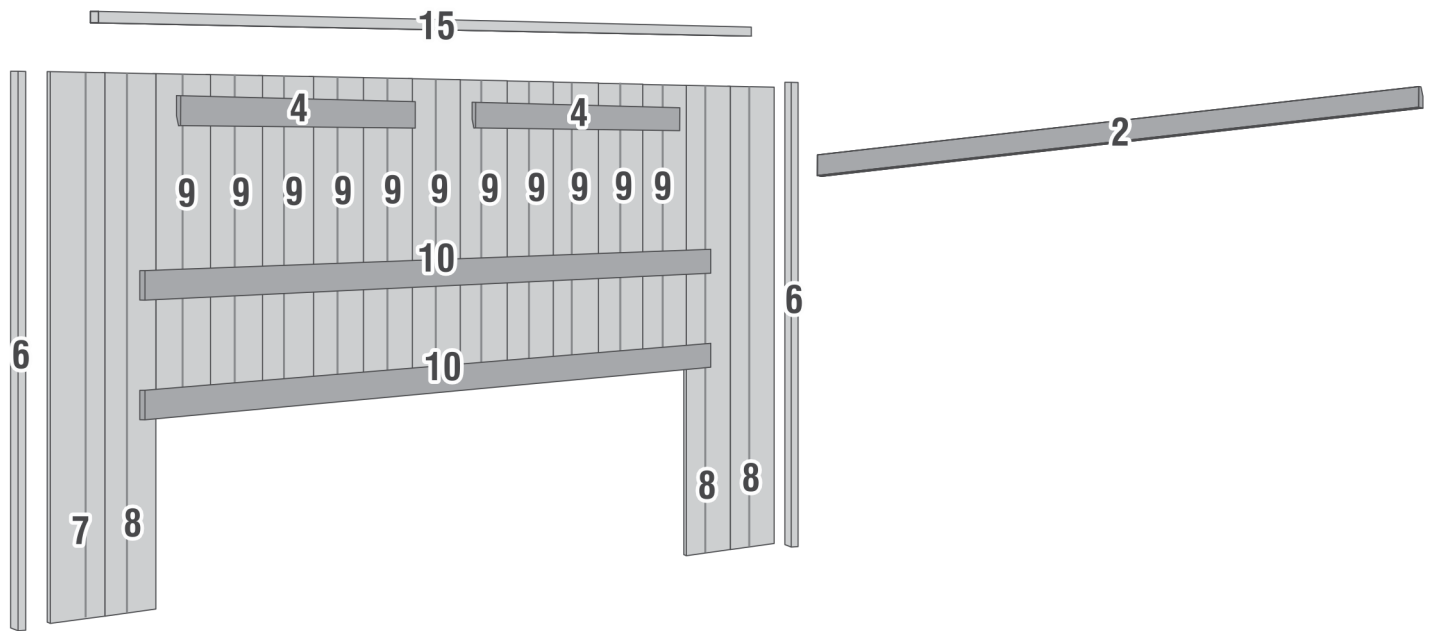

Passo 01 PARAFUSE AS PEÇAS 6 NAS PEÇAS 7 E 8 COM PARAFUSO 3,5x35 (C).
 Step 01 ATTACH PARTS 6 TO PARTS 7 AND 8 WITH 3.5x35 SCREWS (C).
 Paso 01 FIJE LAS PARTES 6 A LAS PARTES 7 Y 8 CON TORNILLOS 3,5x35 (C).

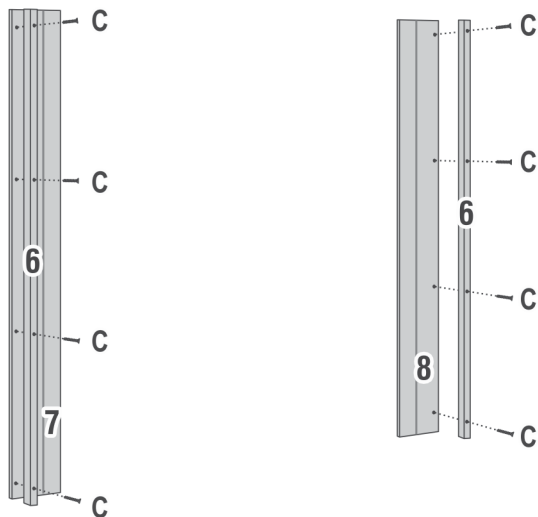

VISTA TRASEIRA
 BACK VIEW
 VISTA TRASERA



Passo 02 FAÇA A UNIÃO DAS PEÇAS 7, 8 E 9.
 Step 02 PUT PARTS 7, 8, AND 9 TOGETHER.
 Paso 02 UNA LAS PARTES 7, 8 Y 9.

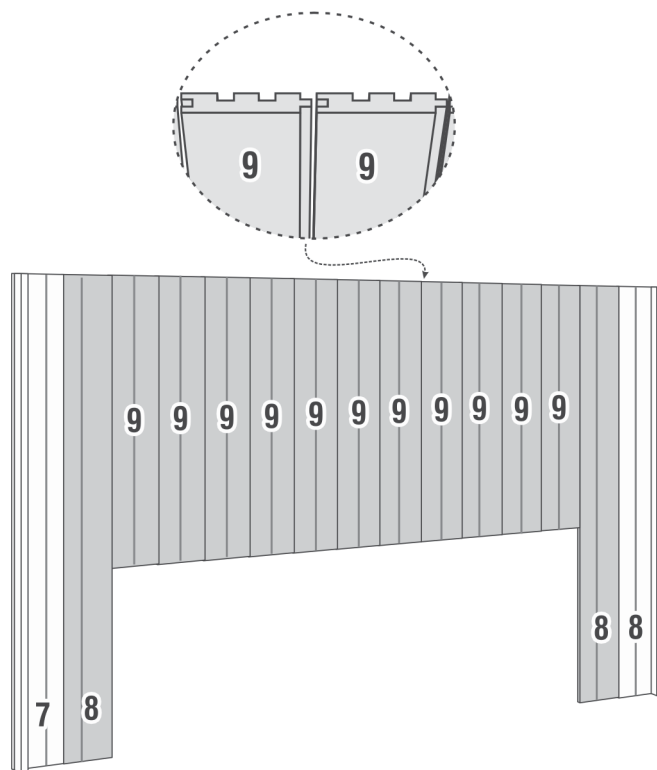

VISTA TRASEIRA
 BACK VIEW
 VISTA TRASERA

Passo 03 PARAFUSE AS PEÇAS 10 NAS PEÇAS 7, 8 E 9 COM PARAFUSO 4x25(D), SEGUINDO AS LINHAS DEMONSTRATIVAS.
 Step 03 FOLLOW THE MARKS TO ATTACH PARTS 10 TO PARTS 7, 8, AND 9 WITH 4x25 SCREWS (D).
 Paso 03 OBSERVE LAS MARCACIONES PARA FIJAR LAS PARTES 10 A LAS PARTES 7, 8 Y 9 CON TORNILLOS 4x25 (D).

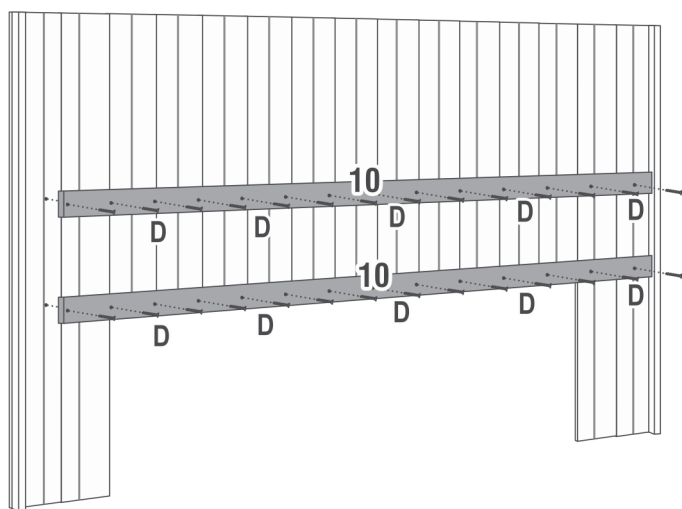

VISTA TRASEIRA
 BACK VIEW
 VISTA TRASERA

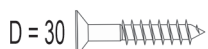

Passo 04 PARAFUSE AS PEÇAS 4 NAS LINHAS DEMONSTRATIVAS COM PARAFUSO 3,5x35 @, USANDO COLA (G) NELAS.
 Step 04 APPLY GLUE (G) TO PARTS 4 AND FASTEN THEM TO THE MARKS WITH 3.5x35 SCREWS (C).
 Paso 04 SEGÚN LAS MARCACIONES, APLIQUE PEGAMENTO (G) A LAS PARTES 4 Y FIJELAS CON TORNILLOS 3,5x35 (C).

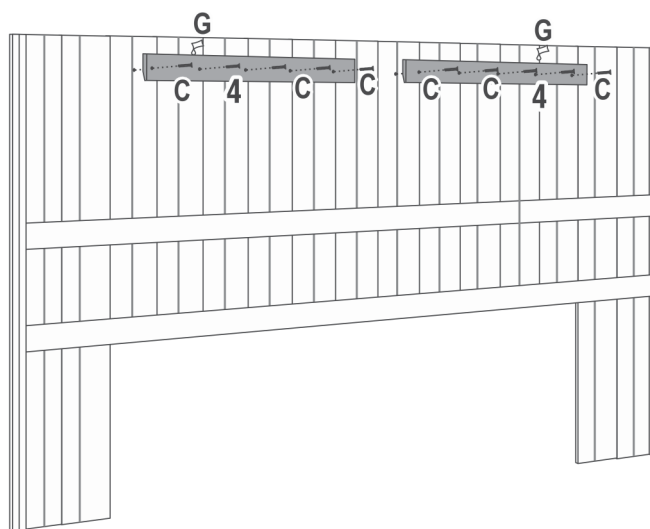

VISTA TRASEIRA
 BACK VIEW
 VISTA TRASERA



Passo 05 COM A CABECEIRA DE PÉ, PARAFUSE A PEÇA 15 ALINHADA COM AS PEÇAS 6 COM CONECTOR 2 FUROS (B+E).

Step 05 WITH THE HEADBOARD UPRIGHT, ALIGN PART 15 WITH PARTS 6 AND FASTEN THEM WITH 2-HOLE CORNER BRACKET (B+E).

Paso 05 CON LA CABECERA DE PIE, ALINEE LA PARTE 15 CON LAS PARTES 6 Y FUELAS CON SOPORTES ANGULARES 2 AGUJEROS (B+E).

ATENÇÃO: ALINHE A PEÇA 5 COM AS PEÇAS 6 PARA PARAFUSAR.
NOTE: ALIGN PART 5 WITH PARTS 6 BEFORE FASTENING THEM.
¡ATENCIÓN! ALINEE LA PARTE 5 CON LAS PARTES 6 ANTES DE ATORNILLAR.

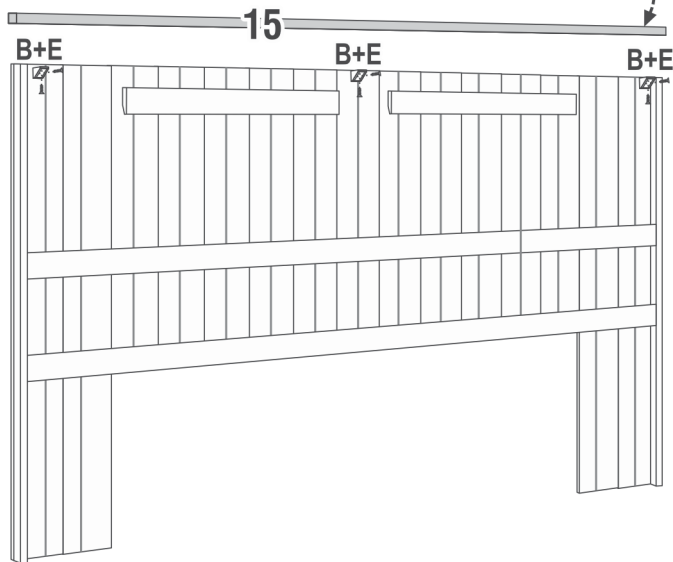

VISTA TRASEIRA
BACK VIEW
VISTA TRASERA

B=3 

E=6 

Passo 06 PARAFUSE A PEÇA 2 NA PAREDE COM PARAFUSO 7x60 (F) E BUCHA GESSO 10mm (A).

Step 06 SCREW PART 2 TO THE WALL WITH 7x60 SCREWS (F) AND 10mm DRYWALL ANCHORS (A).

Paso 06 ATORNILLE LA PARTE 2 A LA PARED CON TORNILLOS 7x60 (F) Y TACOS PARA YESO 10 mm (A).

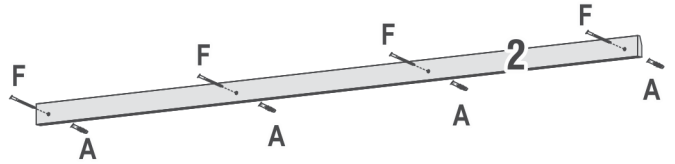

A=4 

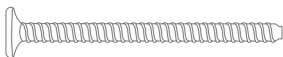
F=4 

Passo 07 INSTALE A CABECEIRA, ENCAIXANDO NA PEÇA 2 JÁ FIXADA NA PAREDE.

Step 07 MOUNT THE HEADBOARD TO THE WALL BY ALIGNING IT WITH PART 2.

Paso 07 ALINEE LA CABECERA Y ENCÁJELA EN LA PARTE 2.

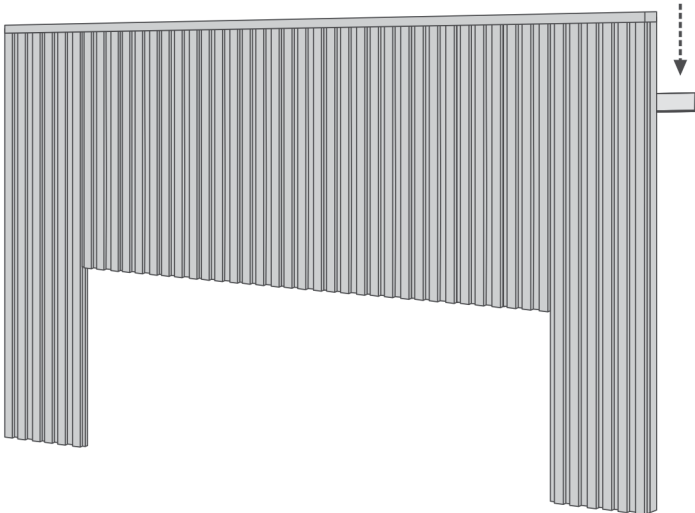

Passo 08 PRODUTO MONTADO.

Step 08 PRODUCT ASSEMBLED.

Paso 08 PRODUCTO ARMADO.

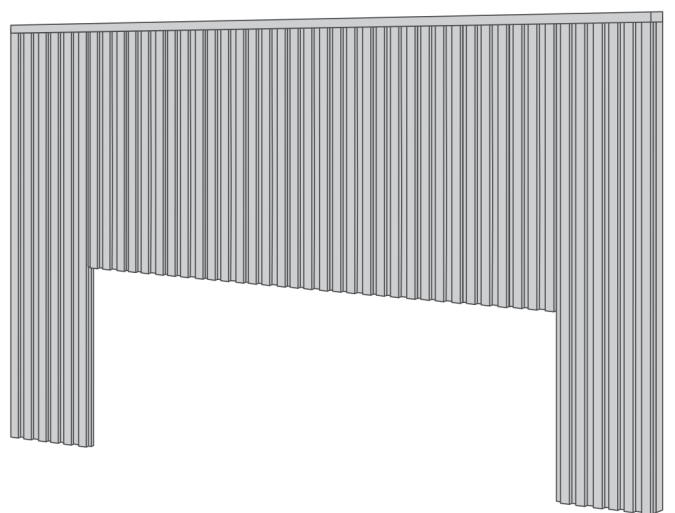



JCM
movelaria

MÓDULO MESA DE CABECEIRA SONHAR SONHAR HEADBOARD WITH NIGHTSTAND CABECERA CON MESA DE NOCHE



Cupom: JCM30















Indicamos que a montagem dos produtos seja realizada com parafusadeira eléctrica e por um montador profissional.
We recommend that a professional furniture assembler assemble the product by using a cordless screwdriver.
Se recomienda que un montador de muebles profesional realice el montaje del producto con un destornillador eléctrico.

AVISO: Não nos comprometemos pelo mal-uso, montagem e fixação do produto à parede. Portanto, não somos responsáveis por danos e quedas do produto, eletrônicos e pertences neles contidos. É importante o uso de brocas e ferramentas compatíveis na montagem.
NOTICE: The company is not responsible for the misuse, assembly, and wall fixation, as well as the damages and falls that the products, electronics, and belongings therein might suffer. It is important to use suitable drills and tools to assemble the product.
ATENCIÓN: La empresa no se responsabiliza del mal uso, montaje y fijación del producto a la pared, así como de daños y caídas del producto, electrónicos u objetos. Es importante el uso de taladros y herramientas compatibles con el montaje.

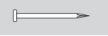
Dica: para evitar possíveis avarias, use a embalagem do produto como apoio durante a montagem.
Tip: to avoid damages, use the product packaging as a base during the assembly.
Pista: para evitar daños, use el envase del producto como apoyo durante el montaje.

RELAÇÃO DE FERRAGENS | HARDWARE LIST | LISTADO DE HERRAJES

ARGOLA PUXADOR	(A)	PULL RING	(A)	ANILLA DEL TIRADOR	(A)		01
BUCHA GESSO 10mm	(B)	10mm DRYWALL ANCHOR	(B)	TACO PARA YESO 10 mm	(B)		02
CAVILHA 6x30	(C)	6x30 DOWEL	(C)	CLAVIJA 6x30	(C)		06
CONECTOR 2 FUROS	(D)	2-HOLE CORNER BRACKET	(D)	SOPORTE ANGULAR 2 AGUJEROS	(D)		04
PARAFUSO 3,5x14	(E)	3.5x14 SCREW	(E)	TORNILLO 3,5x14	(E)		08
PARAFUSO 3,5x35	(F)	3.5x35 SCREW	(F)	TORNILLO 3,5x35	(F)		10
PARAFUSO 4x25	(G)	4x25 SCREW	(G)	TORNILLO 4x25	(G)		04
PARAFUSO 3,5x14 FLANG.	(H)	3.5x14 FLANGE SCREW	(H)	TORNILLO TIPO FLANGE 3,5x14	(H)		08
PARAFUSO 7x60	(I)	7x60 SCREW	(I)	TORNILLO 7x60	(I)		02
PARAFUSO 5x40	(J)	5x40 SCREW	(J)	TORNILLO 5x40	(J)		10
PARAFUSO MINIFIX	(K)	MINIFIX BOLT	(K)	PERNO MINIFIX	(K)		04
PARAFUSO 3/16x1"	(L)	3/16x1" SCREW	(L)	TORNILLO 3/16x1"	(L)		01
PORCA 3/16	(M)	3/16 NUT	(M)	TUERCA 3/16	(M)		01
PREGO 8x8	(N)	8x8 NAIL	(N)	CLAVO 8x8	(N)		04
PUXADOR COURO	(O)	LEATHER PULL	(O)	TIRADOR DE CUERO	(O)		01
SACHÊ DE COLA	(P)	GLUE SACHET	(P)	BOLSITA DE PEGAMENTO	(P)		01
TAMBOR MINIFIX	(Q)	MINIFIX CAM LOCK	(Q)	CAJA DEL MINIFIX	(Q)		04

RELAÇÃO DE PEÇAS | PARTS LIST | LISTADO DE PARTES

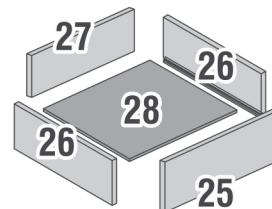
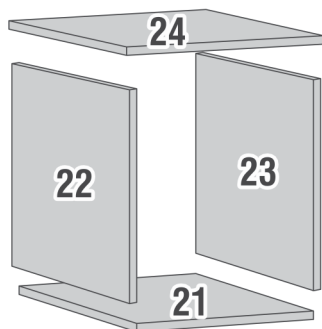
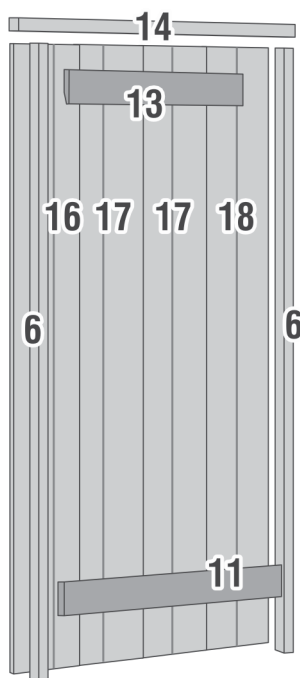

RÉGUA LATERAL
VERTICAL SLATS
SOPORTES VERTICALES

2PCS
2PCS
2PZAS

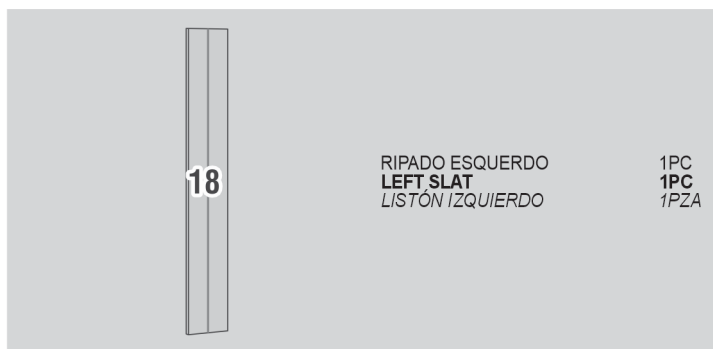

RIPADO ESQUERDO
LEFT SLAT
LISTÓN IZQUIERDO

1PC
1PC
1PZA



RÉGUA SUPORTE
LOWER SUPPORT
SOPORTE INFERIOR

1PC
1PC
1PZA



BASE NICHU
NIGHTSTAND BOTTOM
BASE MESA DE NOCHE

1PC
1PC
1PZA



RÉGUA PAREDE
WALL MOUNT
SOPORTE DE PARED

1PC
1PC
1PZA



LATERAL ESQUERDA NICHU
NIGHTSTAND LEFT SIDE
LATERAL IZQUIERDO MESA DE NOCHE

1PC
1PC
1PZA

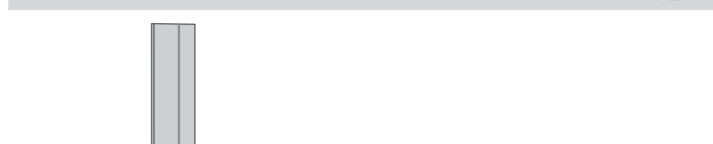

RÉGUA REBAIXADA
TOP SUPPORT
SOPORTE SUPERIOR

1PC
1PC
1PZA



LATERAL DIREITA NICHU
NIGHTSTAND RIGHT SIDE
LATERAL DERECHO MESA DE NOCHE

1PC
1PC
1PZA



RIPADO DIREITO
RIGHT SLAT
LISTÓN DERECHO

1PC
1PC
1PZA



TAMPO NICHU
NIGHTSTAND TOP
TAPA MESA DE NOCHE

1PC
1PC
1PZA



RIPADO CENTRAL
MIDDLE SLAT
LISTÓN CENTRAL

2PCS
2PCS
2PZAS



FRENTE GAVETA
DRAWER FRONT
FRENTE DEL CAJÓN

1PC
1PC
1PZA



LATERAL GAVETA
DRAWER SIDE
LATERAL DEL CAJÓN

2PCS
2PCS
2PZAS



TRASEIRO GAVETA
DRAWER BACK
TRASERA DEL CAJÓN

1PC
1PC
1PZA



FUNDO GAVETA
DRAWER BOTTOM
FONDO DEL CAJÓN

1PC
1PC
1PZA

Passo 01 PARAFUSE AS PEÇAS 6 NAS PEÇAS 16 E 18 COM PARAFUSO 3,5x35 (F).

Step 01 ATTACH PARTS 6 TO PARTS 16 AND 18 WITH 3.5x35 SCREWS (F).

Paso 01 FIJE LAS PARTES 6 A LAS PARTES 16 Y 18 CON TORNILLOS 3,5x35 (F).

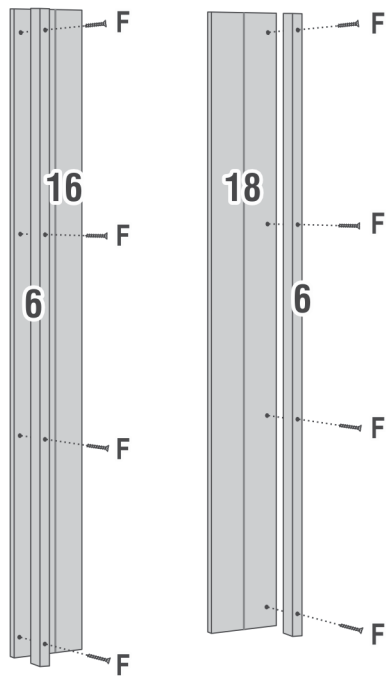

VISTA TRASEIRA
BACK VIEW
VISTA TRASERA



Passo 02 ENCAIXE AS PEÇAS 16, 17 E 18. EM SEGUIDA, ALINHE E PARAFUSE A PEÇA 11 COM PARAFUSO 4x25 (G), SEGUINDO AS LINHAS DEMONSTRATIVAS.

Step 02 PUT PARTS 16, 17, AND 18 TOGETHER. NEXT, BY FOLLOWING THE MARKS, ALIGN AND FASTEN PART 11 WITH 4x25 SCREWS (G).

Paso 02 UNA LAS PARTES 16, 17 Y 18. LUEGO, OBSERVANDO LAS MARCACIONES, ALINEE Y FIJE LA PARTE 11 CON TORNILLOS 4x25 (G).

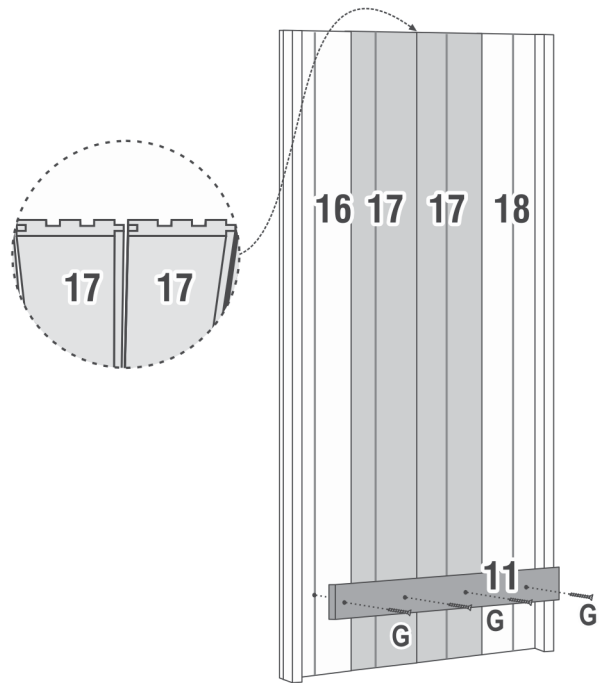

VISTA TRASEIRA
BACK VIEW
VISTA TRASERA



Passo 03 PASSE COLA NA PEÇA 13 E FIXE-A COM PARAFUSO 3,5x35 (F). EM SEGUIDA, COM A CABECEIRA DE PÉ, ALINHE A PEÇA 14 NA PEÇA 6 E PARAFUSE A PEÇA 14 COM CONECTOR 2 FUROS (D+H).

Step 03 APPLY GLUE TO PART 13 AND FASTEN IT WITH 3.5x35 SCREWS (F). NEXT, STAND THE HEADBOARD UPRIGHT, ALIGN PART 14 WITH PARTS 6, AND FASTEN PART 14 WITH 2-HOLE CORNER BRACKETS (D+H).

Paso 03 APLIQUE PEGAMENTO A LA PARTE 13 Y FÍJELA CON TORNILLOS 3,5x35 (F). COLOQUE LA CABECERA E PIE, ALINEE LA PARTE 14 CON LA PARTE 6, Y ATORNILLE LA PARTE 14 CON SOPORTES ANGULARES 2 AGUJEROS (D+H).

ATENÇÃO: ALINHE A PEÇA 14 COM A PEÇA 6 PARA PARAFUSAR.
NOTE: ALIGN PART 14 WITH PARTS 6 BEFORE FASTENING IT.
¡ATENCIÓN! ALINEE LA PARTE 14 CON LA PARTE 6 ANTES DE ATORNILLAR.

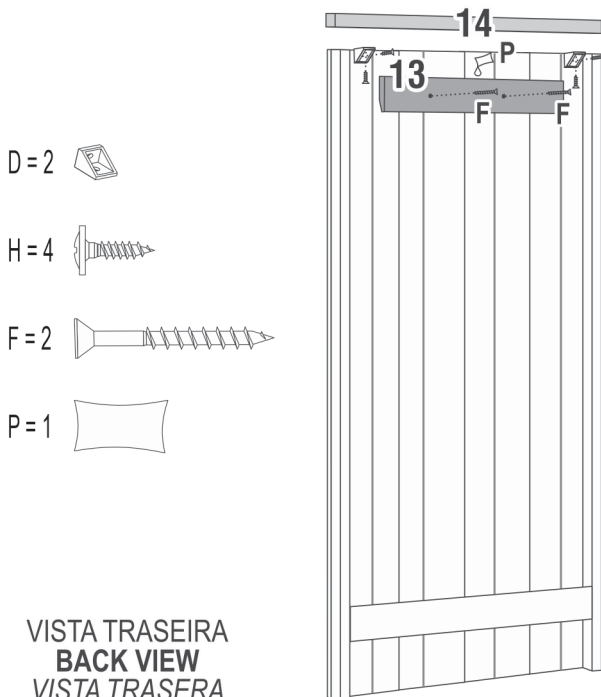

D = 2 

H = 4 

F = 2 

P = 1 

VISTA TRASEIRA
BACK VIEW
VISTA TRASERA

Passo 04 INSTALE A CORREDEIRA NAS PEÇAS 22 E 23 COM PARAFUSO 3,5x14 (E). ENCAIXE AS PEÇAS 22 E 23 NA PEÇA 24 COM MINIFIX (K+Q). EM SEGUIDA, PARAFUSE A PEÇA 21 NAS PEÇAS 22 E 23 COM PARAFUSO 5x40 (J).

Step 04 FASTEN THE SLIDES TO PARTS 22 AND 23 WITH 3.5x14 SCREWS (E). ATTACH PARTS 22 AND 23 TO PART 24 WITH MINIFIX (K+Q). NEXT, FASTEN PART 21 TO PARTS 22 AND 23 WITH 5x40 SCREWS (J).

Paso 04 FIJE LAS CORREDERAS A LAS PARTES 22 Y 23 CON TORNILLOS 3,5x14 (E). FIJE LAS PARTES 22 Y 23 A LA PARTE 24 CON MINIFIX (K+Q). LUEGO, FIJE LA PARTE 21 A LAS PARTES 22 Y 23 CON TORNILLOS 5x40 (J).

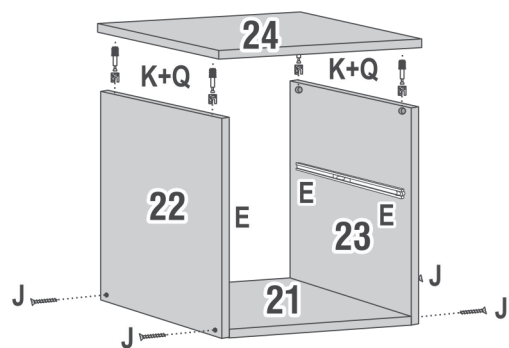

E = 4 

J = 4 

K = 4 

Q = 4 

Passo 05 PARAFUSE O NICHU MONTADO (PEÇAS 21 E 24) NAS PEÇAS 17 DO RIPADO COM PARAFUSO 5x40 (J), SEGUINDO AS LINHAS DEMONSTRATIVAS.
Step 05 FOLLOW THE MARKS TO ATTACH THE NIGHTSTAND (PARTS 21 AND 24) TO THE SLATTED PANELS (17) WITH 5x40 SCREWS (J).
 Paso 05 OBSERVE LAS MARCACIONES PARA ATORNILLAR LA MESA DE NOCHE (PARTES 21 Y 24) A LOS LISTONES DE LOS PANELES (17) CON TORNILLOS 5x40 (J).

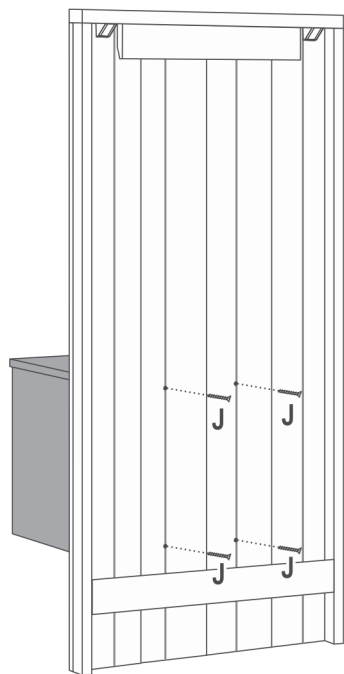

VISTA TRASEIRA
BACK VIEW
 VISTA TRASERA

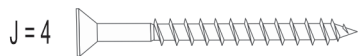

Passo 06 MONTE A GAVETA CONFORME O DESENHO COM AS RESPECTIVAS FERRAGENS.
Step 06 ASSEMBLE THE DRAWER WITH ITS HARDWARE ACCORDING TO THE DRAWING.
 Paso 06 MONTE EL CAJÓN CON SUS HERRAJES SEGÚN EL DIBUJO.

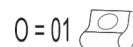
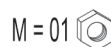
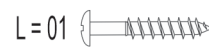
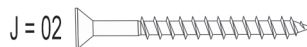
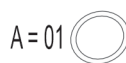
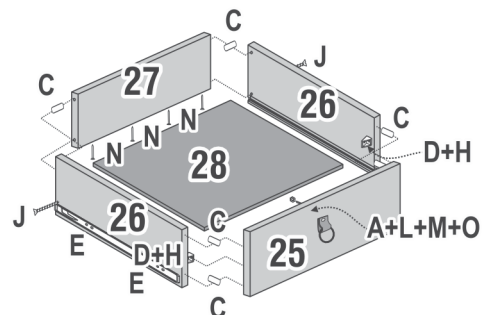

Passo 07 PARAFUSE A PEÇA 12 NA PAREDE COM PARAFUSO 7x60 (I) E BUCHA (B).
Step 07 SCREW PART 12 TO THE WALL WITH 7x60 SCREWS (I) AND DRYWALL ANCHORS (B).
 Paso 07 ATORNILLE LA PARTE 12 A LA PARED CON TORNILLOS 7x60 (I) Y TACOS PARA YESO (B).

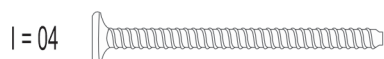
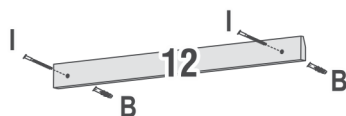

Passo 08 INSTALE O MÓDULO JÁ MONTADO NA PAREDE, POR MEIO DA PEÇA 12, AJUSTANDO-A PARA QUE O MÓDULO MESA DE CABECEIRA FIQUE ALINHADO COM A CABECEIRA SONHAR, CONFORME DESENHO A BAIXO.

Step 08 AS THE DRAWING SHOWS, ALIGN THE HEADBOARD WITH THE WALL MOUNT (12), SO THAT THE NIGHTSTAND UNIT REMAINS ALIGNED WITH SONHAR HEADBOARD.

Paso 08 SEGÚN EL DIBUJO ABAJO, ALINEE EL PANEL YA ARMADO CON LA PARTE 12, DE MODO QUE EL MÓDULO DE LA MESA DE NOCHE QUEDE ALINEADO CON LA CABECERA SONHAR.

