

# MANUAL DE MONTAGEM

BALCAO 1P. 700X790X520

Ref.120RBTR

Informe este código  
para reposição de peças.







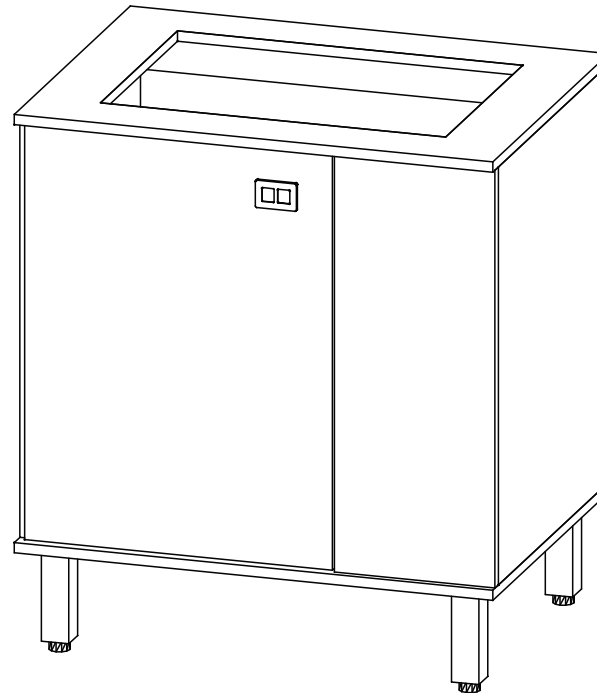



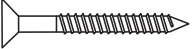
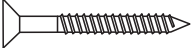

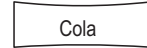
## Relação de peças:

CMP06308	1	LATERAL ESQUERDA	540	380	15	1
CMP06309	2	LATERAL DIREITA	540	380	15	1
CMP06310	3	BASE	665	400	15	1
CMP06311	4	TAMPO	665	420	15	1
CMP06312	5	PRATELEIRA	635	200	15	1
CMP06313	6	LATERAL SUPERIOR	380	325	15	2
CMP06314	7	TETO	665	380	15	1
CMP06315	8	PORTA	425	535	15	1
CMP06316	9	FECHAMENTO	235	540	15	1
CMP06317	10	FUNDO	660	282	3	2
CMP06318	11	FUNDO	660	100	3	1

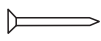

## Relação de ferragens:

- A.  4,0X40 - 04 x
- B.  4,0X25 - 02 x
- C.  4,0x14 - 20 x
- D.  6x30 - 20 x
- E.  Cola - 01 x
- F.  - 06 x
- G.  Caneco 26 reta calço 5 - 02 x
- H.  Garrinha fix. fundo - 04 X
- I.  10x10 - 27 x
- J.  Suporte pino - 01x
- L.  Pé PVC - 04 X
- M.  Puxador - 01 X

OBS: Usar Cola (E) na Cavilha (D)

● Usar cantoneira (F) e parafuso (C) para fixação da parte superior.

