

MANUAL DE MONTAGEM



GUARDA ROUPA

ALICE

RELAÇÃO DE FERRAGENS EM TAMANHO REAL (MEDIDA EM MILÍMETRO).



A - PARAF. 3,5x14



B - PARAF. 5x40 SEM PONTA



C - PARAF. 4,0x25

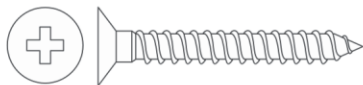

D - PARAF. 4,0x35

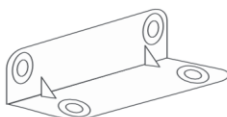

E - CANTONEIRA 4 FUROS



F - SACHÊ DE COLÇA

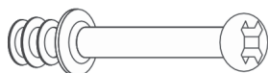

G - MINIFIX SIMPLES

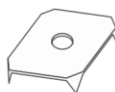

H - FIXADOR DE COSTAS



I - TAMBOR MINIFIX



J - TAMPA ADESIVA

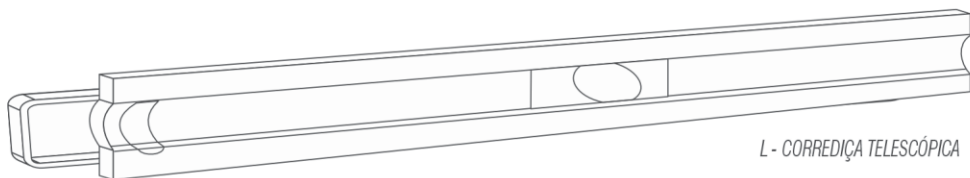

L - CORREDIÇA TELESCÓPICA



M - PUXADOR



N - CANTONEIRA 4 FUROS

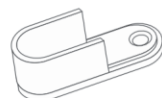

O - SUPORTE CABIDEIRO



P - CABIDEIRO



Q - CAVILHA 6x30



R - PREGO 10x10

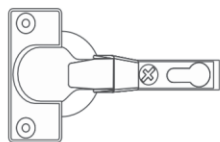

T - DOBRADIÇA

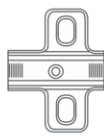

U - CALÇO



V - PARAF. 3,5x20 FLANGEADO

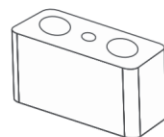



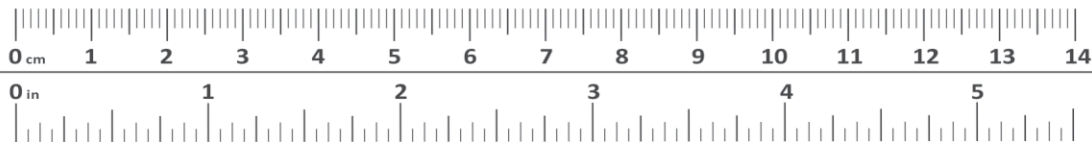

W - ALONGADOR DE CORREDIÇA



FAVOR IDENTIFICAR AS PEÇAS E COLOCAR SEUS RESPECTIVOS ACESSÓRIOS

Sequência de Montagem





- 01 - Parafusar peças 1 na peça 2.
- 02 - Parafusar peças 3 nos rodapés 2
Observação: Seguir a furação que vai em cima do rodapé 2 para colocação do rodapé 03 tem que ficar alinhado.
- 03 - Parafusar peça 4 nas peças 2;
- 04 - Parafusar os Pés 5 nos rodapés 2.

- A**  Paraf. 3,5x14
- B**  Paraf. 5x40 s/ Ponta
- C**  Paraf. 4x25
- E**  Cant. 4 Furos



Sequência de Montagem

- 05 - Encaixar e Parafuse peça 6 nos rodapés 2 e laterais 1 e 4;
- 06 - Encaixar e parafusar peças 7 na peça 6;
- 07 - Parafusar peças 8 nas peças 7 e 4;
- 08 - Encaixar peça 9 nas peças 1 e 7.

- B**  Paraf. 5x40 s/ Ponta
- G**  Minifix Simples
- I**  Tambor
- J**  Tampinha
- Q**  Cavilha 6x30

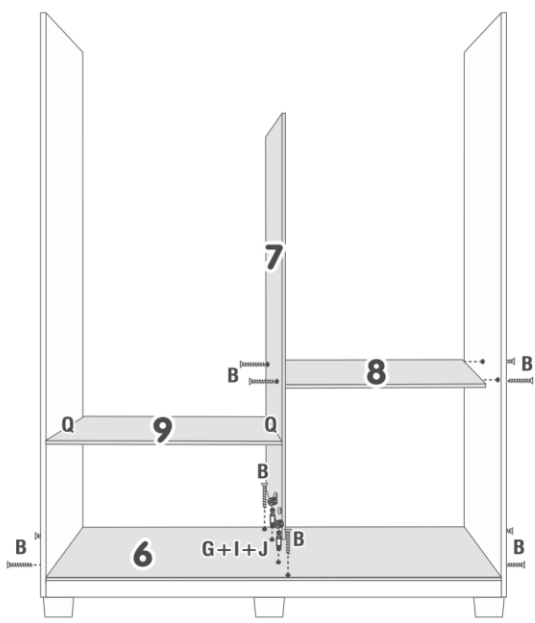

Sequência de Montagem

- 09 - Parafusar a peça 10 nas peças 1 e 7;
- 10 - Parafusar a peça 13 nas peças 1 e 4 em seguida parafusá-la na peça 7;
- 11 - Parafusar peça 11 nas peças 10 e 13;
- 12 - Fixar as Peças 12 nas peças 1, 7 e 11.

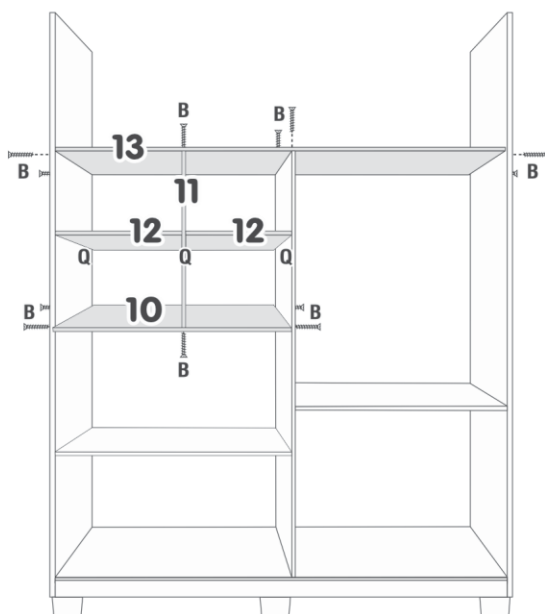
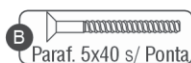

Sequência de Montagem

- 13 - Fixar e parafusar peças 14 na peça 13.
- 14 - Encaixar e parafusar peça 15 na peças 01 e 04 e depois parafusá-la nas peças 14.

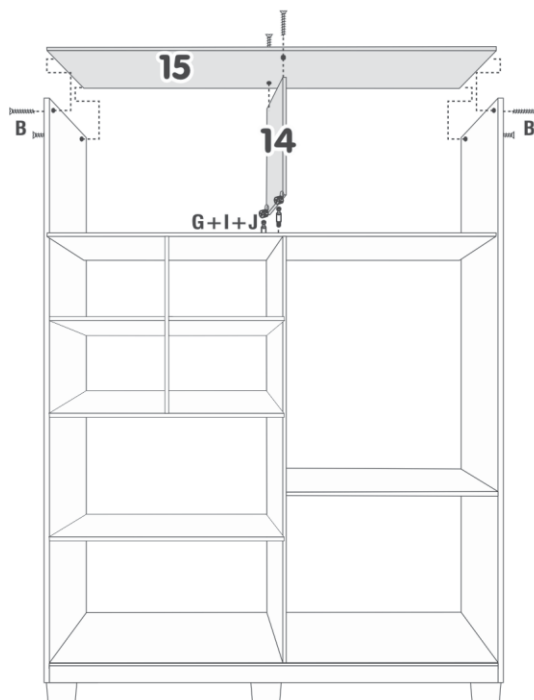
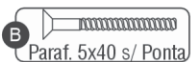

Seqüência de Montagem

- 15 - Fixar peças 16 nas peças 01, 04 e também na peça 15.
- 16 - Parafusar Alongador de correção conforme desenho.

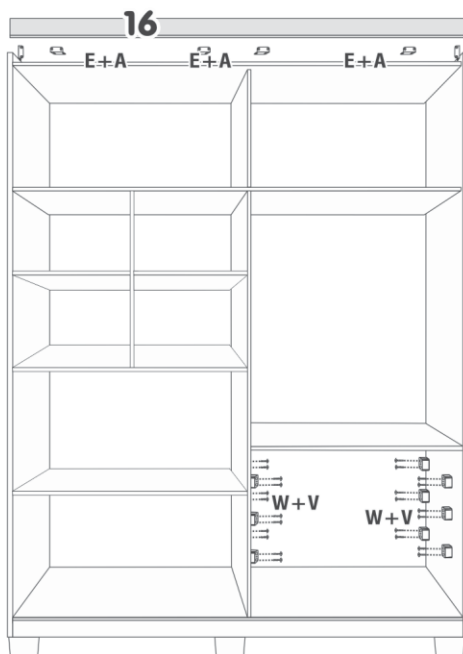

Seqüência de Montagem

- 17 - Montar os cabideiros com os suportes.
- 18 - Parafusar as correções.

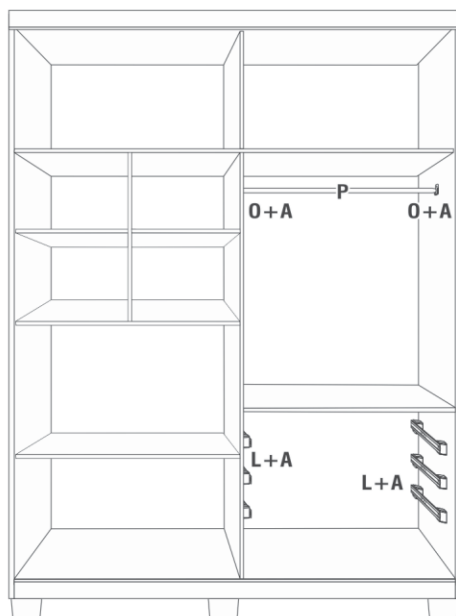

Sequência de Montagem

19 - Pregiar as Costas 22 conforme desenho ao lado.

OBS.: Acertar as costas para melhor esquadramento do móvel.

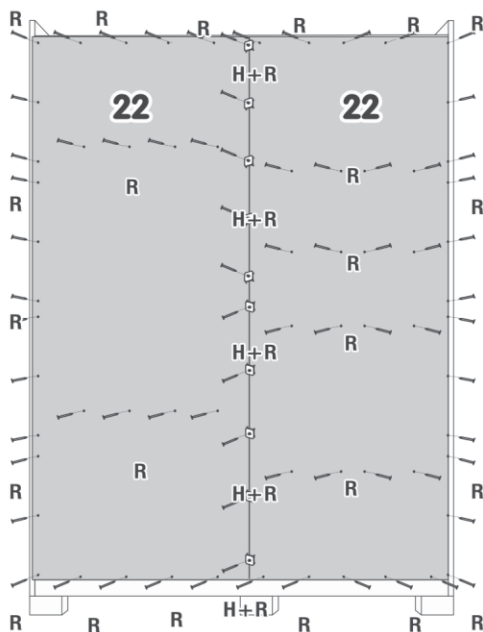
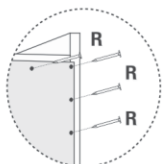

Sequência de Montagem

20 - Montar e fixar as Portas 24.

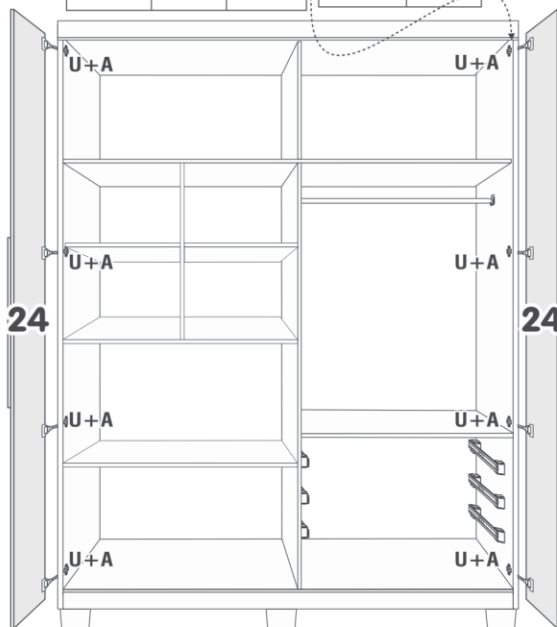
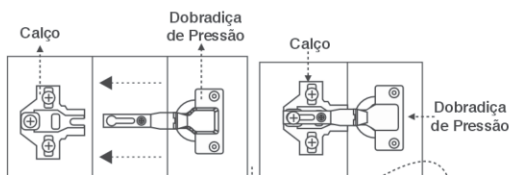
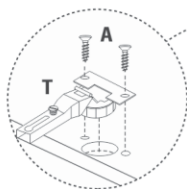

Sequência de Montagem

- 20 - Parafusar as cantoneiras nas peças 19;
- 21 - Parafusar as peças 19 na peça 18 colocando cola nas cavilhas;
- 22 - Parafusar a peça 20 nas peças 19;
- 23 - Parafusar peça 21 nas peças 19 e 20 conforme desenho abaixo, ajustando para melhor esquadrejamento da gaveta;
- 24 - Parafusar as corredeiras na lateral da peça 19;

