

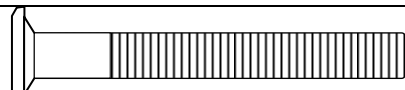

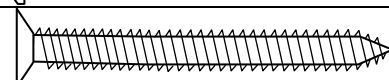

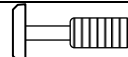

CÓD	DESENHO	QTD	NOME (ONDE USAR)
A		3	PARAFUSO ¼" X 50
B		10	PARAFUSO 4,5 X 50
C		14	PARAFUSO GIROFIX
D		14	PORCA GIROFIX
E		32	CAVILHA 6 X 30
F		2	PAR DE CORREDIÇA
G		6	TAMPINHA CPL
I		14	PARAFUSO 4 X 25
J		18	PARAFUSO 4 X 14
K		20	PREGO 8 X 8 – FIXAR FUNDO
L		4	PONTEIRA INTERNA - 7/8"
M		1	PARAFUSO 4 X 30 - FIXA TRAVA NA PRATELEIRA
N		2	PUXADOR PARA GAVETA
O		2	PARAFUSO 3/16" X 5/8" – PARA GAVETA
P		1	ASTE ROSCADA ¼" X 55 mm

COD. PEÇA	QTD	DESCRIÇÃO DE PEÇAS	
1	1	TAMPO INFERIOR	MDP 1200X430X15mm
2	1	TAMPO CENTRAL	MDP 1200X430X15mm
3	1	TAMPO SUPERIOR	MDP 878X430X15mm
4	1	TAMPO DA PRATELEIRA	MDP 307X430X15mm
5	1	DIVISÓRIA CENTRAL	MDP 210X430X20mm
6	1	LATERAL ESQUERDA	MDP 210X430X15mm
7	1	LATERAL DA PRATELEIRA	MDP 600X430X15mm
8	1	FUNDO TRASEIRO	MDF 870X230X2,8mm
9	1	ARMAÇÃO ESQUERDA	TUBO 1855X470X20mm
10	1	ARMAÇÃO DIREITRA	TUBO 1855X470X20mm
11	1	CABIDEIRO	TUBO 17X1163mm
12	1	SUPORTE GAVETEIRO	TUBO 19X330mm
13	2	LATERAL ESQUERDA DE GAVETA	MDP 380X120X15mm
14	2	LATERAL DIREITA DE GAVETA	MDP 380X120X15mm
15	2	FUNDO DE GAVETA	MDF 395X515X2,8mm
16	2	FRETE DE GAVETA	MDP 200X550X15mm
17	2	CONTRA FUNDO GAVETA	MDP 530X1200X15mm
18	1	PÉ	MDF 115 X 60 X 60mm

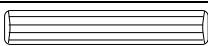
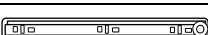
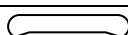
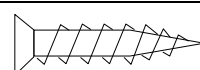
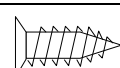
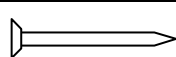
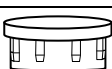
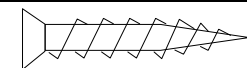

PRODUTO MONTADO: 1860x1200x470 mm

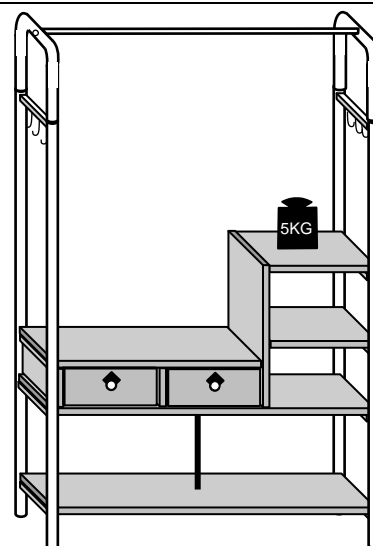

2 PESSOA

## MONTANDO PASSO A PASSO

**ATENÇÃO SR. MONTADOR:** PARA EVITAR AVARIAS AO PRODUTO QUANDO MONTADOS COM PARAFUSADEIRAS O MESMO DEVERÁ SER MONTADO COM TORQUE BAIXO.

 PARAFUSO 4.5 X 50 CÓD: B QTD: 6	 TAMBOR MINIFIX CÓD: D QTD: 6	 CAVILHA 6 X 30 CÓD: E QTD: 16
 PARAFUSO MINIFIX CÓD: C QTD: 10	 PAR CORREDIÇA 400mm CÓD: F QTD: 2	 PARAFUSO 4.0 X 14 CÓD: J QTD: 4

**1º PASSO:** COLOCAR AS CORREDIÇAS NAS LATERAIS DO CLOSET E FIXAR A BASE E TAMPOS.

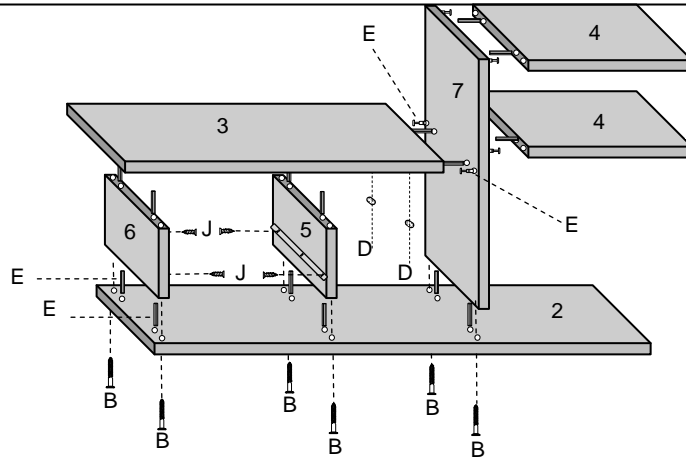

 PARAFUSO 1/2" X 50 CÓD: A QTD: 3	 PREGO 8 X 8 CÓD: K QTD: 20	 TAMPINHA CPL CÓD: G QTD: 2
 PARAFUSO 4.0 X 25 CÓD: I QTD: 14	 ASTE ROSCADA 1/4" X 55 CÓD: P QTD: 1	

**2º PASSO:** FIXAR A AMAÇÃO E PREGAR O FUNDO

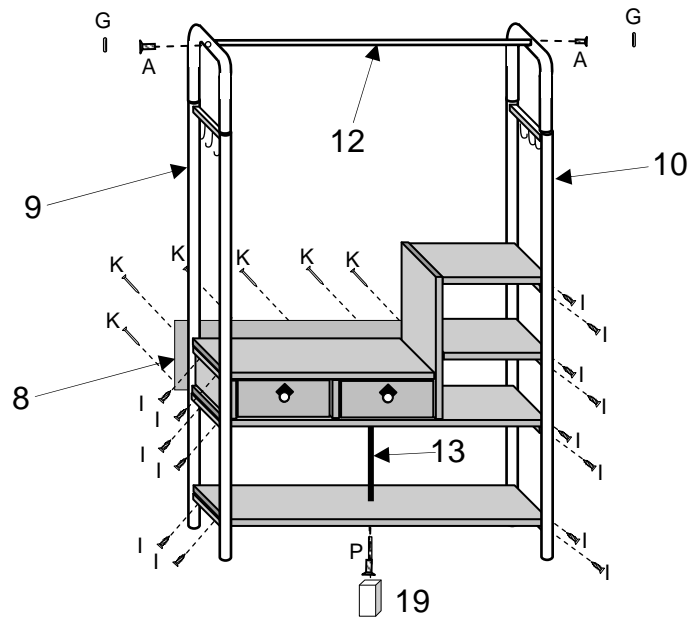

**3º PASSO:** MONTAGEM DA GAVETA

 PARAFUSO 4.5 X 50 CÓD: B QTD: 4	 TAMBOR GIROFIX CÓD: D QTD: 2	 CAVILHA 6 X 30 CÓD: E QTD: 16
 PARAFUSO MINIFIX CÓD: C QTD: 2	 PAR CORREDIÇA 400mm CÓD: B QTD: 2	 PARAFUSO 4.0 X 14 CÓD: J QTD: 4

