

Para Limpeza de seu Móvel: Use uma Flanela seca ou umedecida / Não use produto Químico que pode danificar seu móvel.

For Cleanness of its Furniture: It uses a dry or umedecida Flannel / It does not use Chemical product that can damage its furniture.







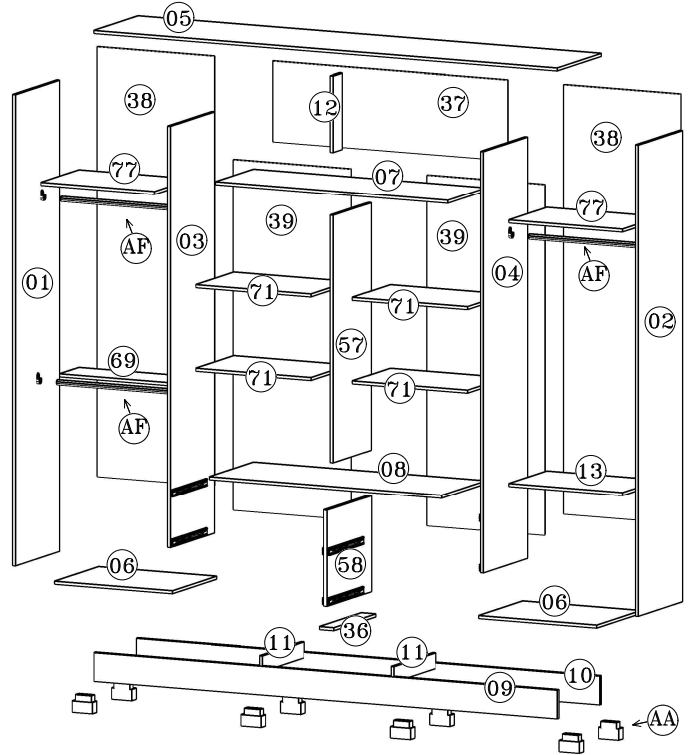
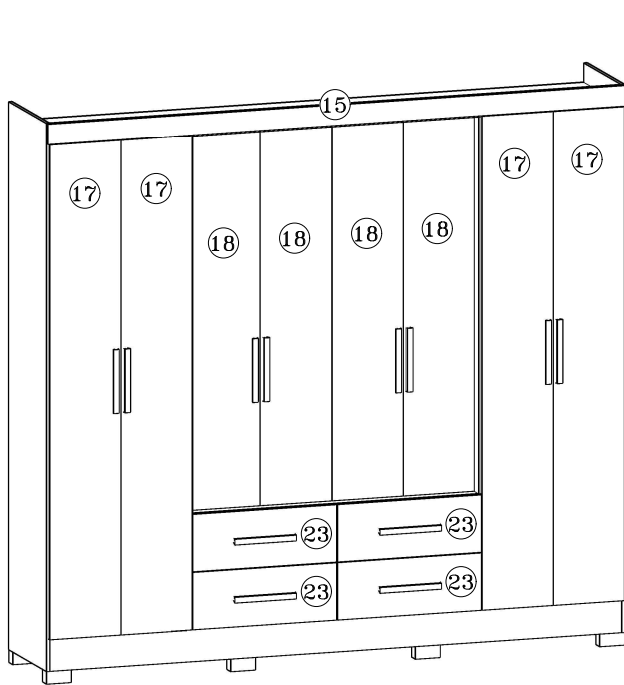



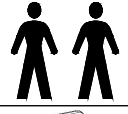
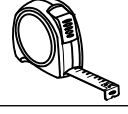
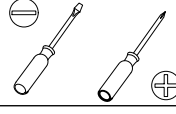

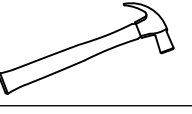



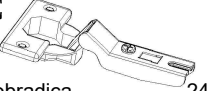



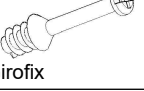





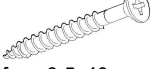



Limpieza del mobiliario: Utilice una flanela seca o húmeda / No use productos químicos que pueden dañar el mobiliario.

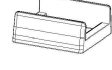

Indústria Brasileira - Made in Brazil 08/20 640.20.9413



<i>Elaboração:</i> Daniel Santos	<i>Aprovação:</i> Adauto Bisoto	<i>Versão:</i> 01	<i>Revisão:</i> 19/08/2020
-------------------------------------	------------------------------------	----------------------	-------------------------------

 120 min					
 Cavilha 6x30 24	 Cantoneira L 3 furos 09	 Fixador Reto 52	 Paraf. 4,0x12 Panela 84	 Dobradiça 24	 Calço 12mm 06
 Calço 07mm 18	 Castanha Girofix 02	 Pino Girofix 02	 Porca sextavada 06	 Parafuso 4,0x50 50	 Parafuso 4,0x35 04
 Par. 3,5x25 Flang. 24	 Parafuso M 4x22 06	 Paraf. Flang. 4,0x12 24	 Parafuso 3,5x40 24	 Parafuso 3,5x12 79	 Prego 10x10 173
 Puxador MDF 12	 Apoio Oval 06	 Buchta Cilindrica 34	 Sapata U 10	 Pé Plástico 08	 Suporte prateleira 20
 Tapa furo ades. 06	 Bisnaga de Cola 02	 Etiqueta Lit 01	 Bastão 03	 Suporte prat. 08	 Corrediça 04

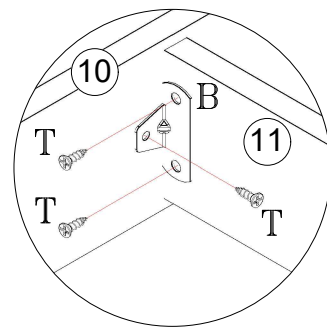
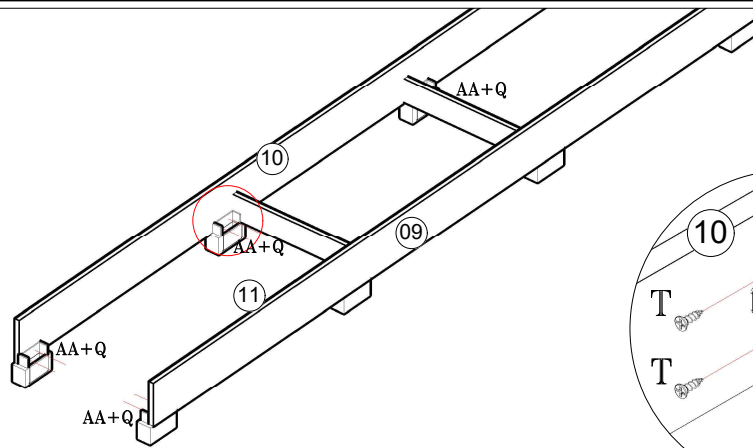
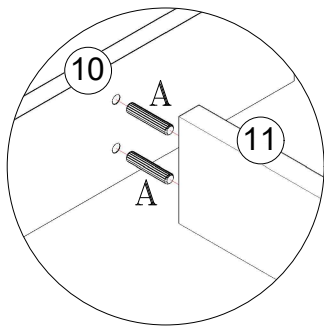

01

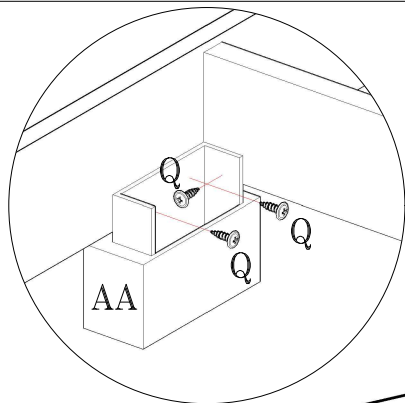

03 e 04

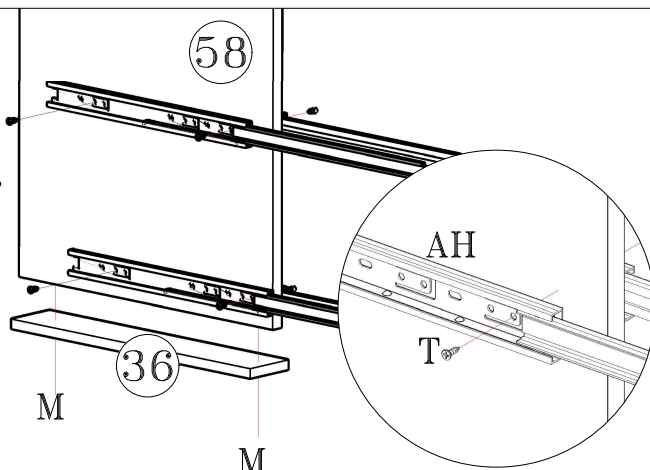
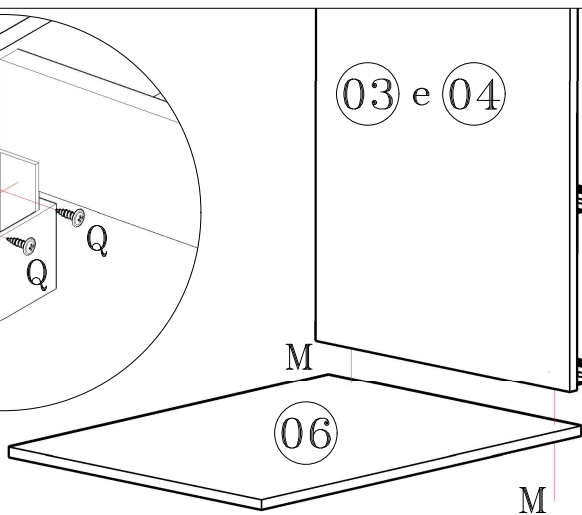

02

Indústria Brasileira - Made in Brazil 08/20 640.20.9413

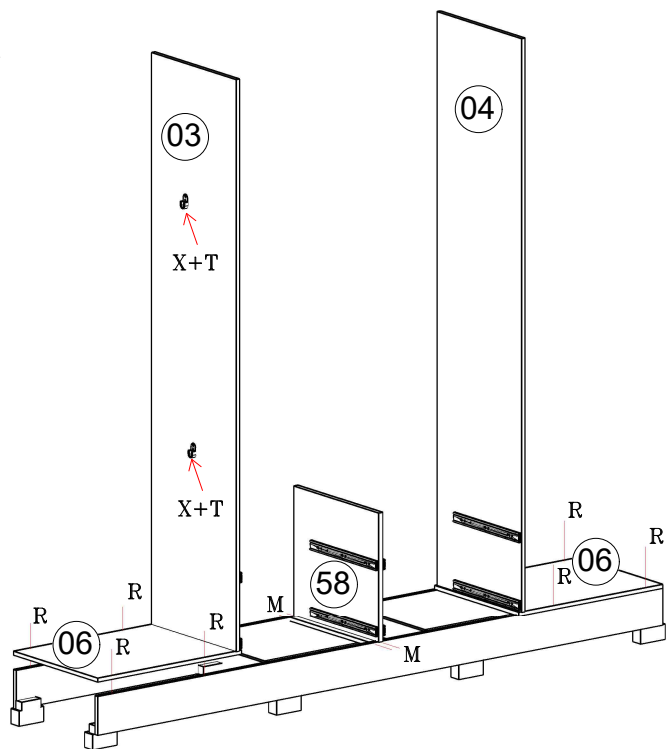

03

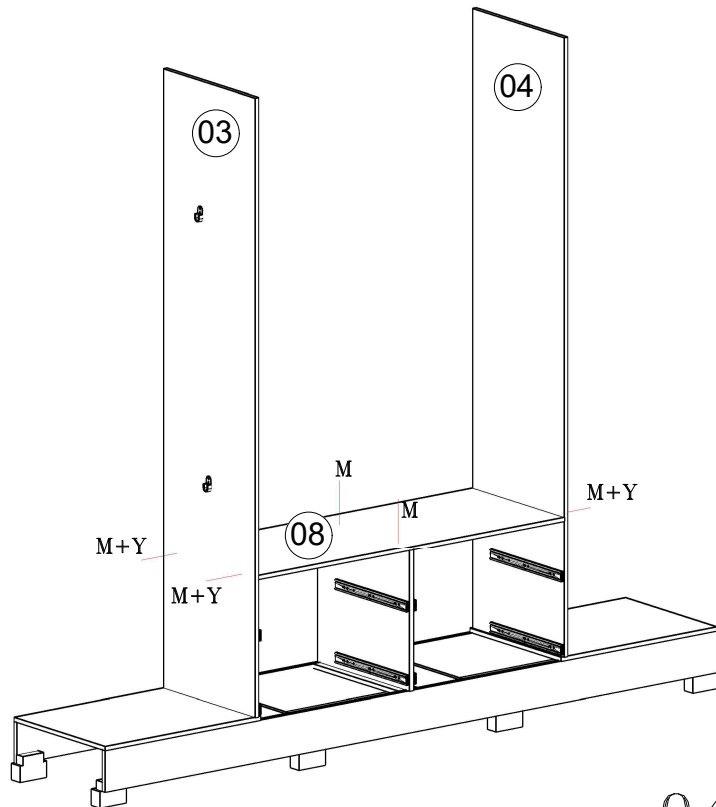

04

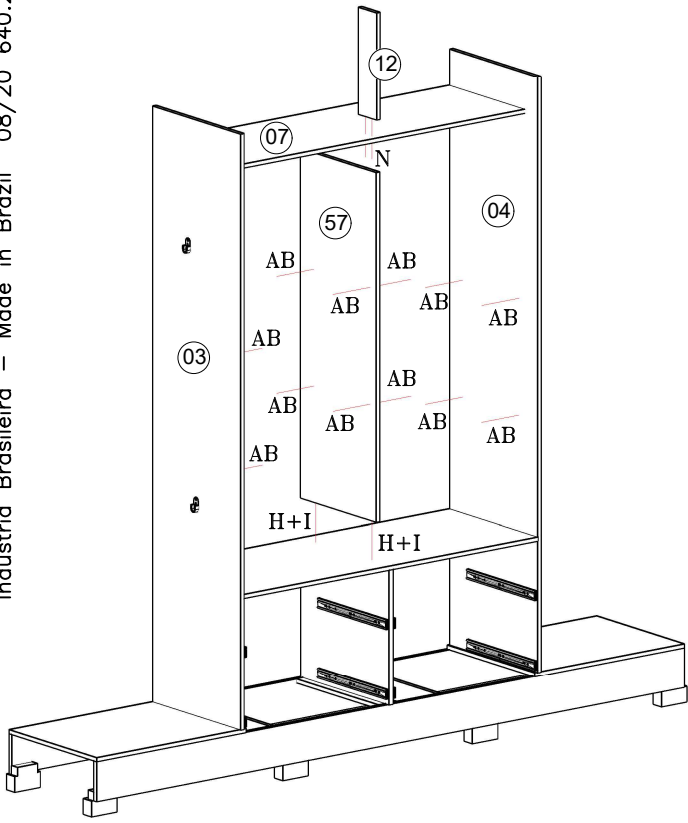

05

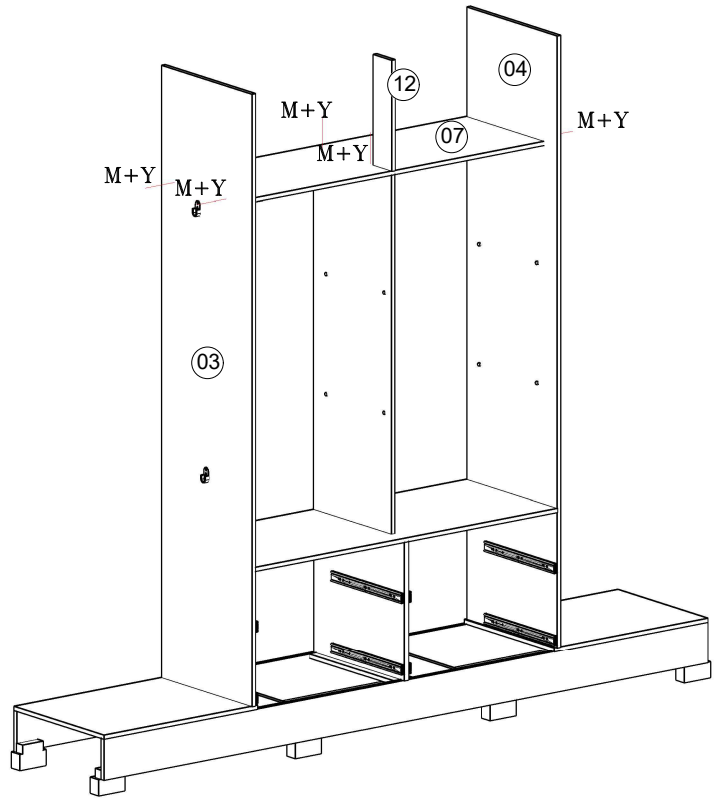

06

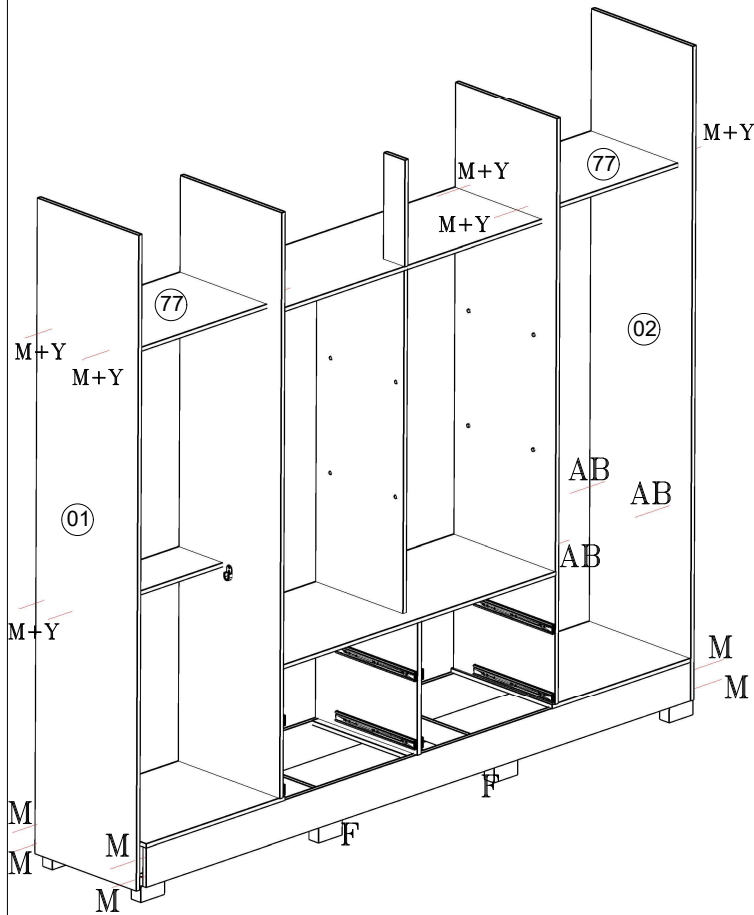

07

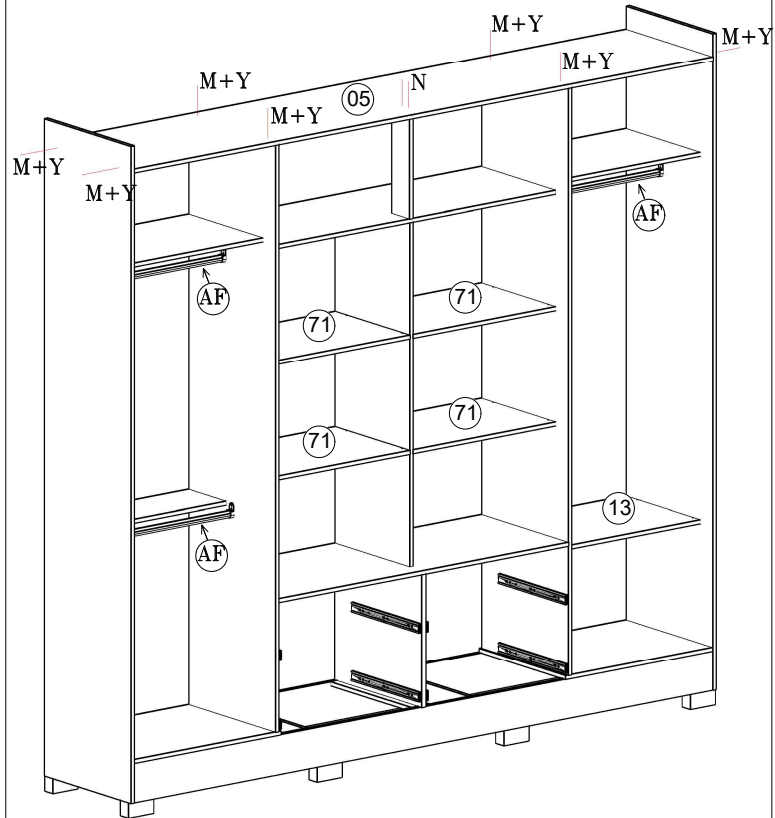

08

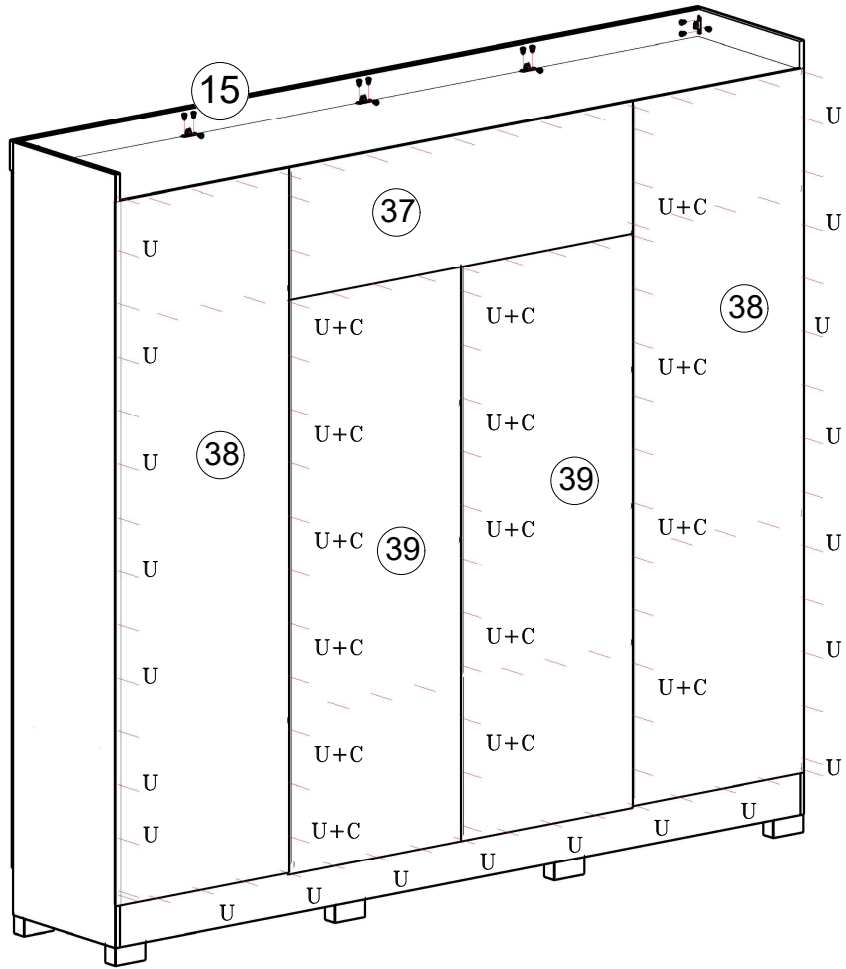
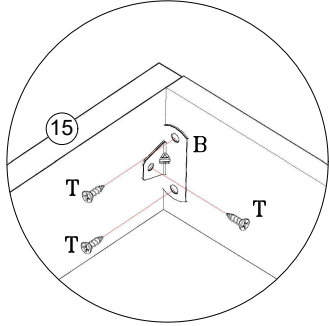

09

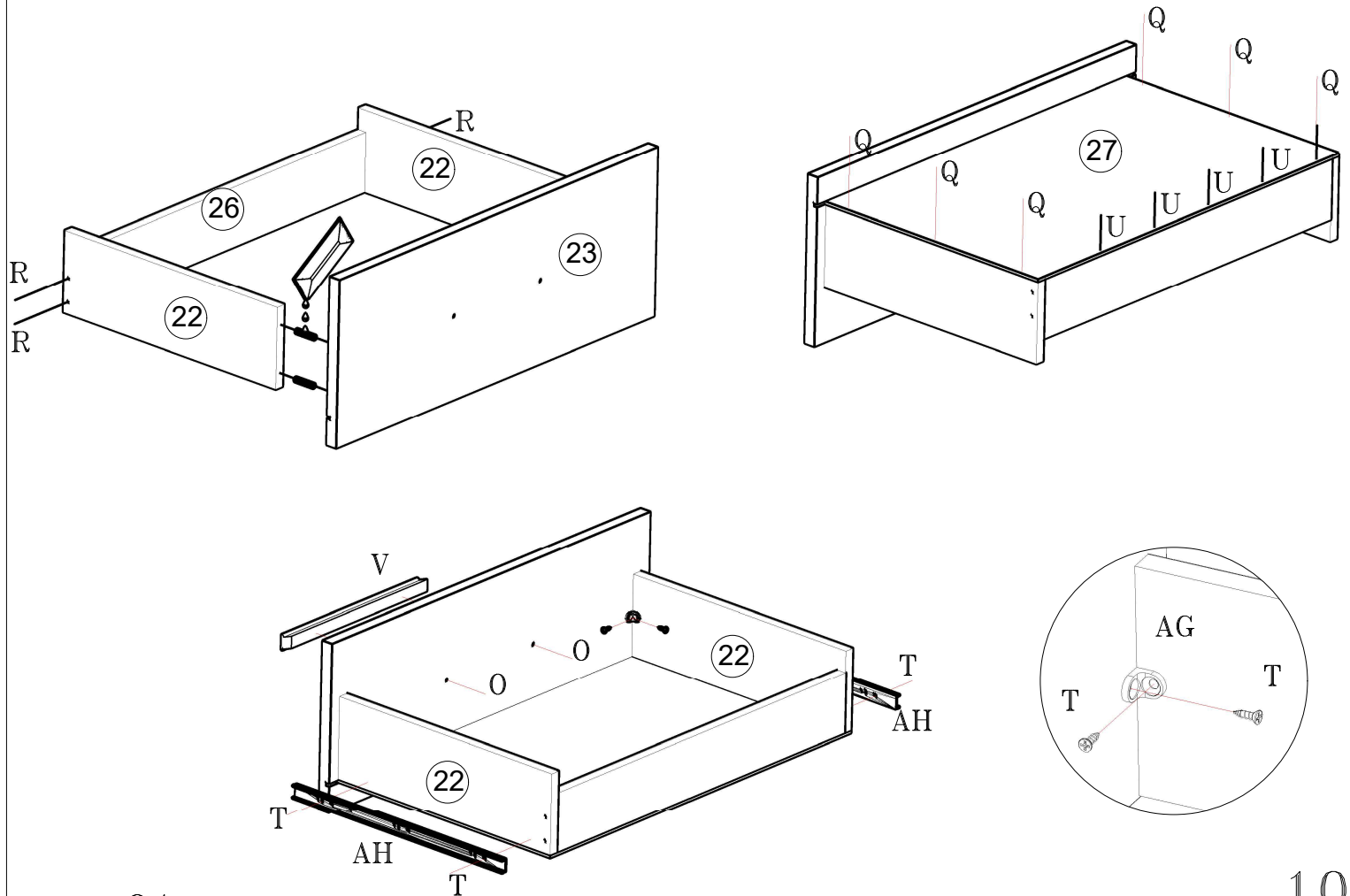

10

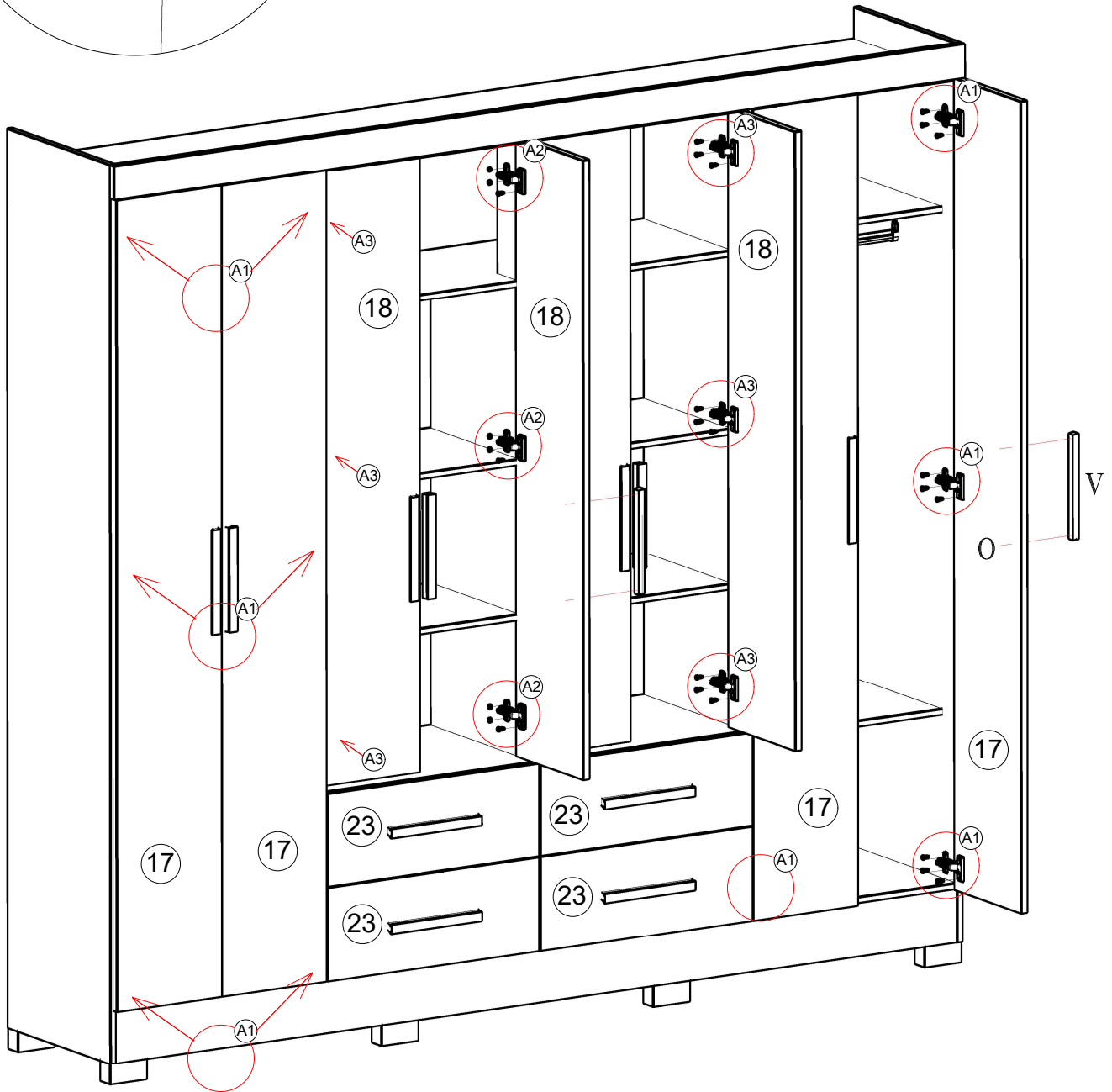
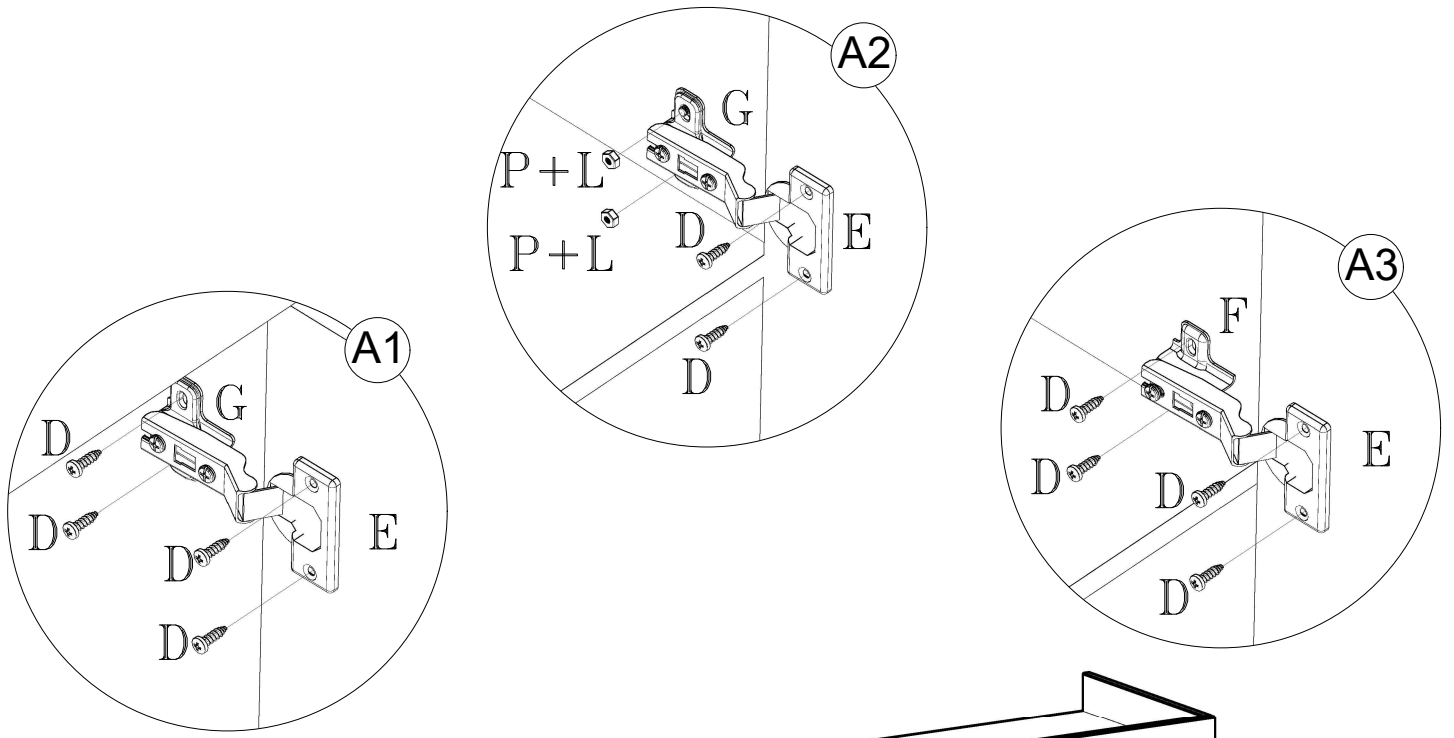

DESCRIÇÃO DESCRIPTION	QT. AMOUNT	ITEM PART	COMP. MM	LARG. MM
Lateral esquerda/Lateral Izquierda/Left Side	01	01	2170	448
Lateral Direita/Lateral Derecha/Right Side	01	02	2170	448
Divisória Esquerda/División Izquierda/Left Division	01	03	1940	448
Divisória Direita/División Derecha/Right Division	01	04	1940	448
Quadro Chapéu/Cuadro Techo/Hat Square	01	05	2346	448
Quadro Base/Cuadro Base/Base Square	02	06	595	448
Quadro Central/Cuadro Central/Square Central	01	07	1174	384
Quadro Interno/Cuadro Interno/Square Internal	01	08	1174	448
Rodapé Frontal/Zocalo Frontal /Front Baseboard	01	09	2346	130
Rodapé Traseiro/Zocalo Trasero/Back Baseboard	01	10	2346	130
Trava de Rodapé/Traba del Zocalo/Constraint Baseboard	02	11	415	70
Batente/Batiente/Windowsill	01	12	350	90
Prateleira móvel / Estante movil / mobili shelf	01	13	574	384
Encabeçamento/Techo/Header	01	15	2367	80
Porta Inteira/Puerta Larga/Biggest Door	04	17	1960	290
Porta Menor/Puerta Corta/Smaller Door	04	18	1488	290
Lateral da Gaveta/Lateral De La Cajonera/Side Drawer	08	22	350	109
Frente de Gaveta/Frente De La Cajonera/Front Drawer	04	23	588	225
Traseiro de Gaveta/Trasero Del Cajon/Back Drawer	04	26	532	105
Fundo de Gaveta/Fondo Del Cajon/Bottom Drawer	04	27	555	355
Trava da Divisória/Traba De La División/Constraint Division	01	36	415	70
Traseiro de Maleiro/Trasero Del Malero/Back Luggages	01	37	1186	368
Traseiro de Armário/Trasero Del Ropero/Back Closet	02	38	1976	590
Traseiro Central de Armário/Trasero Central Del Ropero/Back Central Closet	02	39	1613	593
Divisória Central/División Central/Central Division	01	57	1135	384
Divisória do Gaveteiro/División De La Cajonera/Drawer Division	01	58	443	448
Prateleira Menor/Estante Corta/Lesser Shelf	01	69	574	192
Prateleira Central/Estante Central/Central Shelf	04	71	581	384
Quadro Central Lateral/Cuadro Central Lateral/Side Central Square	02	77	574	384