



PRATELEIRA MULT-USO COLEÇÃO KITCUBOS CAM001 CAMA CASINHA HELENA

FERRAMENTAS



Descrição	Quantidade
-----------	------------

CAB	Cabeceira	1
PES	Peseira	1
LAT	Laterais	2
EST	Estrado	1
SMA	Suporte Maior	2
SME	Suporte Menor	3
SUT	Suporte Telhado	2
ACT	Acabamento Telha	2
TMA	Telhado Maior	1
TME	Telhado Menor	1
COR	Coração	1
BAR	Base revesteiro	1
LAR	Laterais revesteiro	2
TRR	Trava revesteiro	1

Descrição

Quantidade

TAFU.001 - Tapa Furo
(13mm)

30



PAFX.010 - Parafuso Estrutural 5X50
(Para: A estrutura, suporte estrado e revisteiro)

18



PAFX.004 - Parafuso 4,0x30mm
(Para: o Telhado)

12



PAFF.002 - Parafuso 3,5x25mm
(Para: O Suporte telhado)

6



PAFF.001 - Parafuso 3,5x14mm
(Para: cantoneira)

4



CANT.002 - Parafuso 3,5x14mm
(Para: cantoneira)

2



Passo a passo

- 1 - Verifique se o produto encontra-se com todos os acessórios e ferragens.
- 2 - Proteja a superfície onde o produto será montado, afim de evitar danos.
- 3 - Una as laterais com a peseira e cabeceira, com o auxílio de uma chave, fixando os parafusos.
- 4 - Fixe os suportes para o Telhado parafusando de dentro para fora.
- 5 - Na sequência una a estrutura do suporte do estrado e encaixe dentro da cama.
- 6 - Apoie o estrado sobre o suporte
- 7 - Fixe os acabamentos do telhado, começando pelo menor e parafusando por cima o maior.
- 8 - Fixe o telhado menor, na sequência o maior
- 9 - Centralize o e cole coração e posicione o revisteiro e fixe com as cantoneiras.
- 10 - Cole os tapa furos para melhor acabamento do móvel.

Passo a passo

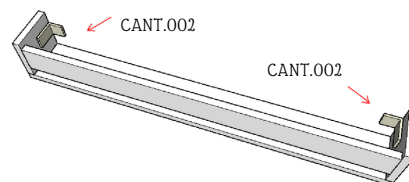
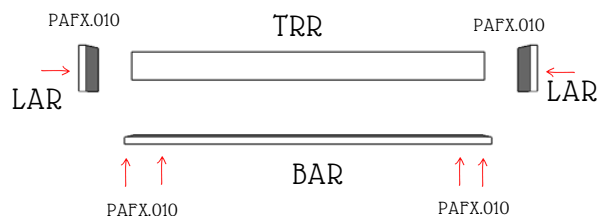
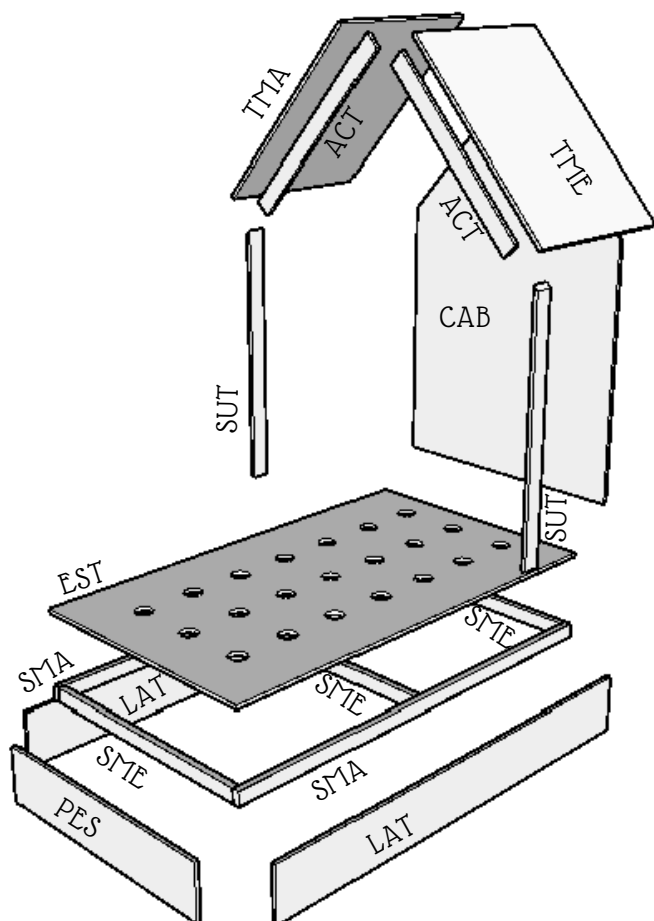



PRATELEIRA MULT-USO COLEÇÃO KITCUBOS CAM001 CAMA CASINHA HELENA



Passo a passo

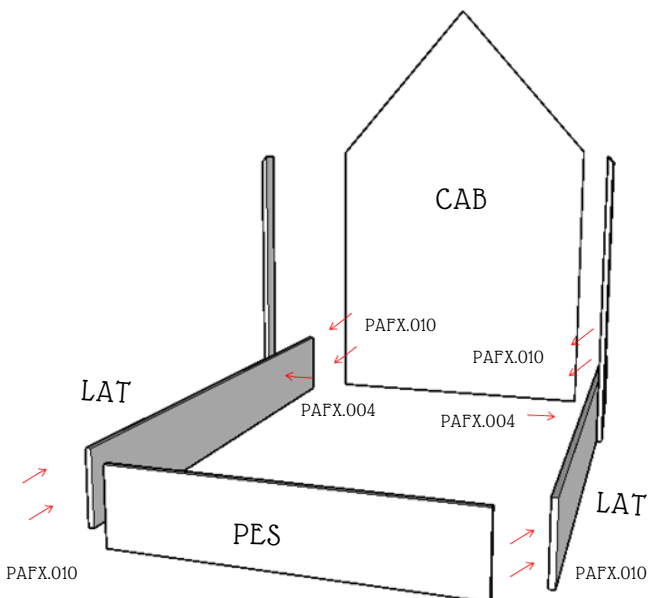

Passo a passo

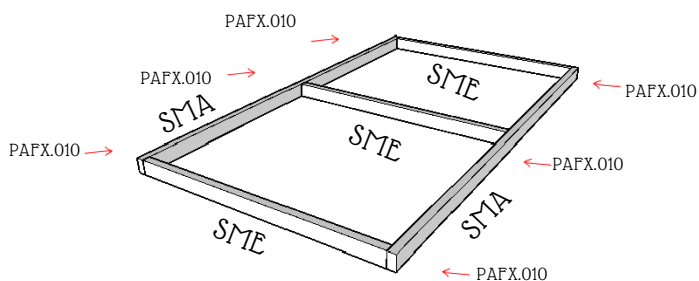

Passo a passo

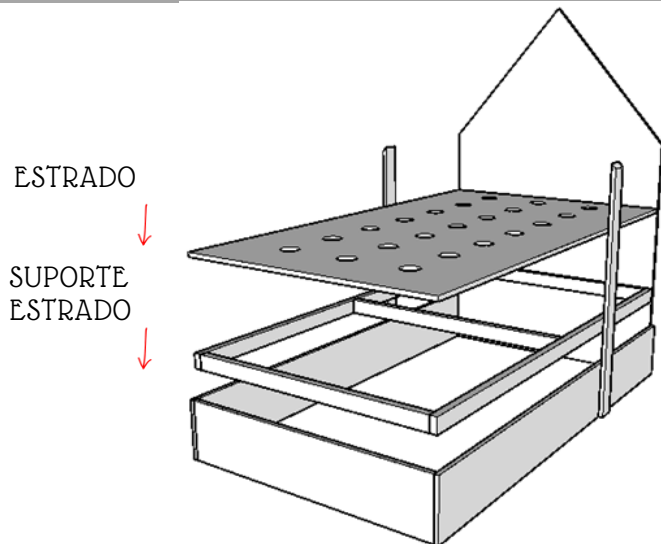

Passo a passo

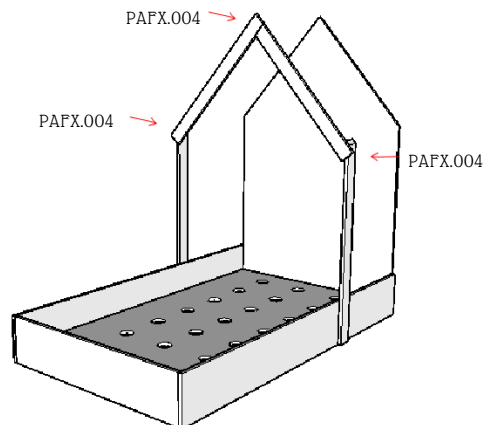

Passo a passo

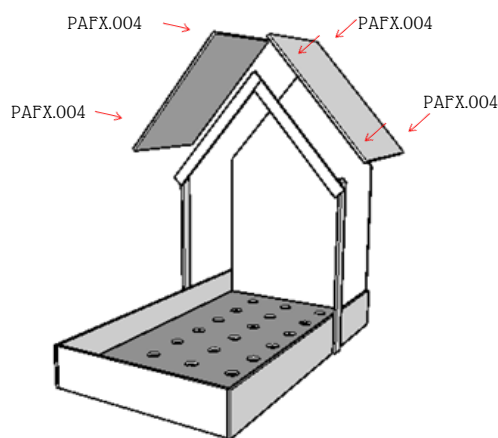

Passo a passo

