

# MANUAL DE INSTRUÇÕES

---

## Base

### PARA OMBRELONE CENTRAL



# RECOMENDAÇÕES







Base para ser utilizada em ombrelones centrais de até 300 cm de diâmetro, adequada para poste de  $\Phi 38/48$ .

Após cheia d'água: 22 kgs

Manter o ombrelone fechado quando não estiver sendo utilizado.

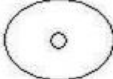
Em caso de chuva ou vento forte fechar o guarda-sol imediatamente.

## COMPONENTES

<p><b>A</b></p>  <p>x1</p>	<p><b>D</b></p>  <p>x1</p>	<p><b>G</b></p>  <p>x1</p>
<p><b>B</b></p>  <p>x1</p>	<p><b>E</b></p>  <p>x1</p>	
<p><b>C</b></p>  <p>x1</p>	<p><b>F</b></p>  <p>x1</p>	

# INSTRUÇÕES DE MONTAGEM

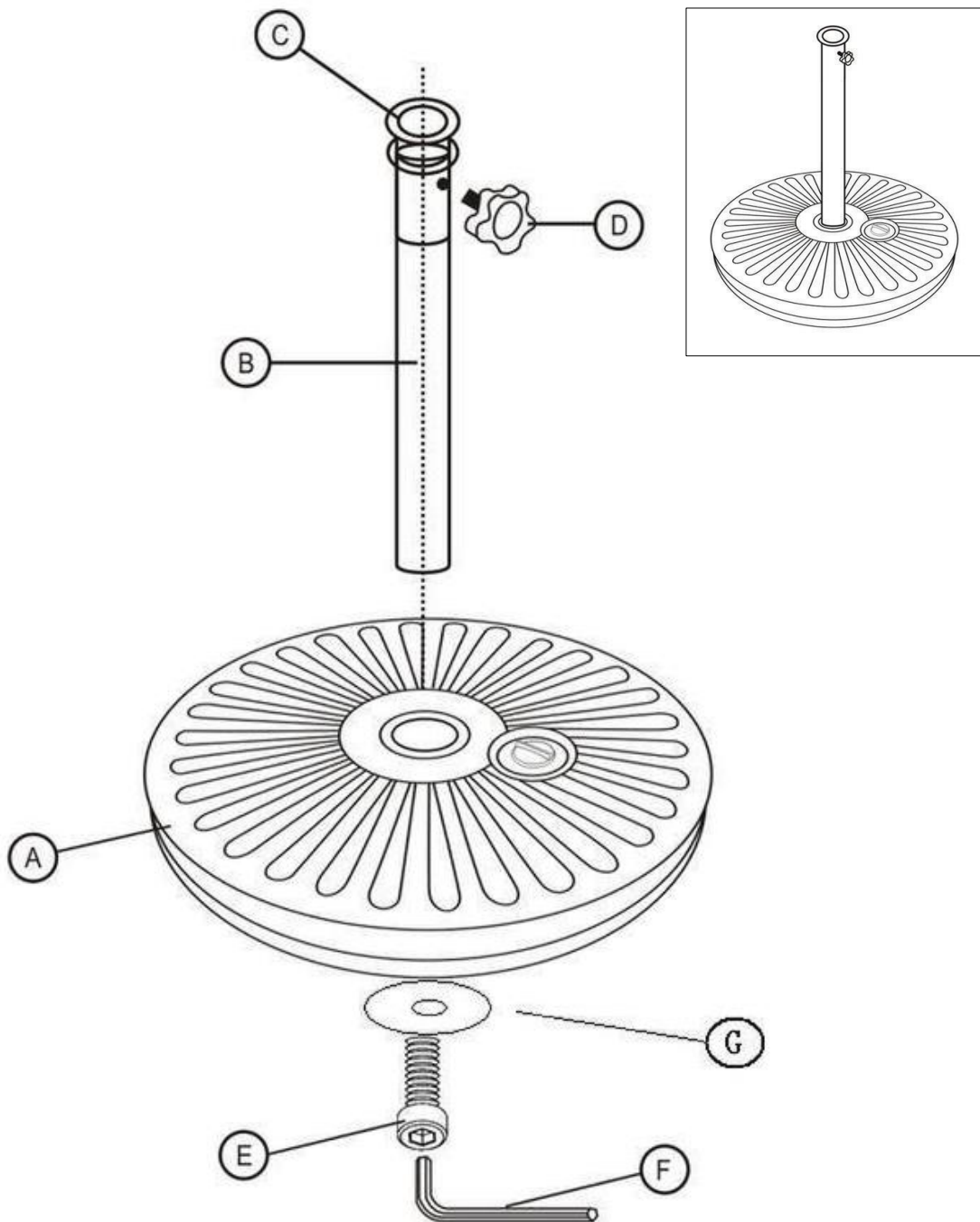

***rivatti***

[www.rivatti.com.br](http://www.rivatti.com.br)