

# MANUAL DE INSTRUÇÕES

## RECOMENDAÇÕES

Uso interno. Não expor ao sol ou umidade.

Não exceder a capacidade de peso.

## MANUTENÇÃO E LIMPEZA

Limpar com pano macio umedecido em solução de água e sabão neutro e secar em seguida.

Não utilizar produtos químicos ou abrasivos.

# MANUAL DE INSTRUÇÕES

## CADEIRA

# Marcela

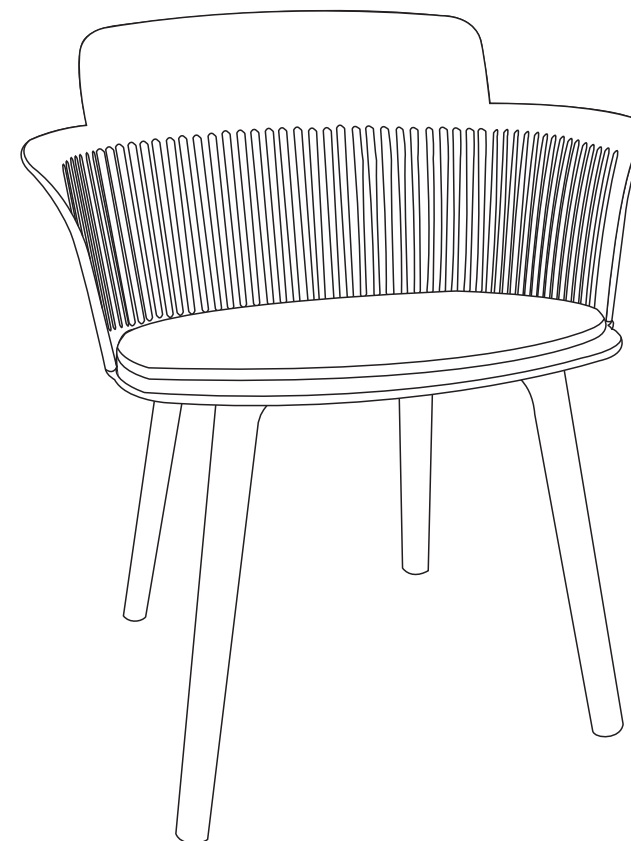

# COMPONENTES

1 UNID.

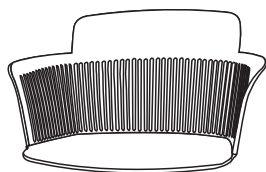

(A)

1 UNID.

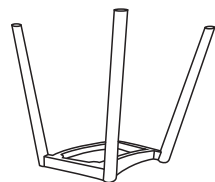

(B)

4 UNID.

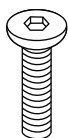

(C)

4 UNID.



(D)

1 UNID.

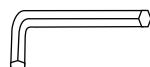

(E)

# INSTRUÇÕES DE MONTAGEM

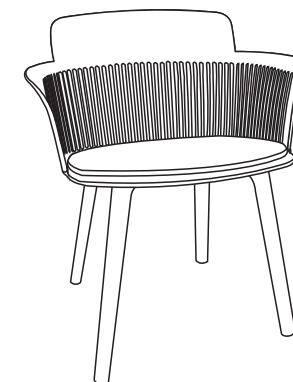
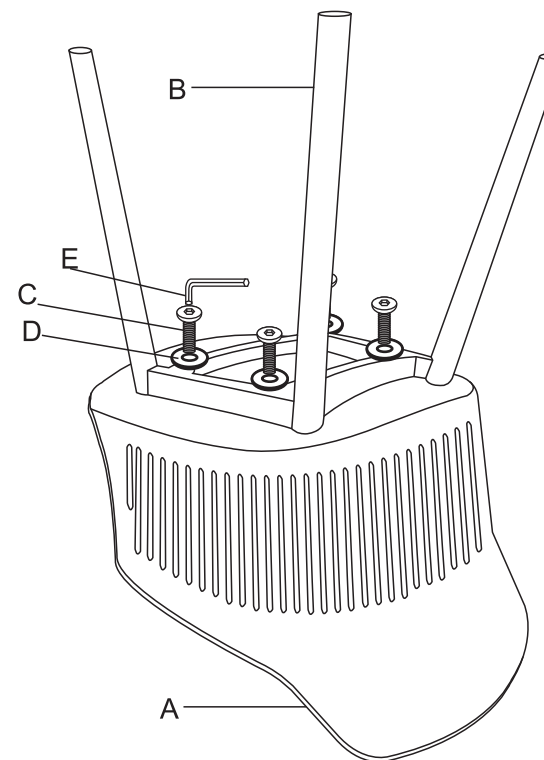

1