

**ARTEMOBILI**  
móveis com encaixe perfeito

## Mesa Fit

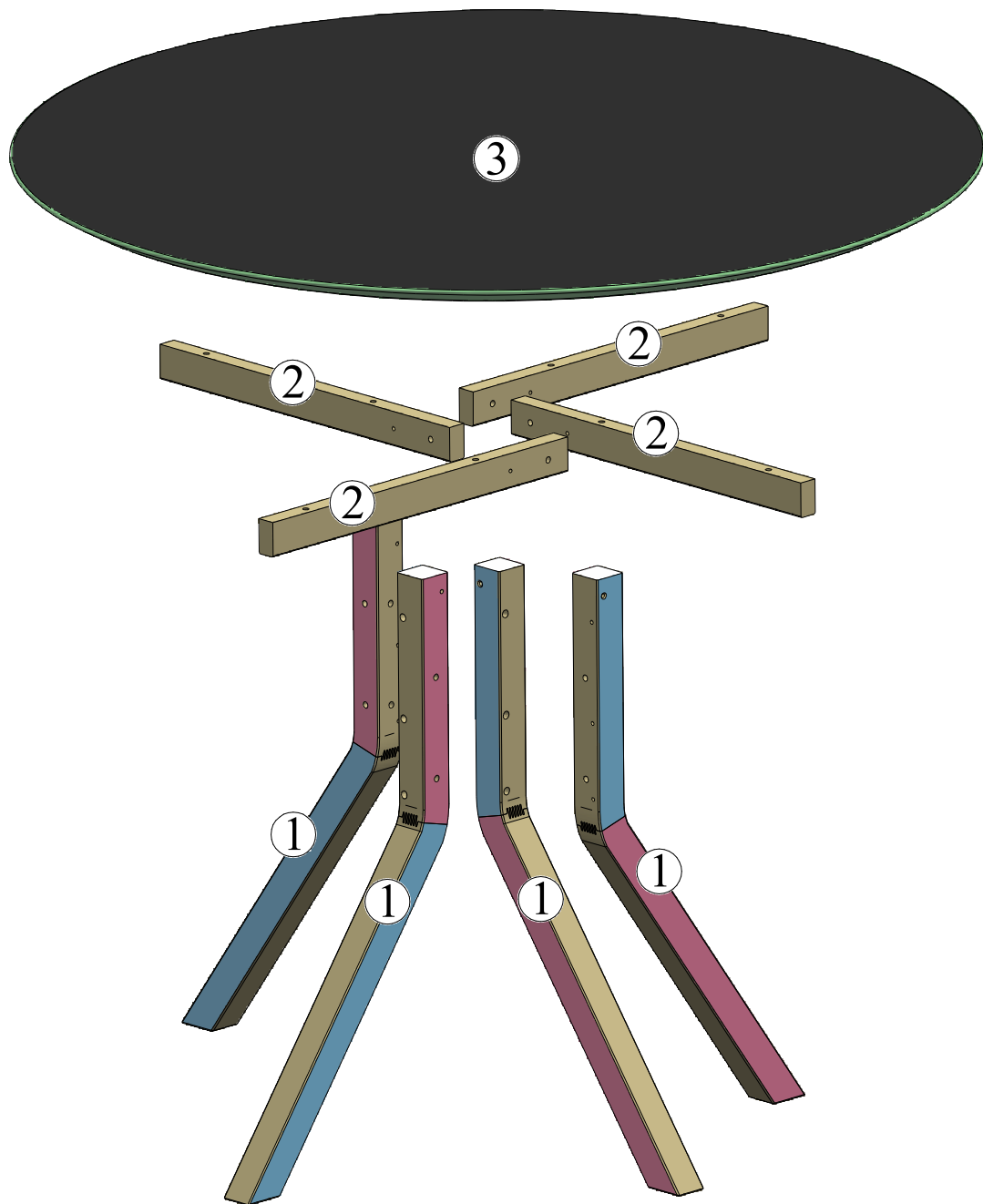

# Identificação das Peças



## Partes do Produto

1	Pé	(4x) - 726 x 345 x 44
2	Travessa do tampo	(4x) - 500 x 44 x 24
3	Tampo	(1x) - 1180 x 1180 x 24

# Identificação das Ferragens

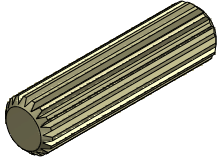

A- Cavilha 8x30 (8x)

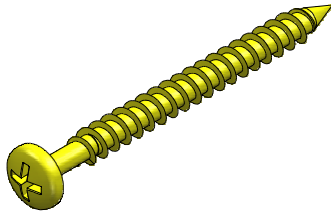

B- Parafuso 4,5x50 (16x)

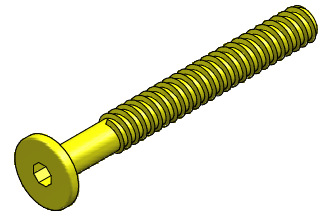

C- Parafuso 7x60 C13 (12x)

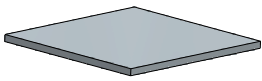

D- Feltro 25x25 (4x)

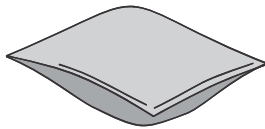

E- SACHE de cola (1x)



F- Tapa furo 17mm (12x)

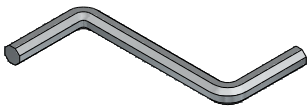

G- Chave zeta (1x)

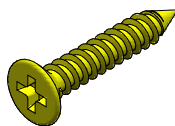

H- Parafuso 3,5x20 (32x)

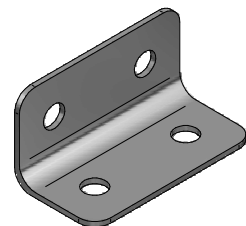

I- Cantoneira metálica (8x)

# PASSO 1)

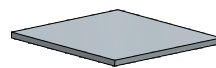
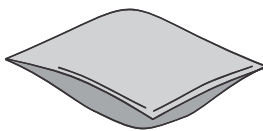
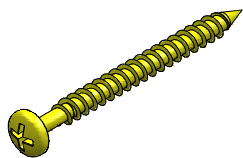
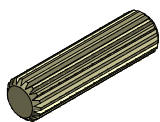

A- Cavilha 8x30 (4x)

B- Parafuso 4,5x50 (6x)

E- Sacle de cola (1x)

D- Feltro 25x25 (4x)

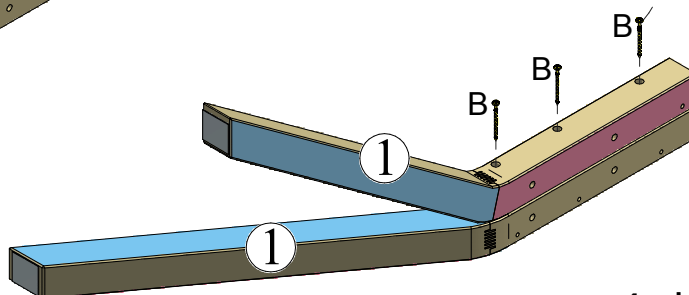
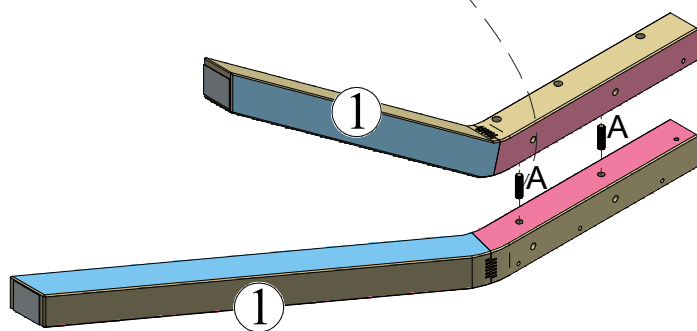
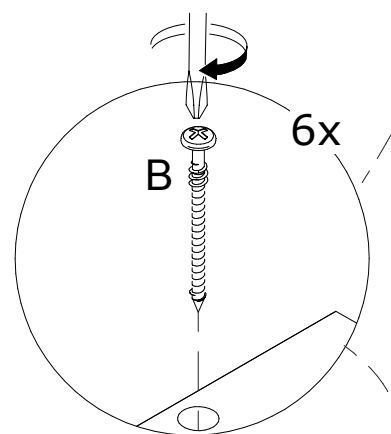
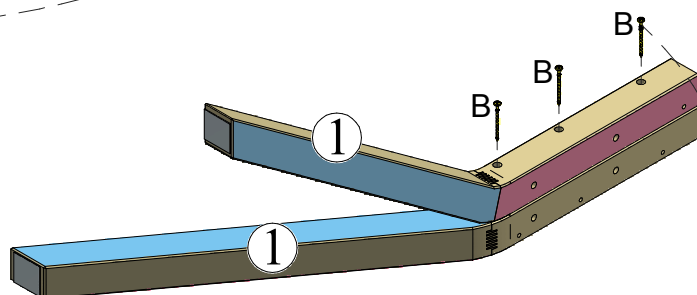
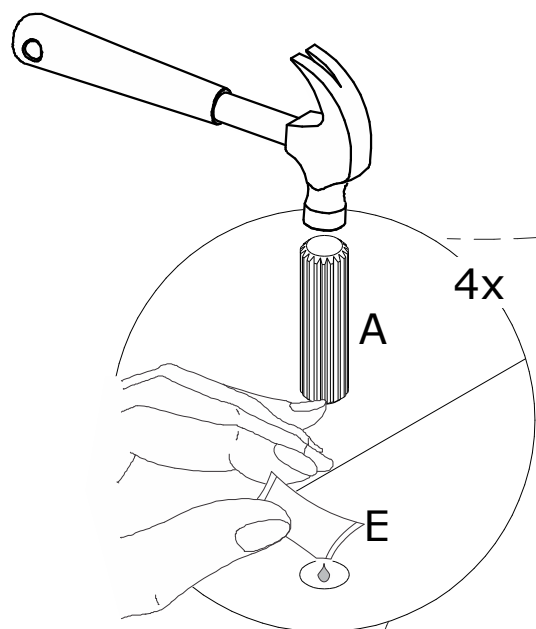
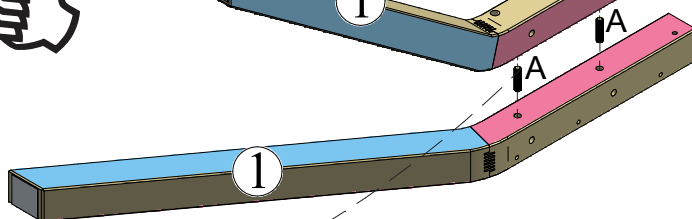
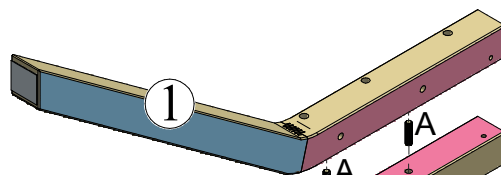
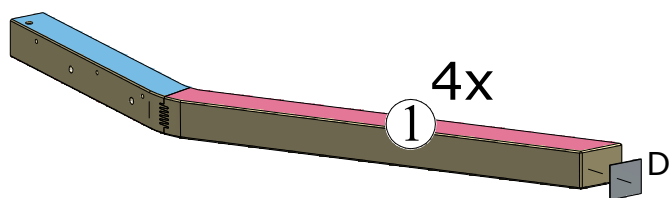

## PASSO 2)

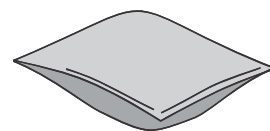
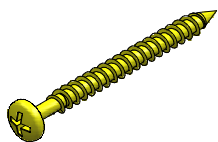
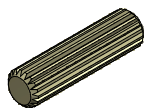

A- Cavilha 8x30 (4x) B- Parafuso 4,5x50 (6x) F- Tapa furo 17mm (12x) E- SACHE de cola (1x)

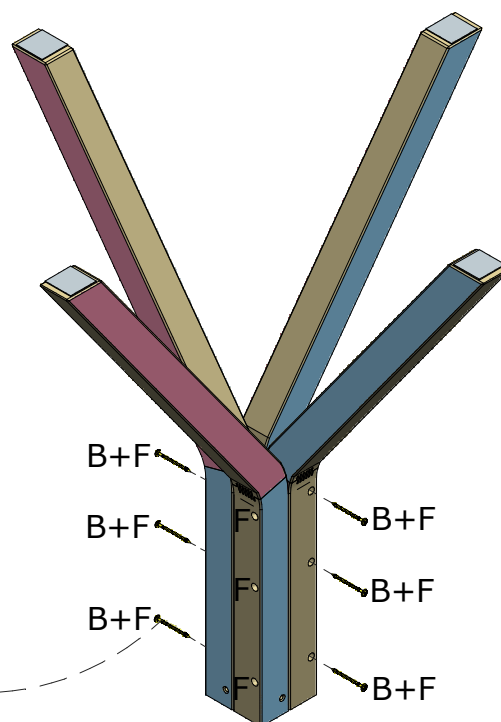
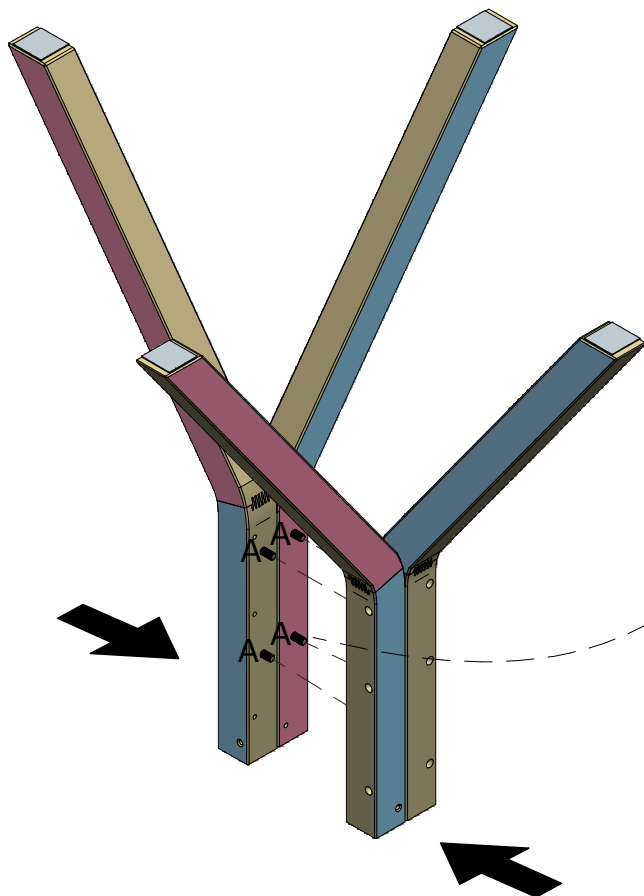

### PASSO 3)

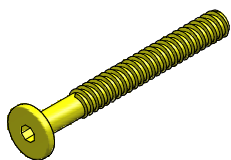

C- Parafuso 7x60 C13 (8x)

OBS: Pré fixar parafusos na furação das travessas até encontrar com a furação do tampo.

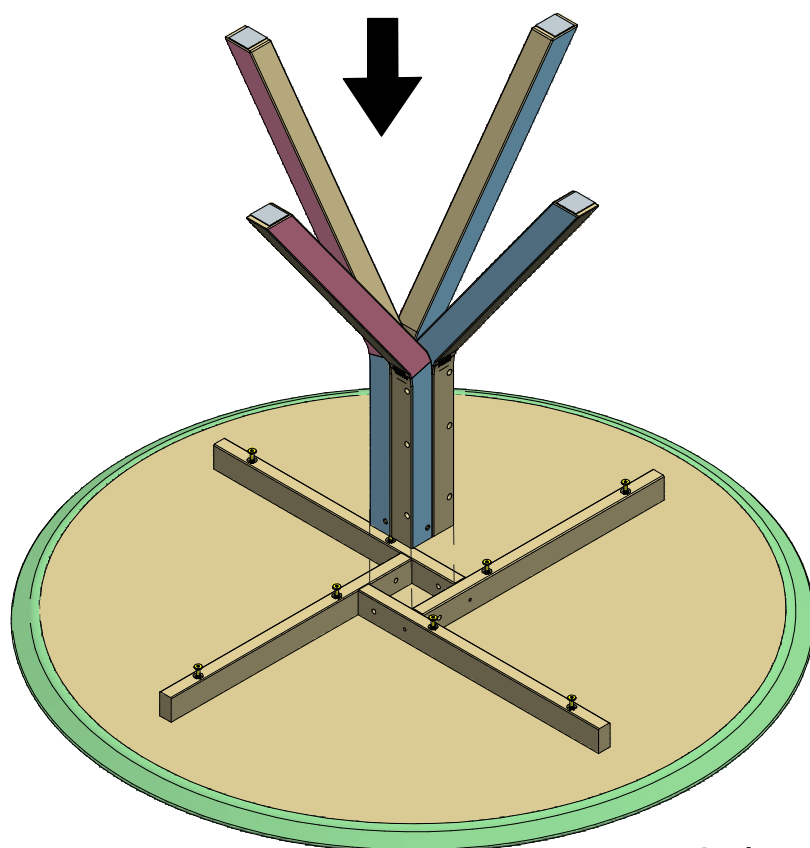
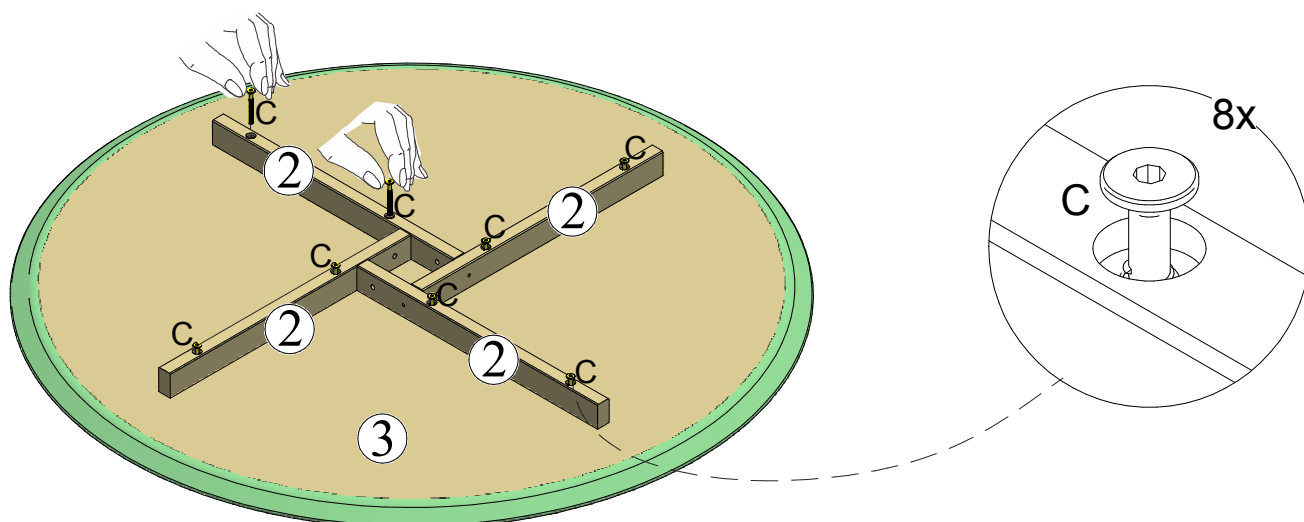

## PASSO 4)

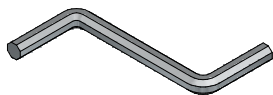
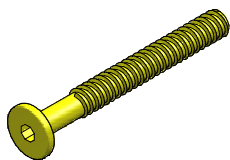

C- Parafuso 7x60 C13 (12x)

G- Chave zeta (1x)

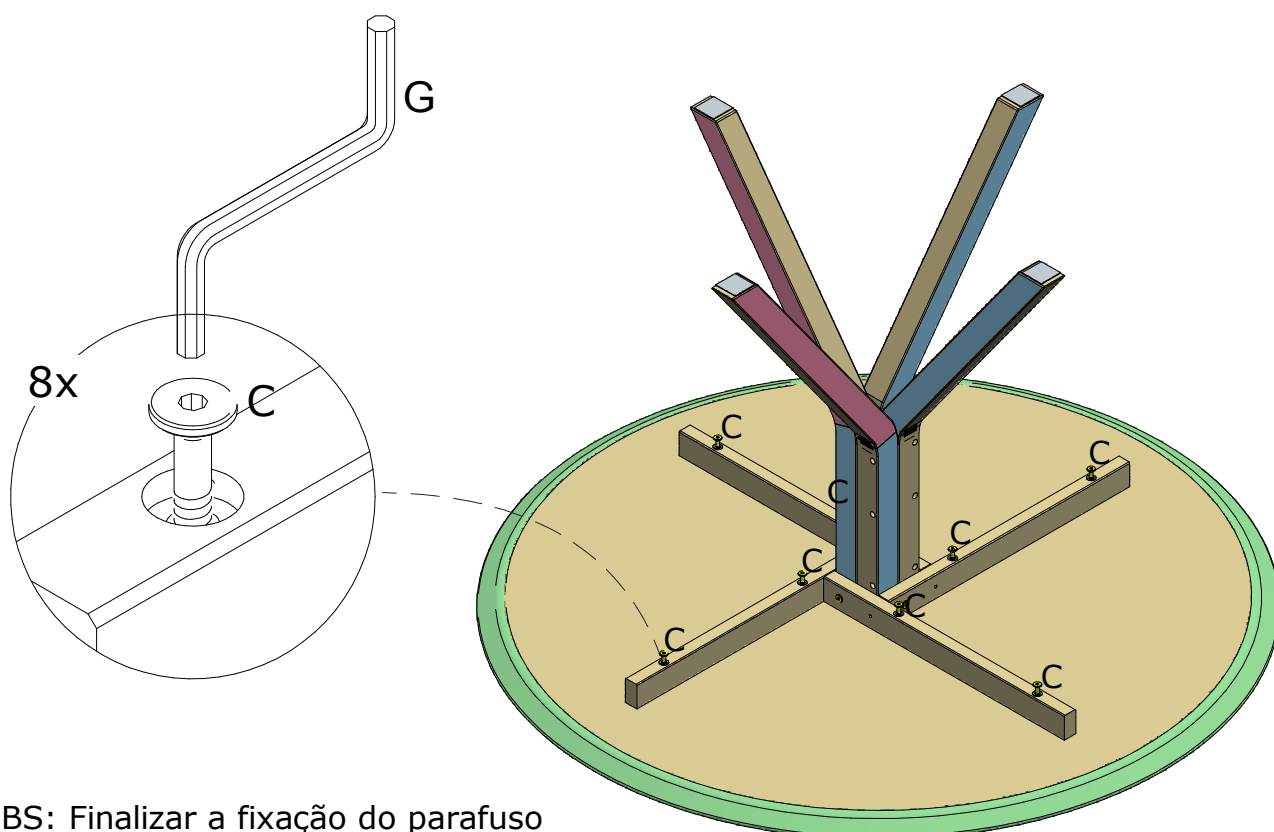
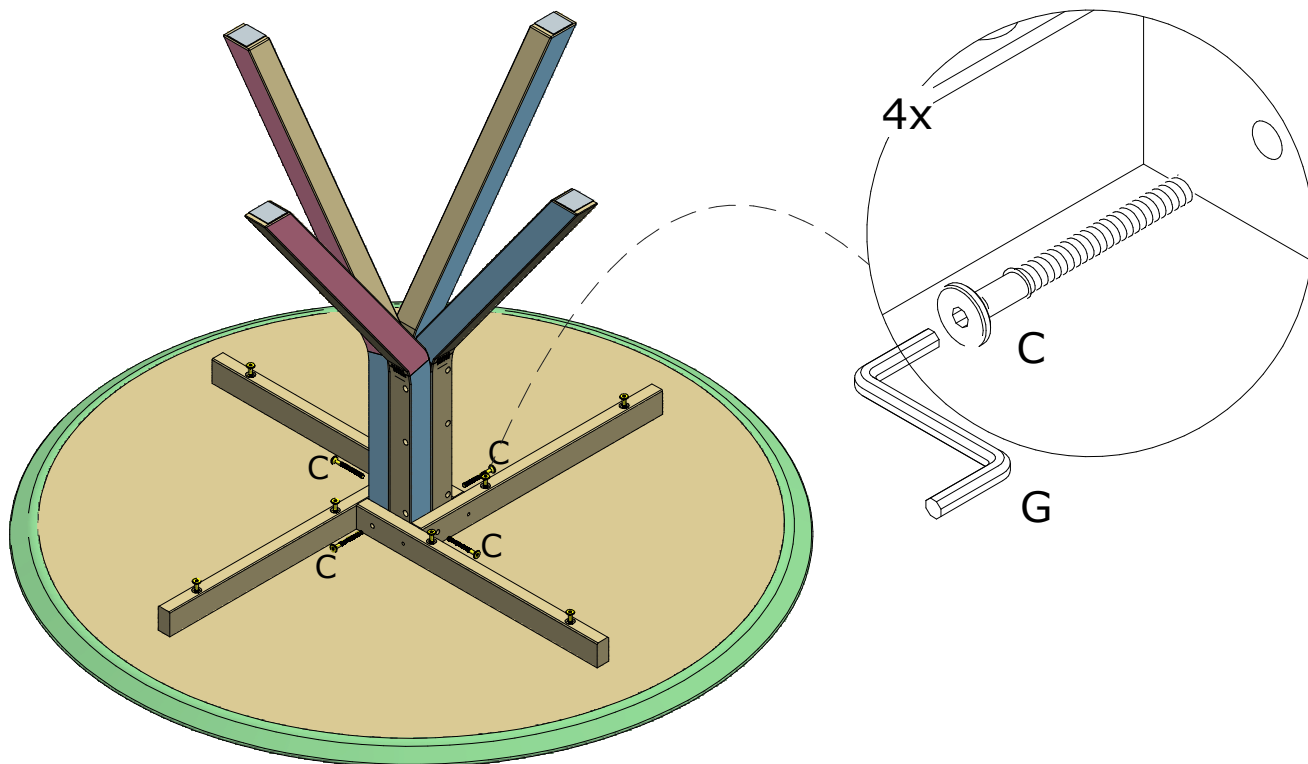

OBS: Finalizar a fixação do parafuso estrutural.

## PASSO 5)

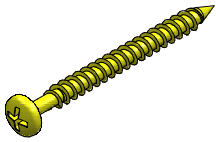

B- Parafuso 4,5x50 (4x)

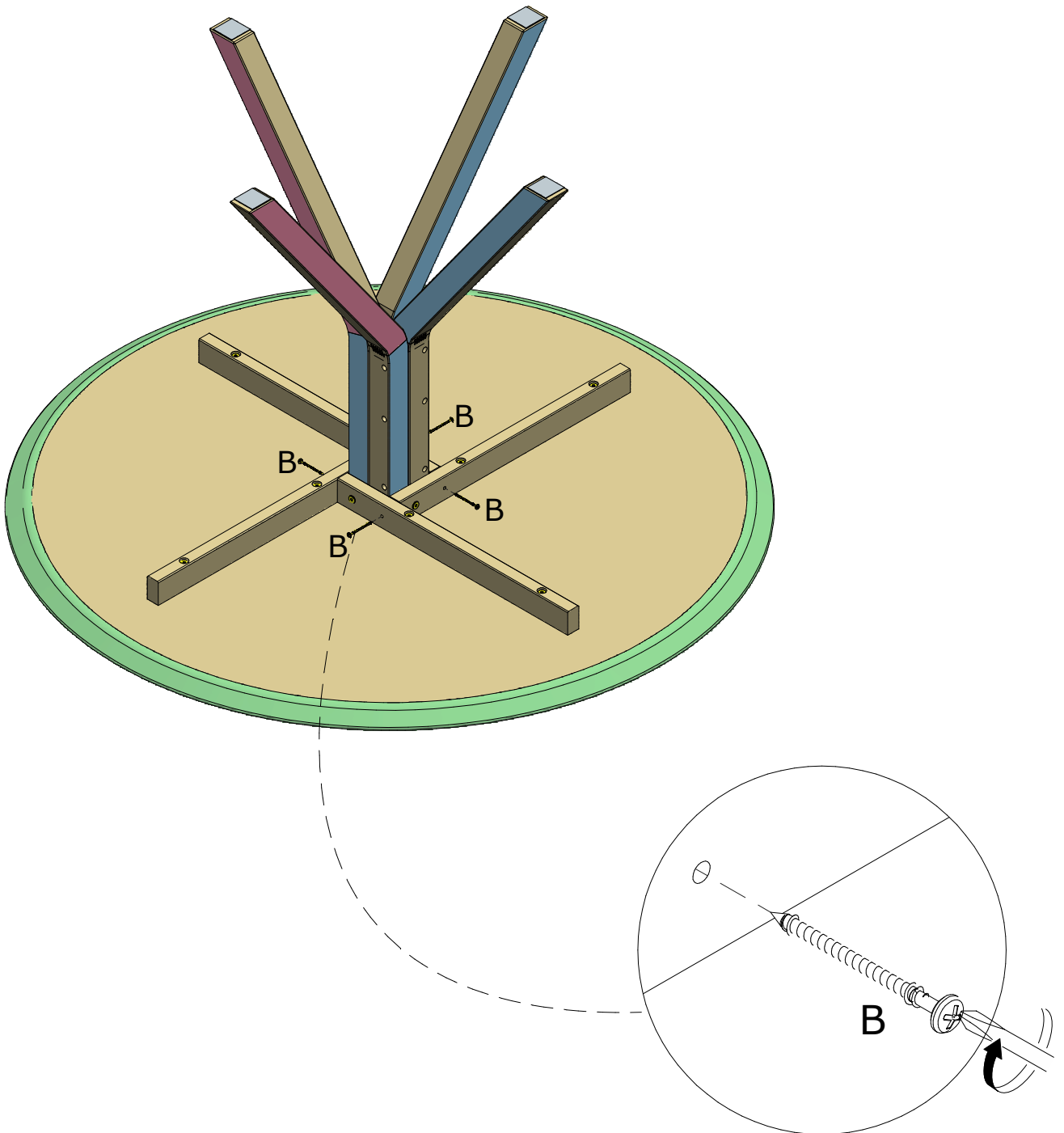

# PASSO 6)

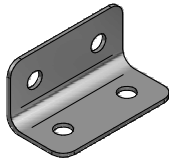

H- Parafuso 3,5x20 (32x)

I- Cantoneira metálica (8x)

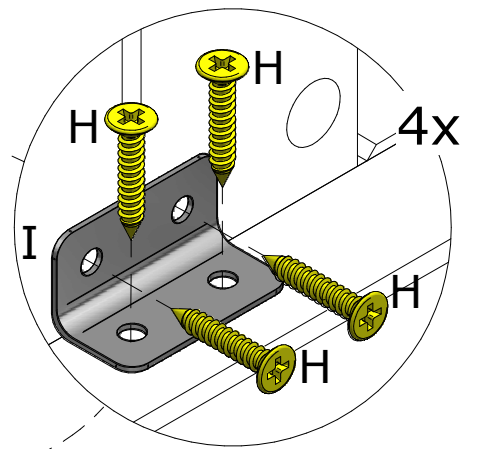
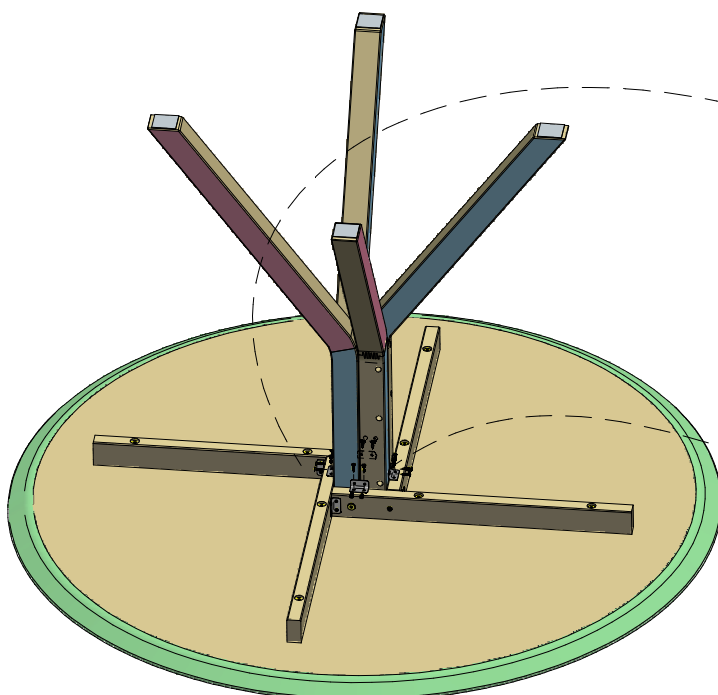
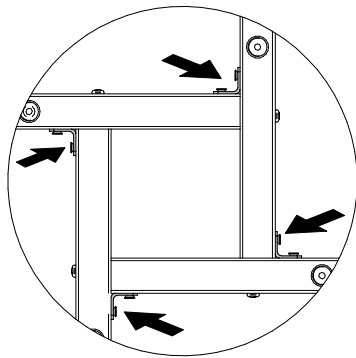
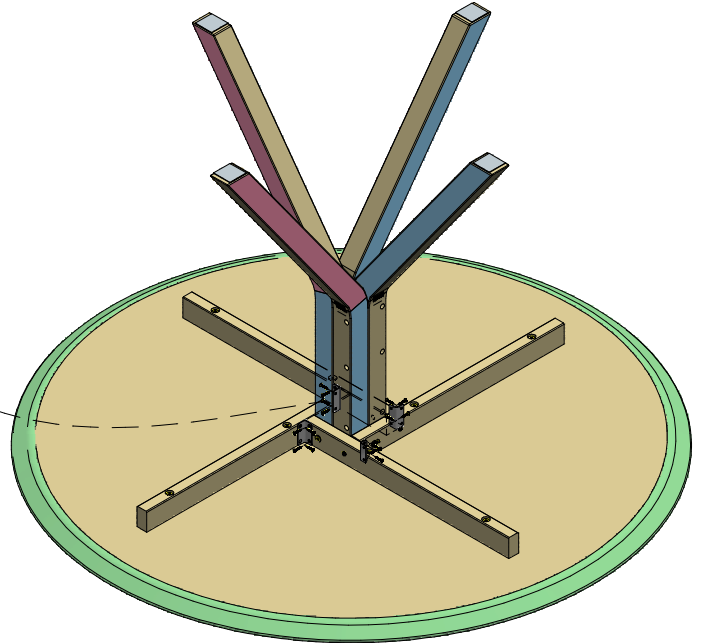
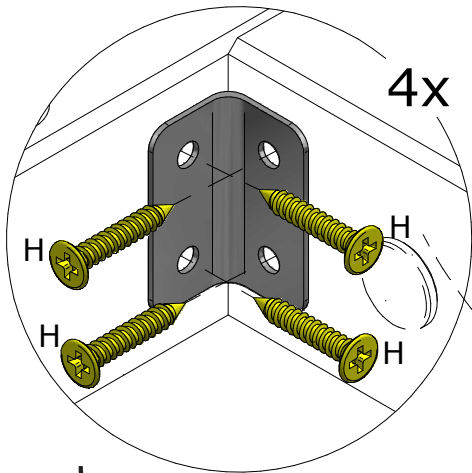

# CUIDADOS COM O MÓVEL

Para limpeza e conservação deste produto, use apenas um pano macio, umedecido com água e sabão neutro (sem amônia).

Não use álcool, detergentes, abrasivos, etc...

Não deixe este produto em contato com o sol, fonte de calor ou ambiente com muito pó.

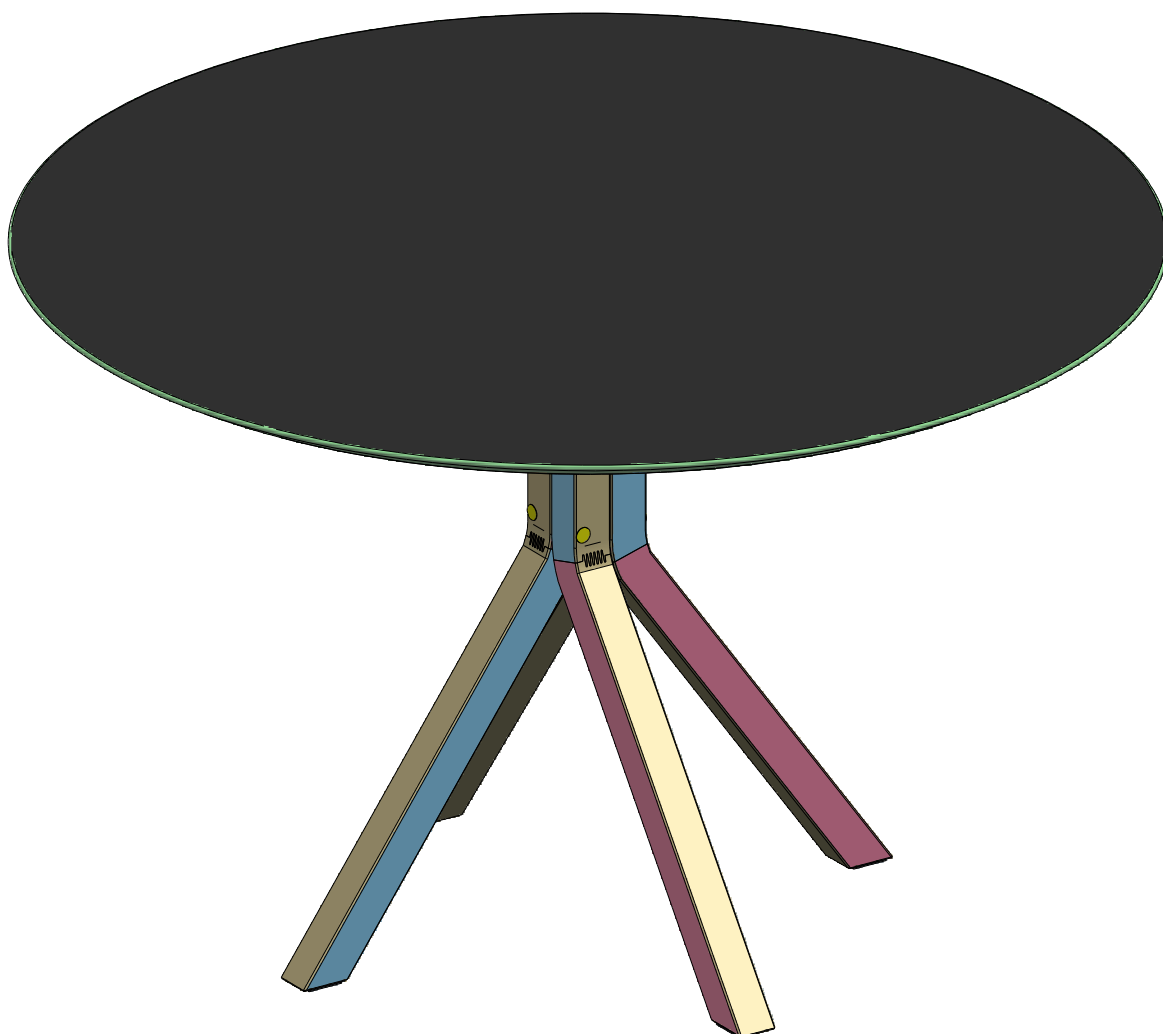

## Certificado de garantia

### Mesa

Com o intuito de garantir a sua satisfação e confirmar o nosso compromisso com a qualidade, queremos que leia atentamente nossas recomendações para o cuidado do seu móvel.

1. Proteja-o da incidência direta da luz solar.
2. Evite coloca-lo próximo de estufas ou saídas de ar condicionado.
3. Não deixe em lugar úmido e ambientes com muito pó.
4. Evite objetos pontiagudos sobre a superfície.
5. Para limpeza deste produto, use apenas um pano macio, umidecido com água e sabão neutro.
6. Não use álcool, detergentes, abrasivos, etc...
7. A montagem deverá obedecer as instruções do manual, a montagem efetuada de maneira incorreta acarreta na perda de garantia.
8. Em caso de mudança de endereço possíveis avarias no transporte perderão a garantia.
9. Aperte os parafusos periodicamente.

**IMPORTANTE:** todas não conformidades deverão ser apontadas no momento do recebimento do produto.

### **Prazo de garantia:**

Será de seis (06) meses a garantia do móvel por defeitos de fabricação, ressalvadas condições normais de uso e as demais condições do presente certificado, contados da data da emissão da nota fiscal.

**\*\* O certificado de garantia só será válido se apresentado juntamente com a nota fiscal.**