

# MANUAL DE MONTAGEM

## INSTRUCCIONES DE MONTAJE

### ASSEMBLY INSTRUCTIONS

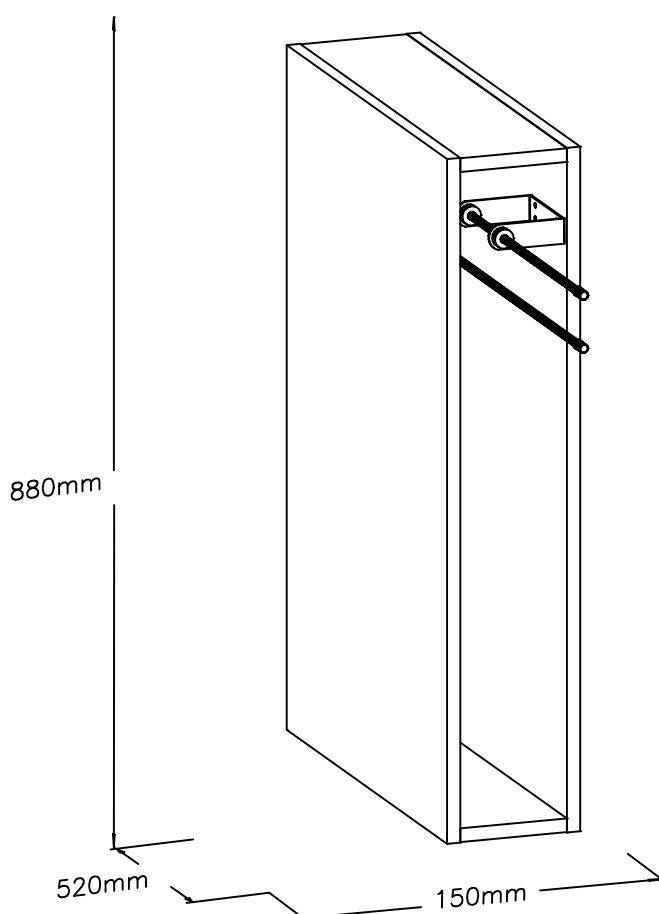

## ATENÇÃO / PRECAUCIÓN / ATTENTION:

- 1 – Ler atentamente todo o manual antes de iniciar a montagem do móvel.
- 2 – A montagem deve ser feita em uma superfície plana e limpa.
- 3 – Recomenda-se utilizar a embalagem do móvel para forrar e chão e assim não danificá-lo.
  - 1 – Lea cuidadosamente todo el manual antes de comenzar el montaje.
  - 2 – La instalación debe hacerse sobre una superficie plana y limpia.
  - 3 – Recomanda ser utilizado para empaquetar móvil a la línea y tierra y por lo tanto dañar ellos.
- 1 – Read the entire manual carefully before starting the furniture assembly.
- 2 – The assembly must be done on a flat and clean surface.
- 3 – It is recommended to use the packaging of the furniture to cover and floor and thus not to damage them.

## LIMPEZA E CONSERVAÇÃO / LIMPIEZA Y CONSERVACIÓN / CLEANLINESS AND CONSERVATION:

A limpeza do móvel deve ser feita com utilização de pano umedecido com água, podendo conter uma pequena quantidade de álcool. Não utilize produtos abrasivos.

La unidad de limpieza se debe realizar con el uso de paño humedecido con agua y puede contener una pequeña cantidad de alcohol. No utilice productos abrasivos.

The furniture should be cleaned with a cloth dampened with water and may contain a small amount of alcohol. Do not use abrasive products.

## GARANTIA / GARANTÍA / WARRANTY:

90 dias para defeitos de fabricação.

90 días a defectos de fabricación.

90 days for manufacturing defects.

## FERRAMENTAS NECESSÁRIAS / HERRAMIENTAS NECESARIAS / TOOLS REQUIRED:

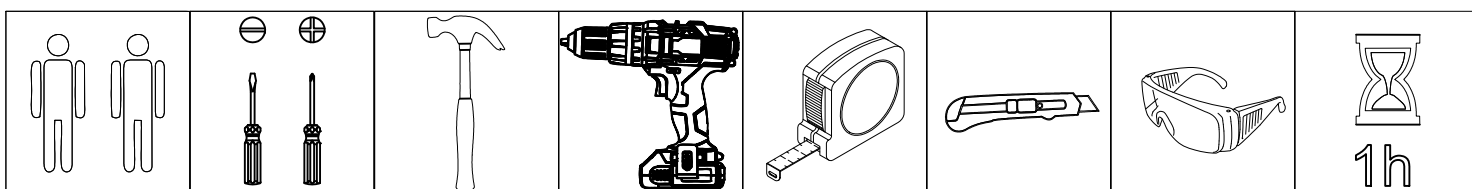

Acesse as dicas de  
montagem no Youtube

Accede a los consejos de  
montaje en Youtube.

Access the mounting tips on  
Youtube.







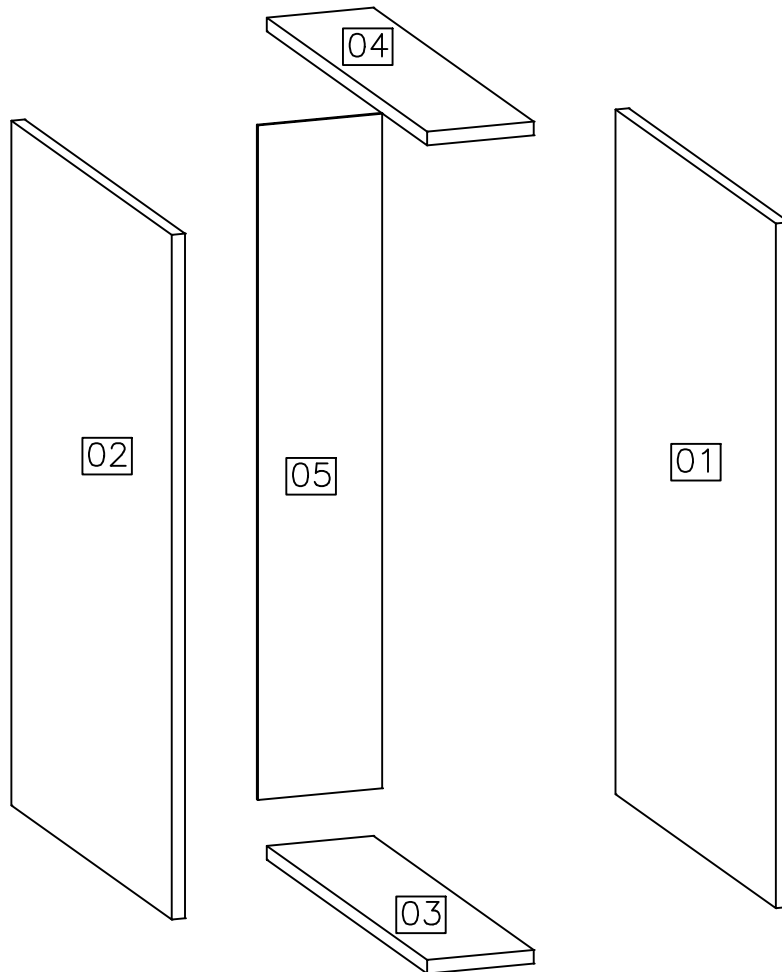

[www.youtube.com/MoveisKappesberg](http://www.youtube.com/MoveisKappesberg)

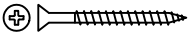
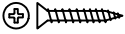

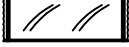
## Lista de peças / Lista de piezas / List of pieces

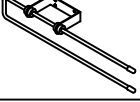
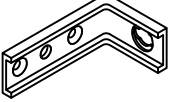
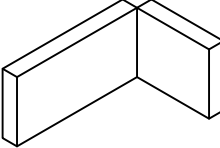
Código/ Código/ Code	Descrição	Descripción	Description	Quantidade/ Cantidad/ Amount	Comprimento/ Longitud/ Length (mm)	Largura/ Ancho/ Width (mm)	Espessura/ Espesor/ Thickness (mm)	Caixa/ Caja/ Box
01	Lateral direita	Lateral derecha	Right side	1	750	496	15	A
02	Lateral esquerda	Lateral izquierda	Left side	1	750	496	15	A
03	Base	Pieza de suelo	Base	1	496	120	15	A
04	Tampo	Tapa del cajón	Top of drawers	1	496	120	15	A
05	Costa	Pieza del fondo	Back panel	1	740	140	3	A

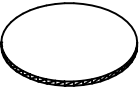

Ferragem / Herrajes / Hardware			
	Código/ Código/ Code	Descrição / Descripción / Description	Quan. / Cant./ Amou.
A	50311	 Parafuso/ Tornillo/ Screw 5,0x65	2
B	226	 Parafuso/ Tornillo/ Screw 4x40	8
C	491	 Parafuso/ Tornillo/ Screw 4x25	4
D	4214	 Parafuso/ Tornillo/ Screw 3,5x14	6
E	1802	 Cavilha/Tarugo/ Peg 6x30mm	8
F	41	 Cola branca em bislaga/Cola blanca/White glue (10g)	1
G	107	 Prego/Clavo/Nail 10x10	18
H	957	 Porta toalha/Puerta de la toalla/ Towel door	1
I	17024	 Suporte aéreo zb/Soporte de seguridad/Safety bracket	1
J	6959	 Capa para suporte branca/Cubierta de soporte/Support cover	1
K	529	 Bucha invasa/Adapter sleeve/ Manga del adaptador	1
L	FR=51255 (Freijo)	 Tapa furo/Tapa del agujero/Tap hole 13mm	8
M	58	 Etiqueta marca/Tag label "Kappesberg"	1
01 Saco pequeno para acessórios			



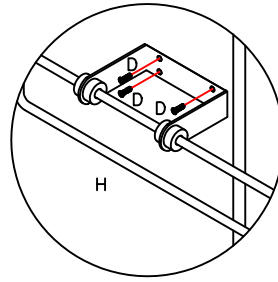
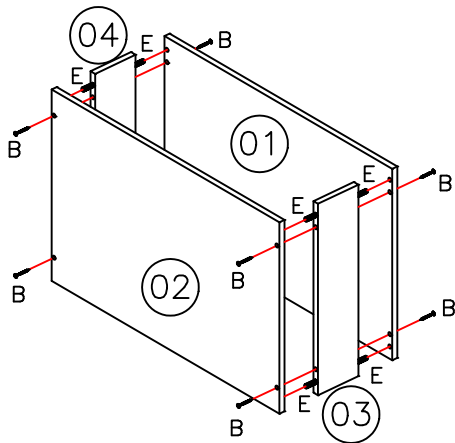

Caso deseje colocar o porta toalha "H", fixe-o com o parafuso "D".

Si desea colocar el porta toallas "H", fíjelo con el tornillo "D".

If you wish to fit the towel carrier "H", secure it with the screw "D".

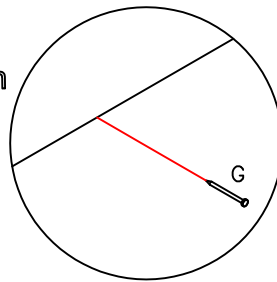
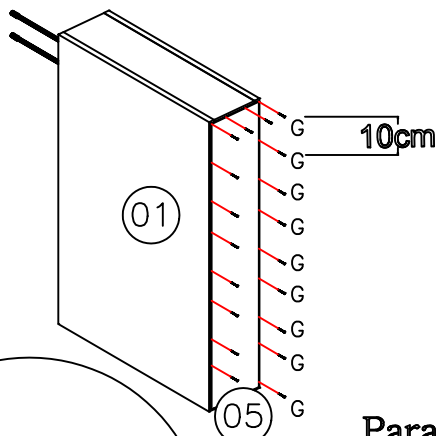

Para montar a cozinha suspensa:

- Utilize o rodapé frontal que acompanha o móvel como apoio para sua fixação na parede, utilizando a bucha "K" e o parafuso "A".
- Em uma lateral fixe um suporte aéreo metálico "I" com o parafuso "D" e na parede com o parafuso "A" e com a bucha "K".
- Coloque uma capa "J" em cada suporte "I".

Para montar la cocina suspendida:

- Use el zócalo frontal que viene con los muebles como soporte para su montaje en la pared utilizando el casquillo "K" y el tornillo "A".
- Por un lado, fije un soporte neumático metálico "I" con el tornillo "D" y la pared con el tornillo "A" y el casquillo "K".
- Coloque una cubierta "J" en cada soporte "I".

To mount the kitchen suspended:

- Use the front skirting board that comes with the furniture as a support for its wall mounting using the "K" bush and the "A" screw.
- On one side, fix a metallic air support "I" with the screw "D" and the wall with the screw "A" and the bushing "K".
- Place a "J" cover on each "I" bracket.

