

BANQUETA VERSÁTIL

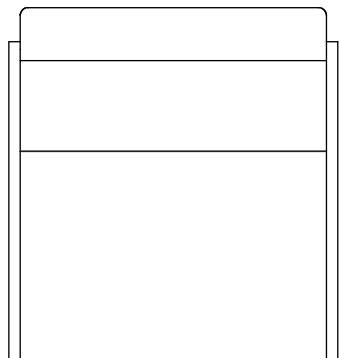

A: 440mm
L: 435mm
P: 385mm

RELAÇÃO DE PEÇAS

Nº PEÇA	DESCRIÇÃO	QTD.	MEDIDAS
01	LATERAL	02	420X385X15
02	TRAVAS	02	405X120X15
03	ASSENTO	01	410X375X70

ATENÇÃO

Conferir as medidas dos parafusos e acessórios na escala abaixo antes de utilizá-los.

MEDIDAS EM mm

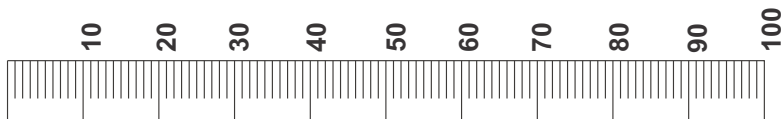

A 08X

B 08X

C 08X

D 16X

E 04X



PARAF. GIROFIX



TAMBOR
GIROFIX



CANTONEIRA



PARAF. CHATO
3,5X12mm

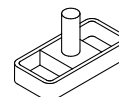

SAPATA

FERRAMENTAS NECESSÁRIAS

(FERRAMENTAS NÃO FORNECIDAS PELA EMPRESA)

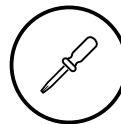

CHAVE PHILIPS

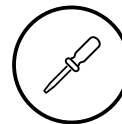

CHAVE FENDA

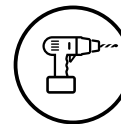

FURADEIRA

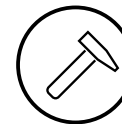

MARTELO

RECOMENDAÇÕES DE USO

- 1- O produto deve ser transportado em sua embalagem para que sejam preservadas suas características;
- 2- A limpeza e manutenção do produto deve ser feita com pano úmido, sem adição de produtos químicos;
- 3- A montagem deve atender aos passos especificados no roteiro de montagem, que se encontra em anexo ao produto;
- 4- Evitar locais úmidos ou com excessiva luz do sol, para maior durabilidade do produto.

1

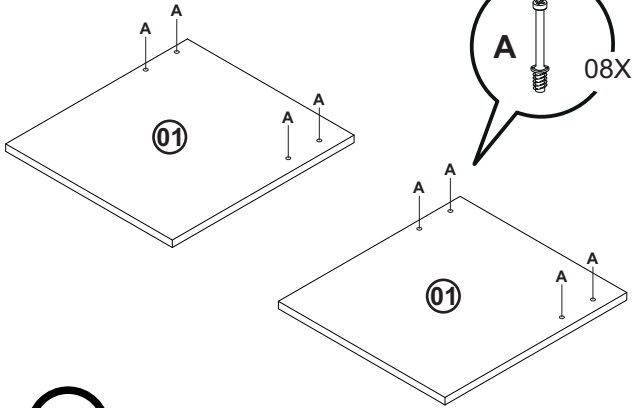

2

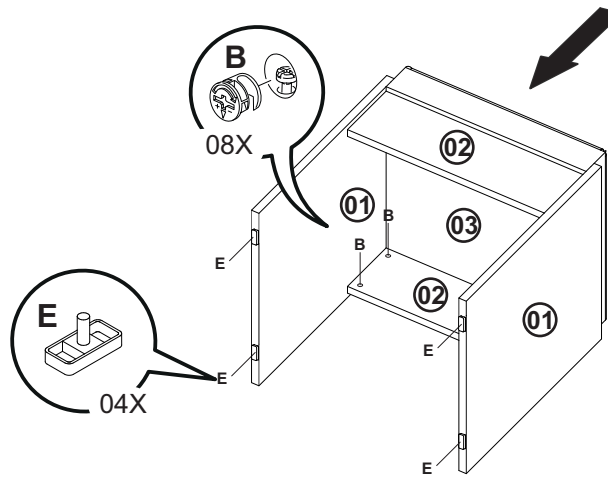

3

