

MESA DE CABECEIRA EASY C/ GAVETA

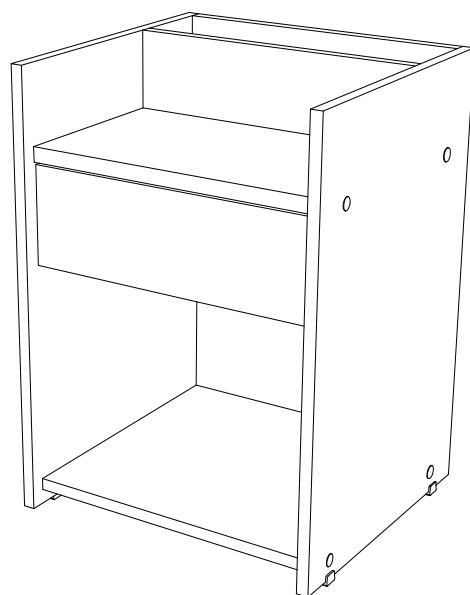

**ESCANEI-ME
PARA ACESSO AO
VÍDEO DE MONTAGEM**



Utilizar a régua abaixo para medir os componentes.



Composição do Produto

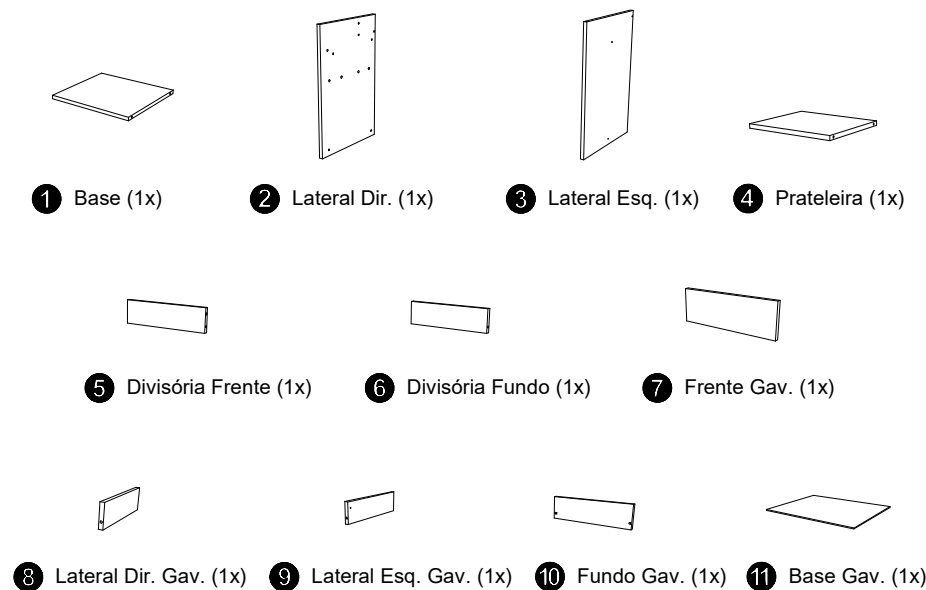

Componentes de Montagem



A- Parafuso phillips chipboard 3x30 (8x)



B- Cavilha 6x30 (18x)



C- Tapa furo adesivo branco (8x)



D- Sapata "L" (4x)

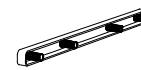

E- Corrediça Plástica (2x)



F- Suporte Prateleira (2x)



G- Cantoneira 2 furos (2x)



H- Parafuso phillips chipboard 4x12 (8x)



I- Pregos 10x10 (9x)

Atenção

- 1- Leia atentamente toda a instrução antes de iniciar a montagem.
- 2- A montagem do produto deverá ser feita em uma superfície limpa e plana. Aconselhamos utilizar a própria embalagem para forrar o chão a fim de não danificar o produto.
- 3- Reservar área livre para montagem do produto.



Pessoas necessárias para montar o produto



Tempo de montagem aproximado



Grau de dificuldade



Não utilizar químicos ou abrasivos na limpeza, evitar batidas e contato com objetos cortantes



Pano umedecido com água seguido de pano seco



Capacidade máxima suportável, distribuída uniformemente

1 Montagem

Ferramenta necessária para montagem

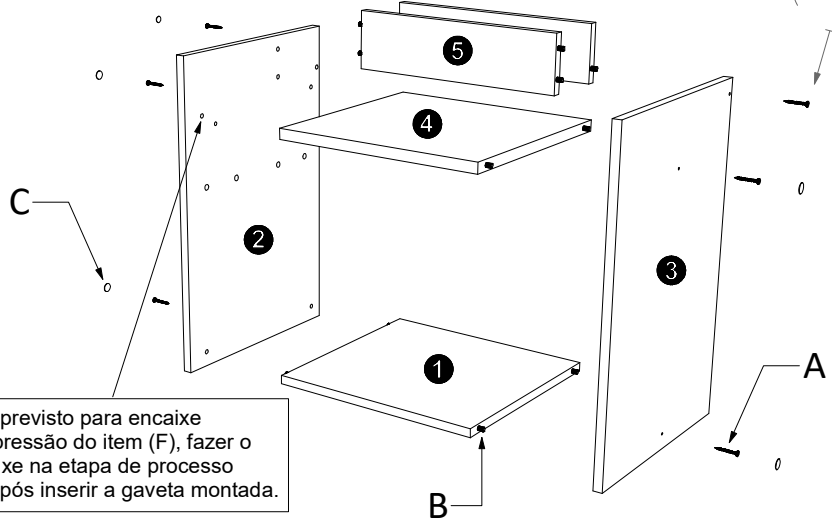
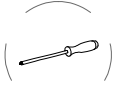

Furo previsto para encaixe sob-pressão do item (F), fazer o encaixe na etapa de processo (3), após inserir a gaveta montada.

2

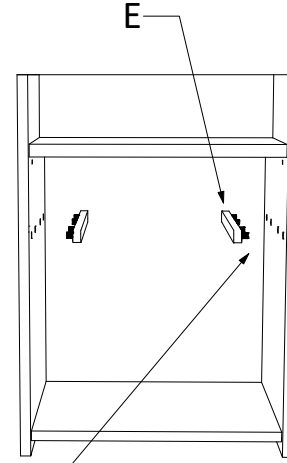

Encaixar item (E) nos furos sob-pressão

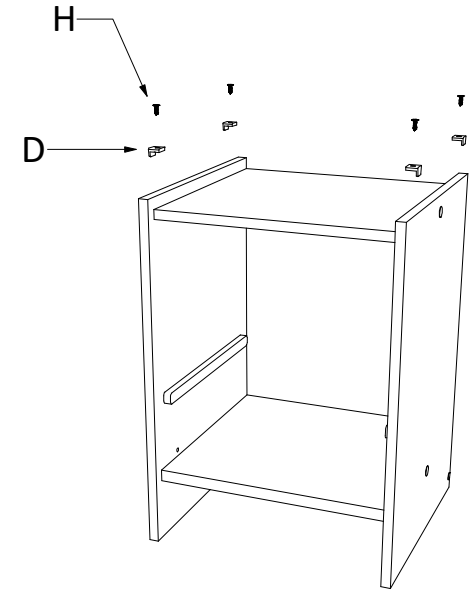

3

Ferramenta necessária para montagem



Encaixar item (F) após inserir a gaveta montada

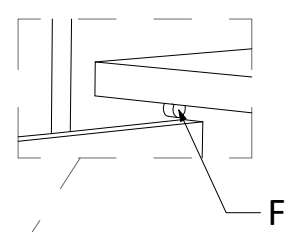

Ferramenta necessária para montagem

