

HECOL INDÚSTRIA E COMÉRCIO DE MÓVEIS LTDA
RUA ARLINDO BACCIN, 601 | BAIRRO VINHEDOS
CAIXA POSTAL 847 | CEP 95700 - 000 | FONE/FAX (54) 3454 - 5900
BENTO GONÇALVES | RIO GRANDE DO SUL | BRASIL
EMAIL: HECOLMOV@TERRA.COM.BR
WWW.HECOLMOVEIS.COM.BR

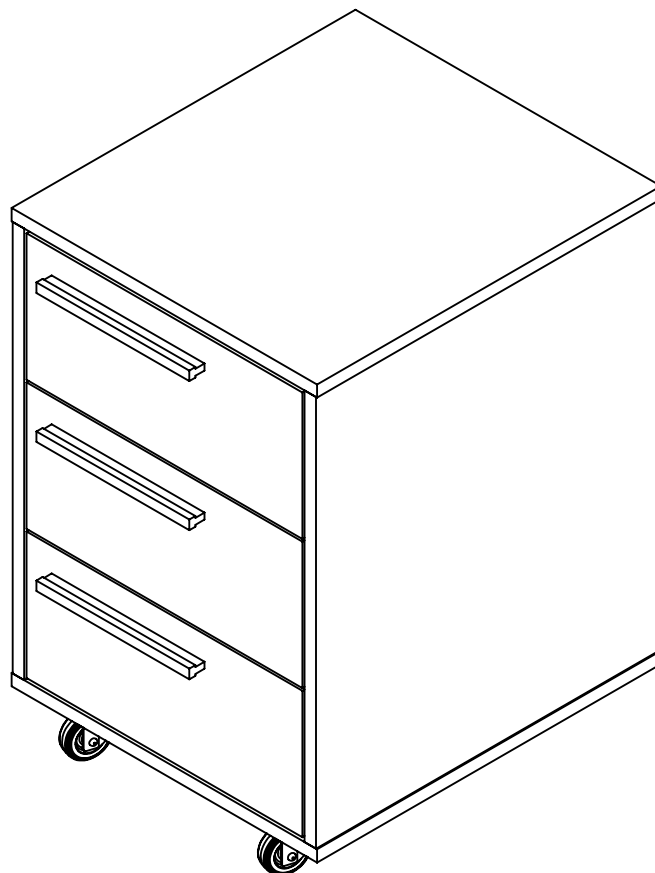

DICAS DE CONSERVAÇÃO

- Não utilizar na limpeza produtos abrasivos tais como: palha de aço, álcool, vinagre, limão, saponáceo, ou produtos corrosivos que possam riscar ou descolar a película protetora dos móveis;
- Na limpeza de móveis em geral, deve ser utilizado um pano levemente umedecido e sabão neutro;
- Para a movimentação do móvel, é importante que este seja levantado do chão, pois ao arrastá-lo pode causar avarias estruturais;
- Não deixe o móvel em exposição a intempéries;

Ferramentas

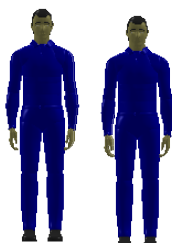
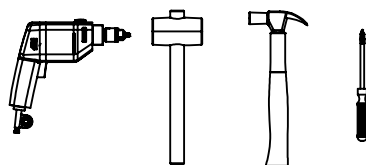

30 Min

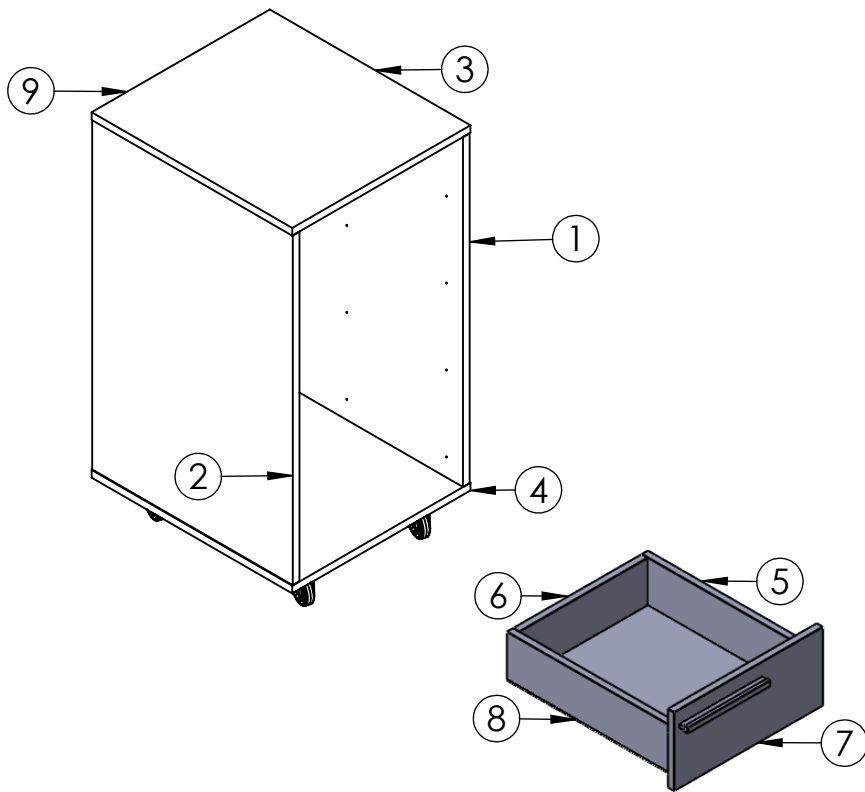

Nº	DESCRIÇÃO	QTD.
1	Lateral Direita	1
2	Lateral Esquerda	1
3	Tampo	1
4	Base	1
5	Lateral de Gaveta	6
6	Costa de Gaveta	3
7	Frente de Gaveta	3
8	Fundo de Gaveta	3
9	Costa	1

CC - Cabeça Chata Cp - Cabeça Panela Cf - Cabeça Flangeada

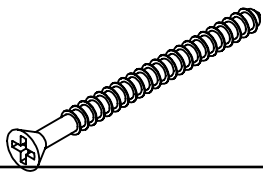

A Parafuso 4,5 x 45 CC 4

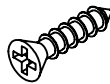

B Parafuso 3,5x12 CC 24



C Parafuso 3,5x12 CP 30

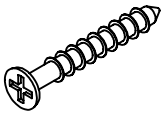

D Parafuso 3,5x25 CF 6

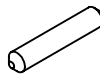

E Cavilha Madeira 8x30 20

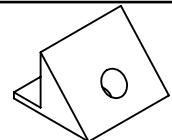

F Cantoneira Suporte Triangular 6

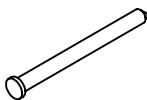

G Pregão 10x10 40

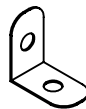

H Chapa "L" 12

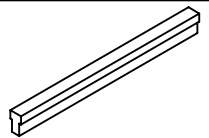

M Puxador 3

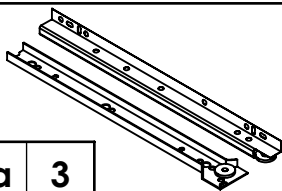

O Corrediça 3

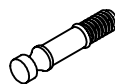

P Parafuso Minifix 4



Q Tambor Minifix 4

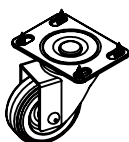

R Rodizio 4

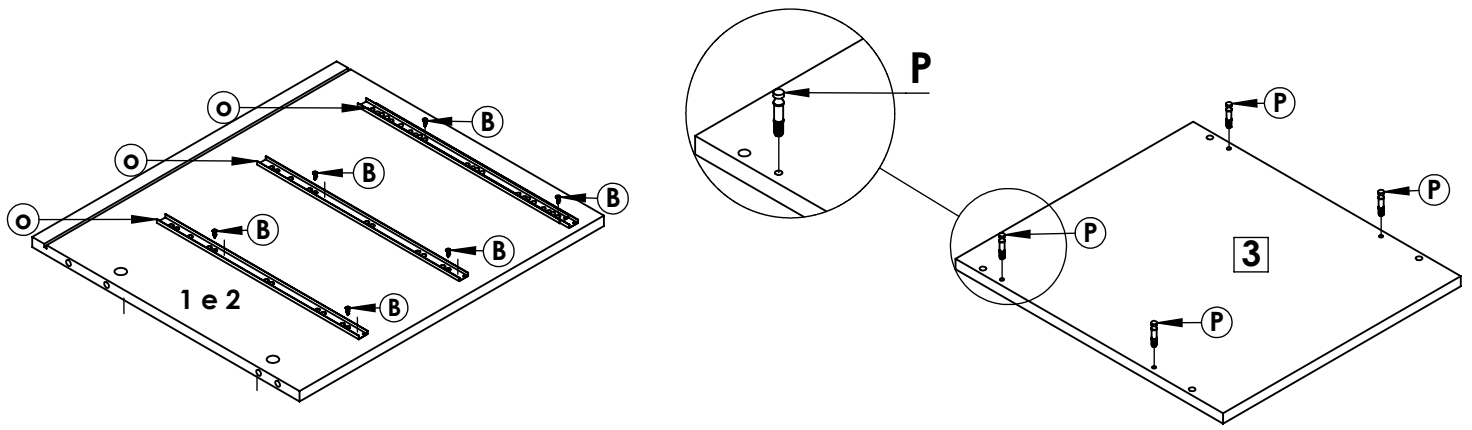

Fixar as Corrediças nas Peças (1) e (2)

