

2155 - CABECEIRA RECIFE

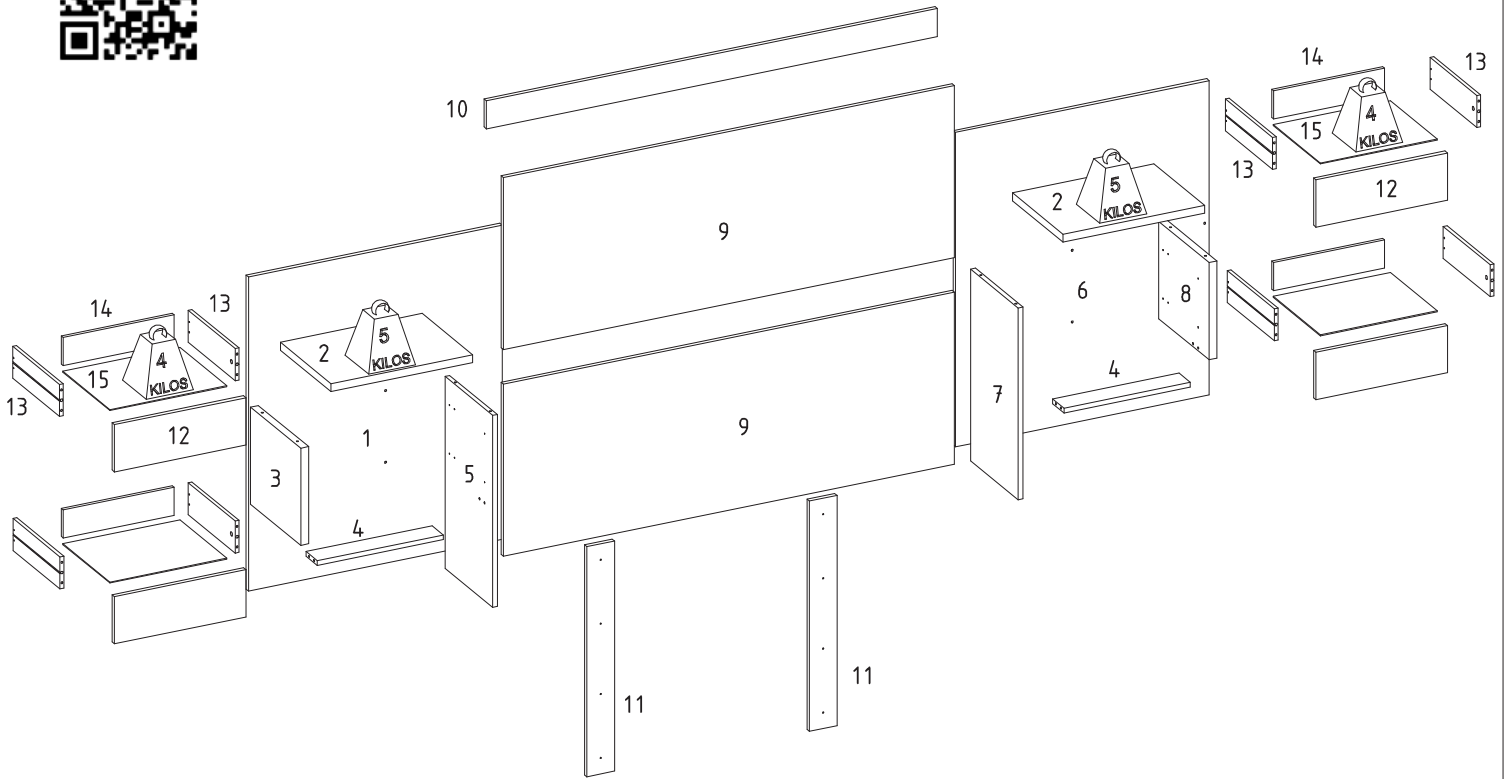

LISTA DE PEÇAS / Pieces List / Lista de Piezas

SEQ.	REF.	DESCRIÇÃO	DESCRIPTION	DESCRIPCIÓN	MAT.PRIMA	COMP.	LARG.	ESP.	QTD.
1	313584	PAINEL LATERAL ESQUERDO	Left side panel	Panel lateral izquierdo	MDP	983	810	15	1
2	313585	TAMPO	Top	Parte superior	MDP	452	323	25	2
3	313586	LATERAL ESQUERDA NICHOS ESQUERDO	Left side Niche left	Lado izquierdo nicho a la izquierda	MDP	321	304	25	1
4	313587	TRAVESSA INFERIOR GAVETA	Drawer BOTTOM Rail	Riel inferior de cajón	MDP	403	72	15	2
5	313588	LATERAL DIREITA NICHOS ESQUERDO	Left niche right side	Nicho izquierdo lado derecho	MDP	600	304	15	1
6	313589	PAINEL LATERAL DIREITO	Right side panel	Panel lateral derecho	MDP	983	810	15	1
7	313590	LATERAL ESQUERDA NICHOS DIREITO	Left side niche right	Lado izquierdo nicho derecho	MDP	600	304	15	1
8	313591	LATERAL DIREITA NICHOS DIREITO	Right Side right Niche	Nicho derecho del lado derecho	MDP	321	304	25	1
9	313592	PAINEL	Panel	Panel	MDP	1440	538	15	2
10	313593	VISTA SUPERIOR	Top view	Vista superior	MDP	1440	88	15	1
11	313594	TRAVA PAINEL	Panel latch	Pestillo del panel	MDP	720	88	15	2
12	313595	FRENTE GAVETA	Drawer Front	Frente de cajón	MDP	420	148	15	4
13	700616	LATERAL GAVETA	Drawer side	Lado del cajón	MDP	300	100	12	8
14	313597	CONTRA FUNDO	Against background	Contra el fondo	MDP	354	88	12	4
15	313598	FUNDO GAVETA	Drawer Bottom	Fondo de cajón	HDF	374	300	3	4

Vista Superior / Upper View / Vista Superior

Vista Frontal / Front View / Vista Frontal

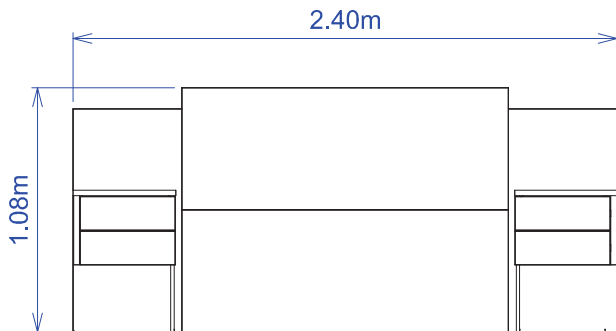

Dimensão do Produto: 2.40 x 1.08 x 0.34

INSTRUÇÃO MONTAGEM PRODUTO

Intructions to Assembly / Instrucciones de montaje

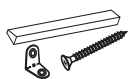

Separate as peças e acessórios de maneira organizada
Separate parts and accessories in way organized
Separe las piezas y accesorios de manera organizada

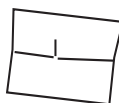

Forrar o chão com o papelão das embalagens.
Cover the floor with the cardboard
Cubra el suelo con la embalaje de cartón



É necessário 01 pessoa para montar o produto
01 person is required to assemble the product
Se requiere 01 persona para ensamblar el producto.

O produto deve ser a montado por um profissional qualificado
The product must be assembly by a professional
El producto debe ser ensamblado por un professional calificado

Ferramentas necessárias
(não fornecidas)

Not include tools / No herramientas



CUIDADO PARA CONSERVAÇÃO E LIMPEZA DO MÓVEL

Care to conservation and clean / Cuidados de limpieza

Peso máximo de carga informado refere-se a objetos distribuído de maneira uniforme sobre toda área de contato da peça



The maximum load weight informed refers to objects distributed evenly over the entire contact area of the part
Conjunto de carga máxima de peso se refere a objetos distribuídos uniformemente sobre toda el área de contacto de la pieza de trabajo.



Não molhar o móvel e não expor em lugar úmido
Do not wet the mobile and do not expose in a wet place
No moje el producto y no exponer en un lugar húmedo



Não expor o móvel próximo de fontes de calor.
Do not expose the mobile near heat sources
no esponga cercano de fuentes de calor



Não usar produtos abrasivos.
Do not use abrasive products.
No utilice productos abrasivos.



Limpe com flanela limpa e seca.
Clean with dry cloth
Limpieza con un paño limpio y seco

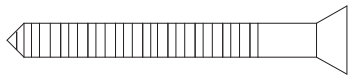

A-700137-PARAFUSO 4,5 X 45 10 UNID
Screw 4.5 X 45 / Tornillo 4.5 X 45

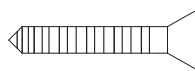

B-700124-PARAFUSO 3,5 X 25 44 UNID
Screw 3.5 X 25 / Tornillo 3.5 X 25



C-700121-PARAFUSO 3,5 X 12 56 UNID
Screw 3.5 X 12 / Tornillo 3.5 X 12

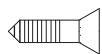

D-700120-PARAFUSO 3 X 12 PH 32 UNID
Screw 3.0 X 12 / Tornillo 3.0 X 12



E-700540-CANTONEIRA 16 UNID
Corner / Cantonera



F-700419-TAPA FURO 8 UNID
Slap Hole/Agujero de bofetada



G-700148-TAMBOR MINIFIX 8 UNID
Minifix Drum / Tambor Minifix



H-700146-PARAFUSO MINIFIX 8 UNID
Minifix screw / Tornillo minifix

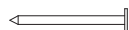

I-700157-PREGO 66 UNID
Nail/ Clavo



J-700433-SUPORTE ANGULAR 8 UNID
Angular support / Soporte angular



K-700448-MINI SAPATA L 10 UNID
Mini Hot Shoe / Mini zapato caliente



L-700113-CORREDICA 4 UNID
Telescopic slide / Corredica



M-700542-CAVILHA 32 UNID
Wood Bolts / Cuchillo de madera



N-700546-CHAPA DE FIXAÇÃO 2 UNID
Fixing plate /Placa de fijación

01° PASSO	Fixar peças 2, 3, 5 na peça 1, fixar peça 4 nas peças 3 e 5	02° PASSO	Fixar peças 10 e 11 nas peças 9
01° STEP	Fix Parts 2, 3, 5 in Part 1, fasten piece 4 in parts 3 and 5	02° STEP	Fix parts 10 and 11 in parts 9
01° PASO	Fije las piezas 2, 3, 5 en la parte 1, sujete la pieza 4 en las partes 3 y 5	02° PASO	Fijar las piezas 10 y 11 en las piezas 9
A		B	
C		K	
D		I	
E		M	
K			
I			
M		<p>Repetir processo nas peças 6, 7, 8, 9 Repeat process on parts 6, 7, 8, 9 Repetir el proceso en las partes 6, 7, 8, 9</p>	

B		
N		
C		
	<p>Ajustar distância entre os criados conforme a necessidade Adjust distance between the created as needed Ajuste la distancia entre la creada según sea necesario</p>	
	<p>Após conferido a distancia dos criados, fixar as peças x nas peças x After checking the distance of the servants, fix the parts x in the parts x Después de comprobar la distancia de los sirvientes, fije las partes x en las partes x</p>	

05° PASSO	Fixar peças 13 nas peças 12 e 14, fixar peça 15 nas peças 13 e 14	06° PASSO	Aspecto final do produto
05° STEP	Fasten parts 13 on parts 12 and 14, fasten piece 15 on parts 13 and 14.	06° STEP	Final product aspect
05° PASO	Fije las partes 13 en las partes 12 y 14, sujete la pieza 15 en las partes 13 y 14.	06° PASO	Aspecto final del producto
B			
G			
H			
I			
J			
L			
M			