

# MÖBLER<sup>®</sup>

*Sala*

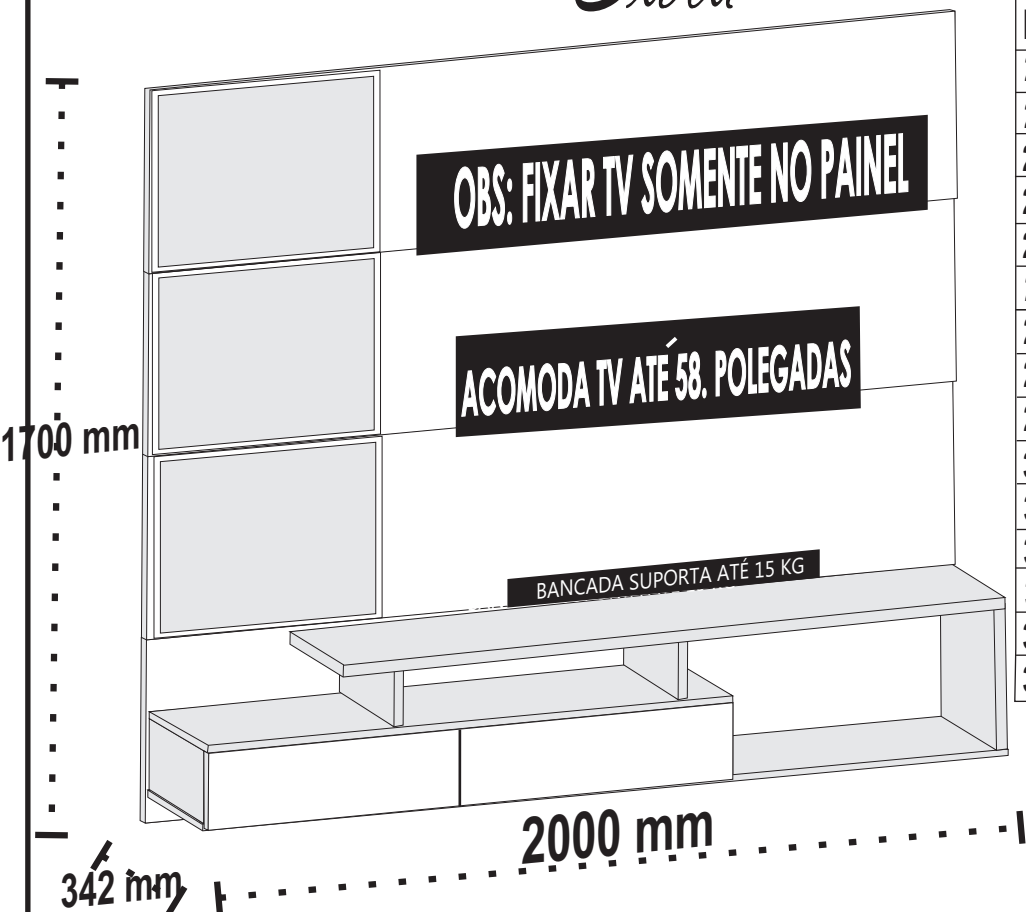

## Ficha técnica

### 2001103 - HOME DE PAREDE VENICE

N°	DESCRIÇÃO	CORES			Mat. Prima	MEDIDAS	Qtde.
		OFF WHITE NATURE	MADERO OFF WHITE	NATURE OFF WHITE		( mm )	
21	PAINEL INF.	567	699	700	MDP	2000 X 0425 X 12	01
22	PAINEL CENTRAL	567	699	700	MDP	2000 X 0425 X 12	01
23	PAINEL CEN. PASSA FIO	567	699	700	MDP	2000 X 0425 X 12	01
24	PAINEL SUP.	567	699	700	MDP	2000 X 0425 X 12	01
25	APOIO DO CAIXOTE	700	567	567	MDP	0285 X 0175 X 15	03
26	PORTA	567	699	700	MDP	0678 X 0188 X 15	02
27	REFORÇO DO PAINEL	----	----	----	MDF	1295 X 0100 X 25	02
28	CUNHA SUP.	----	----	----	MDP	1360 X 0100 X 25	02
29	LAT. DIR.	700	567	567	MDP	0283 X 0335 X 25	01
30	BASE INF.	700	567	567	MDP	1980 X 0285 X 15	01
31	TAMPO	700	567	567	MDP	1760 X 0285 X 25	01
32	APOIO	700	567	567	MDP	0283 X 0135 X 25	02
33	TAMPO DVD	700	567	567	MDP	1360 X 0305 X 25	01
34	CUNHA INF.	----	----	----	MDP	0425 X 0100 X 25	04
35	REFORÇO DO P.	----	----	----	MDP	0385 X 0100 X 25	03

#### LEGENDA DE CORES

567 - OFF WHITE

699 - MADERO

700 - NATURE















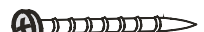

### 2001103 - HOME DE PAREDE VENICE

**702 - OFF WHITE - NATURE / 703 - MADERO - OFF WHITE / 704 - NATURE - OFF WHITE**





Parabens você acabou de adquirir um produto Belaflex. Você tem a sua disposição que há de melhor em qualidade e design.

Rua Floresta, N° 08 - Jardim Santa Terezinha - Fone ( 0\*\*43 ) 3242 - 8800 - Bela Vista do Paraíso - Paraná - [www.mobler.ind.br](http://www.mobler.ind.br)

# DESCRIÇÃO DE ACESSÓRIOS

Cód.	DESCRIÇÃO	Qtd.	DESENHO
<b>A</b>	PINO GIROFIX	09	
<b>B</b>	CASTANHA 15 mm	09	
<b>C</b>	TAMPA DA CASTANHA	09	
<b>D</b>	CAVILHA 6 X 30 mm	20	
<b>E</b>	PARAFUSO 3,5 X 12 mm	60	
<b>F</b>	PARAFUSO 4,0 X 35 mm	62	
<b>G</b>	PARAFUSO 4,0 x 50 mm	06	
<b>H</b>	PARAFUSO 5,0 X 70 mm	28	
<b>I</b>	BUCHA 8 mm	12	
<b>J</b>	PASSA FIO 40 mm	03	
<b>L</b>	SACHÊ DE COLA	05	
<b>M</b>	PINO DE PRAT. 8 X 12 mm	14	
<b>N</b>	CHAPINHA DUPLA 42 X 42	12	
<b>O</b>	DOBRADIÇA RETA C/ CALÇO 26	04	
<b>P</b>	PARAFUSO UNIÃO P/ DOBRADIÇA	08	
<b>Q</b>	ESPELHO 425X350X3 mm	03	
<b>R</b>	DUPLA FACE	18	

## 1º Passo

<b>A</b>	PINO GIROFIX	09		<b>C</b>	TAMPA DA CASTANHA	09	
<b>B</b>	CASTANHA 15 mm	09		<b>D</b>	CAVILHA 6 X 30 mm	18	
<b>G</b>	PARAFUSO 4,0 X 50 mm	04					

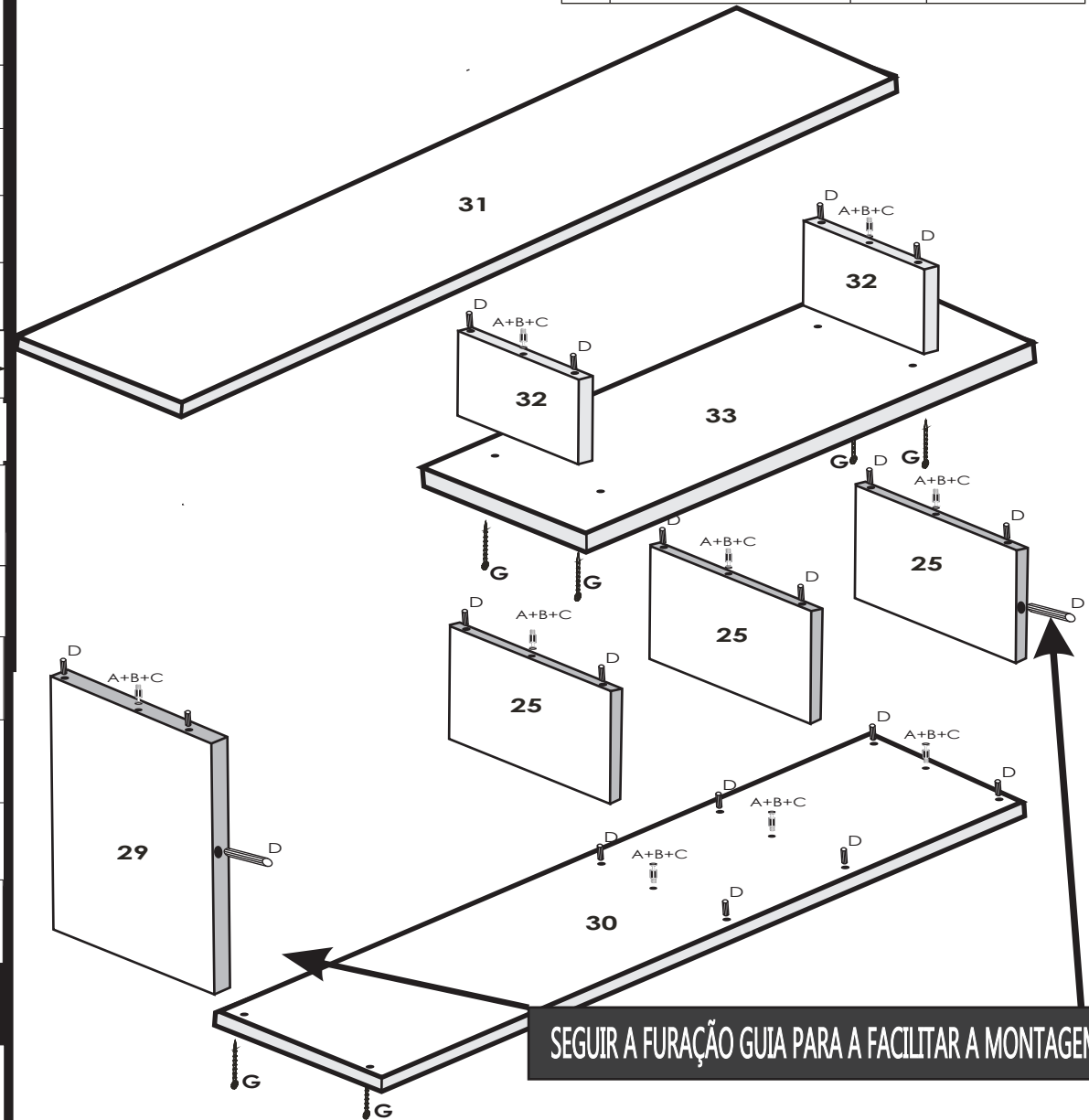

## 2º Passo

SEGUIR A MARCÃO PARA FACILITAR A MONTAGEM

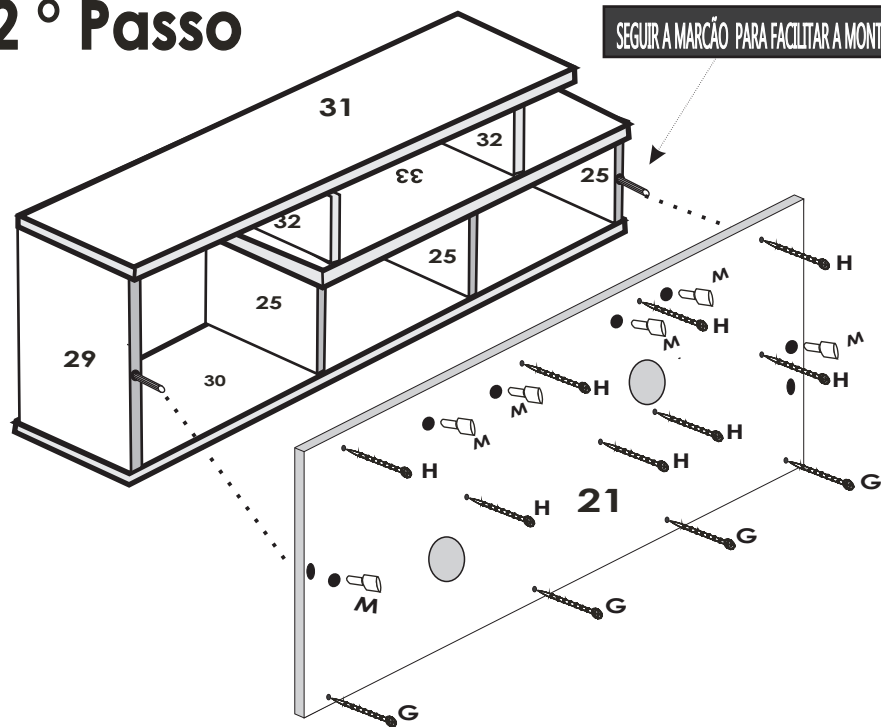

## 4º Passo

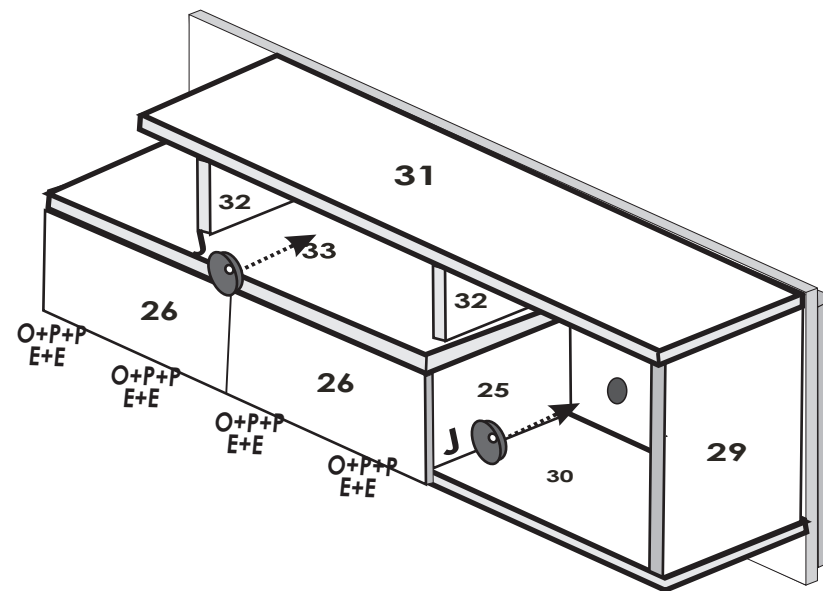

## 3º Passo

COLA L

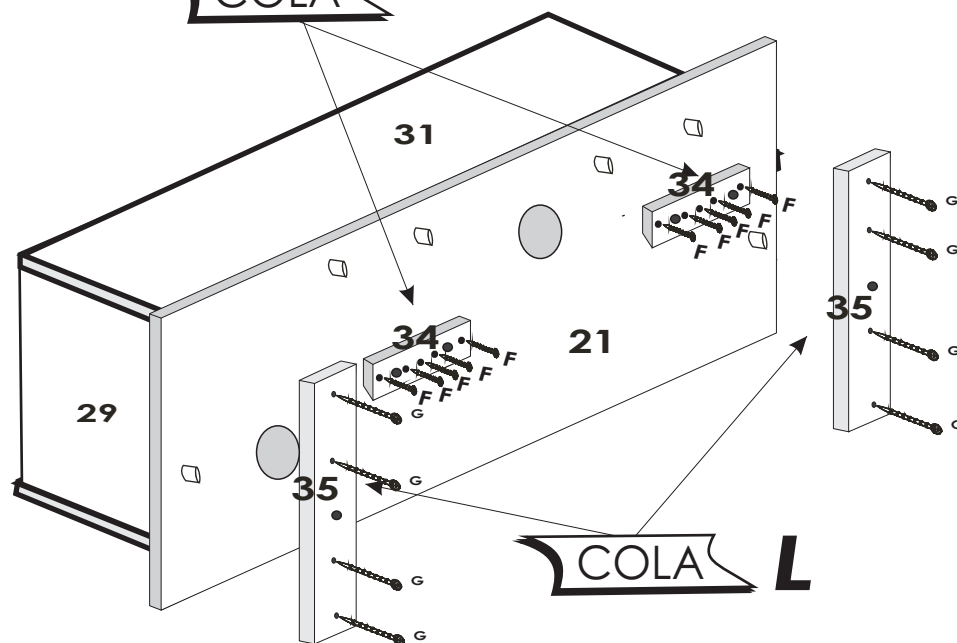

## 5º Passo



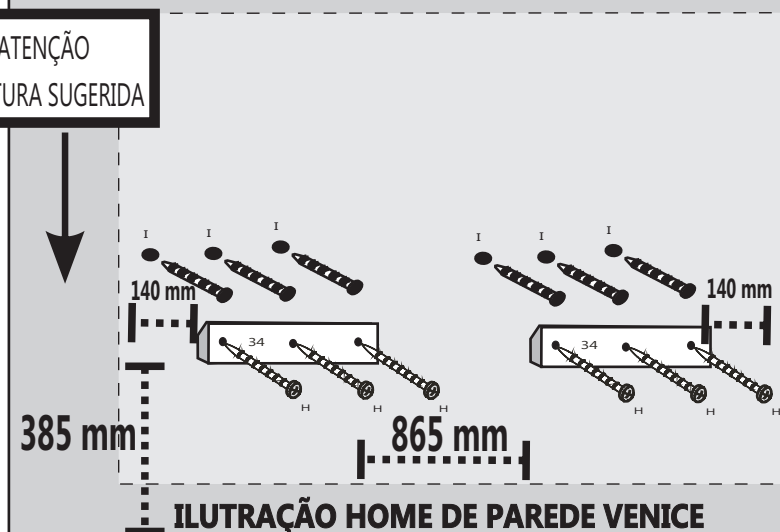

**OBS:**  
CARO MONTADOR FAVOR SEGUIR A MEDIDA INFORMADA  
NO DESENHO ABAIXO PARA FIXAÇÃO DAS PEÇAS Nº 34 E 34.

PAREDE

ATENÇÃO  
ALTURA SUGERIDA

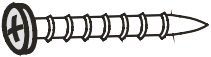

# 6º Passo

<b>E</b>	PARAFUSO 3,5 X 12 mm	<b>48</b>		<b>L</b> SACHÊ COLA	<b>03</b>		<b>N</b>	CHAPINHA DUPLA 42 X 42	<b>12</b>	
<b>F</b>	PARAFUSO 4,0 X 35 mm	<b>34</b>		<b>M</b> PINO DE PRAT. 8 X 12 mm	<b>10</b>					

**OBS:**

- 1 - ABRIR A PRÓPRIA EMBALAGEM FERRAR O CHÃO COM PAPELÃO, DEPOIS COMEÇAR O PROCESSO DE MONTAGEM DO PAINEL.
- 2 - UTILIZAR A PEÇA N° 27 PARA ALINHAR CONFORME O DESENHO AS PEÇAS N° 22,23,24.
- 3 - UNIR AS PEÇAS N° 22,23,24 COM ACESSÓRIO LETRA ( E + N ).
- 4 - COLAR A PEÇA N° 27,28,27 NAS PEÇAS N° 22,23,24, DEPOIS FIXAR COM O ACESSÓRIO F.

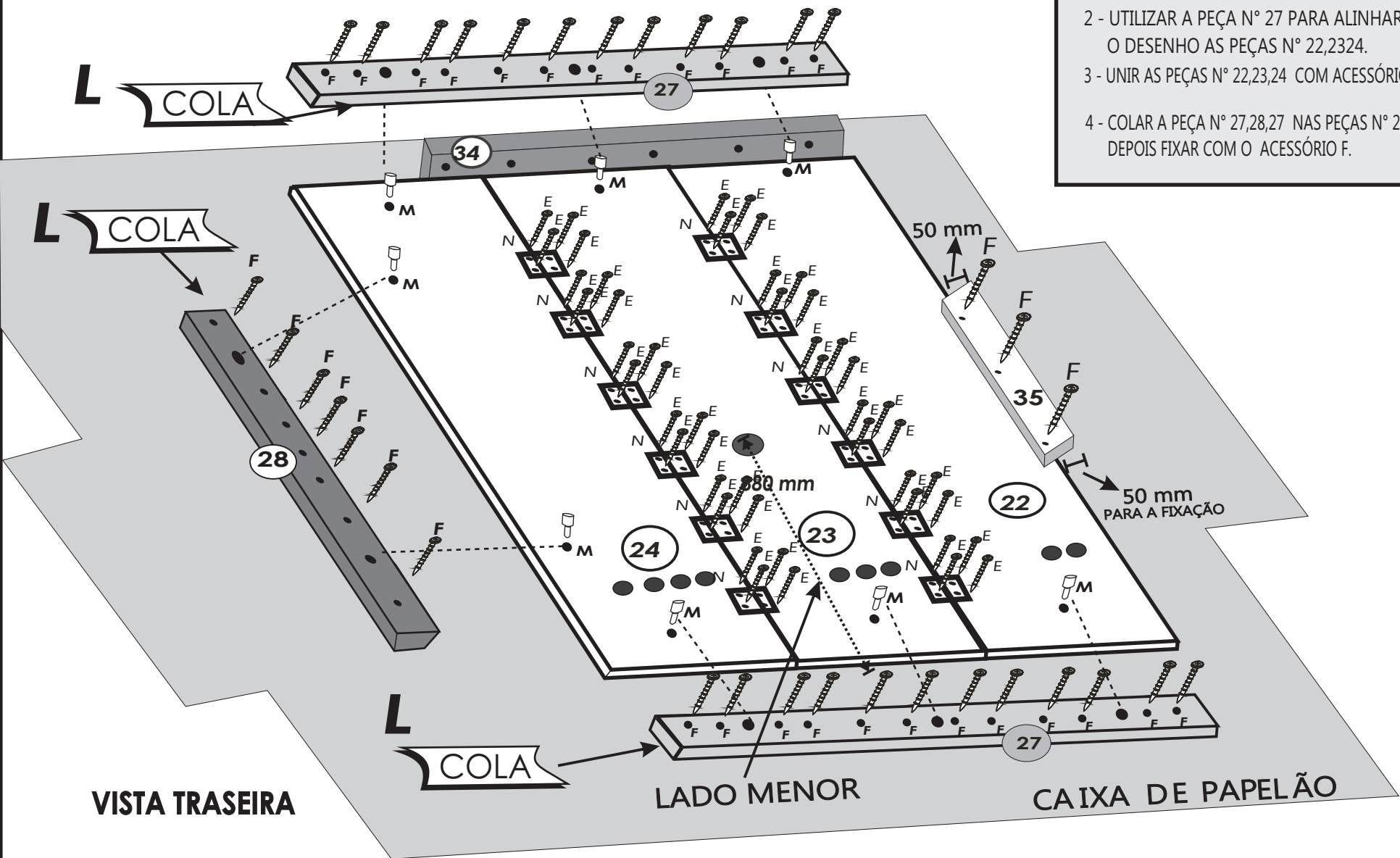



VISTA TRASEIRA

LADO MENOR

CAIXA DE PAPELÃO

## 7º Passo

H	PARAFUSO 5,0 X 70 mm	06	
I	BUCHA 8 mm	06	

### OBS:

CARO MONTADOR FAVOR SEGUIR A MEDIDA INFORMADA NO DESENHO ABAIXO PARA FIXAÇÃO DA PEÇA Nº28.

ATENÇÃO  
ALTURA SUGERIDA

PAREDE



ILUSTRAÇÃO HOME DE PAREDE VENICE

## 8º Passo

ATENÇÃO!!!!

- 1 - FIXAR A BANCADA INFERIOR CONFORME AS ILUSTRAÇÕES
- 2 - ENCAIXAR O PAINÉIS CONFORME O DESENHO ABAIXO.

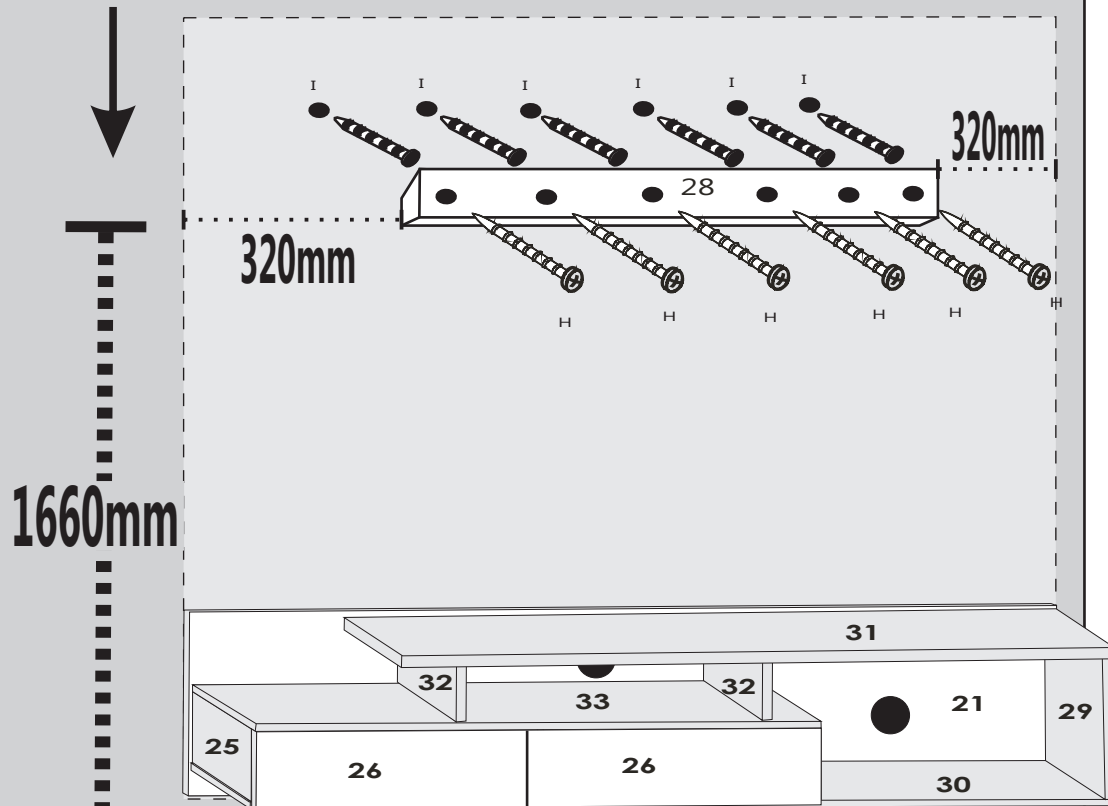
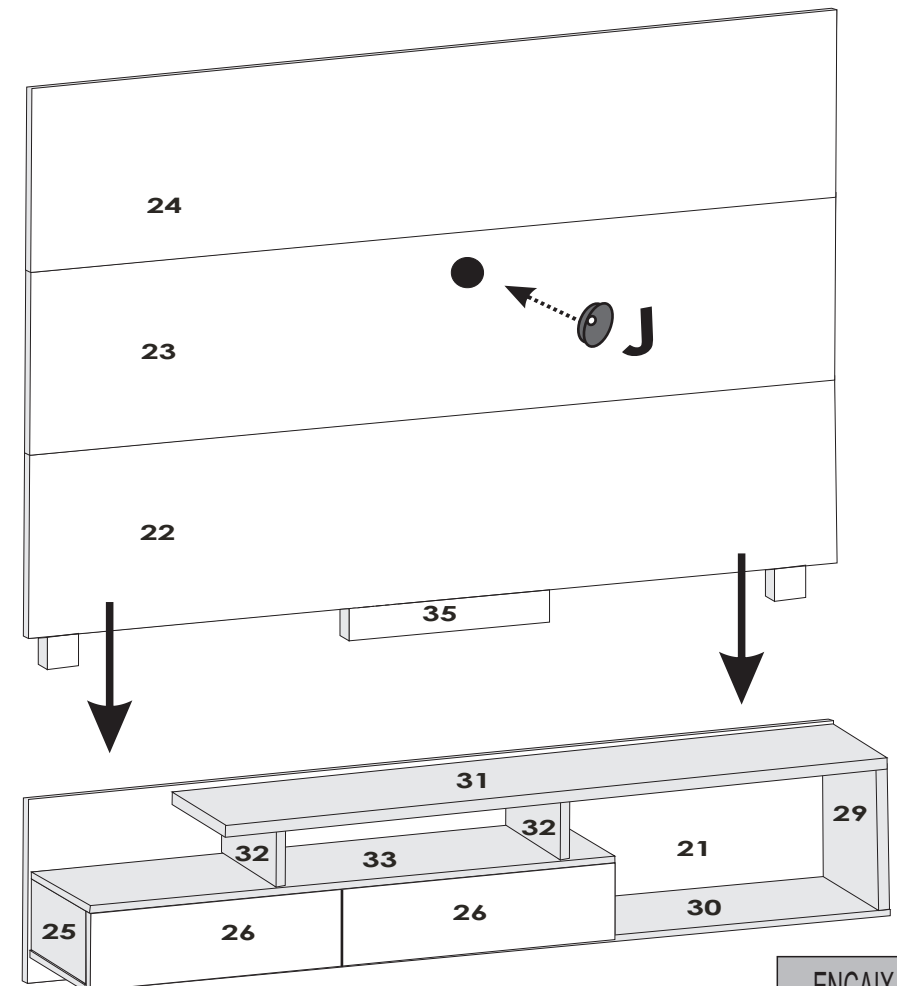

ENCAIXAR  
PASSA FIO



# 9 ° Passo

## OBS:

- 1 - PARA FACILITAR A COLAGEM DOS ESPELHOS, COLE AS DUPLAS FACES ( R ) NO ESPELHO ( Q ).
- 2 - DEPOIS COLE NOS PAINÉIS N° 24,23,22.  
CONFORME A ILUSTRAÇÃO.

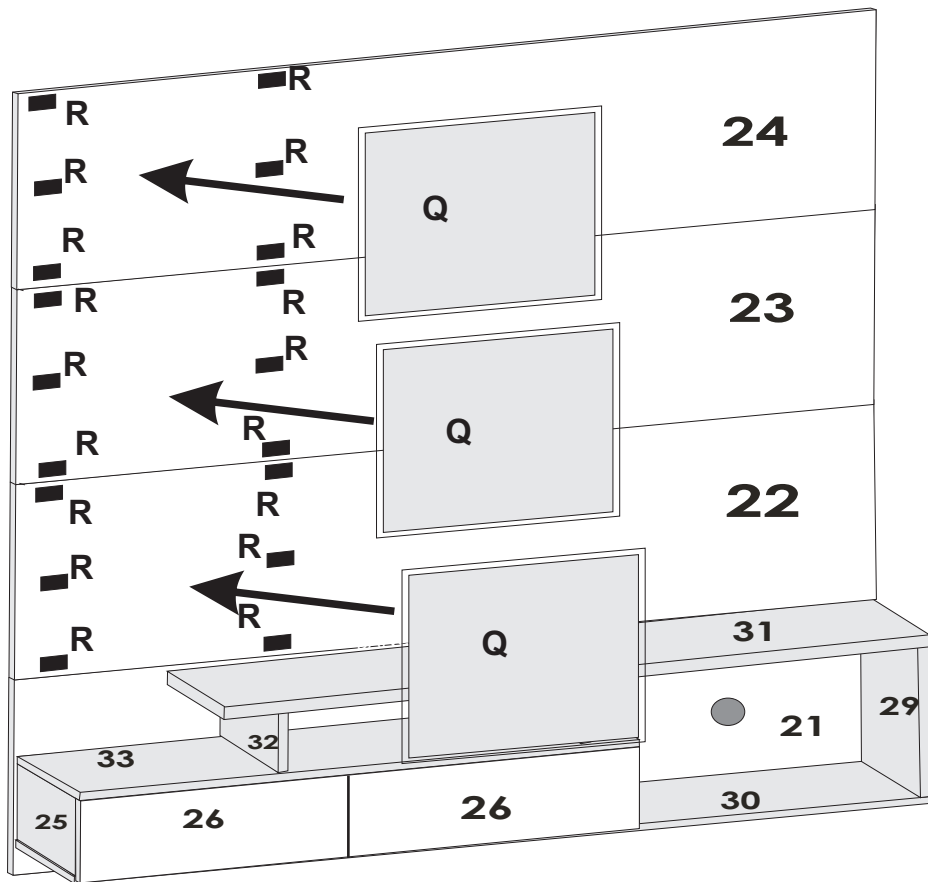

# 10 ° Passo

