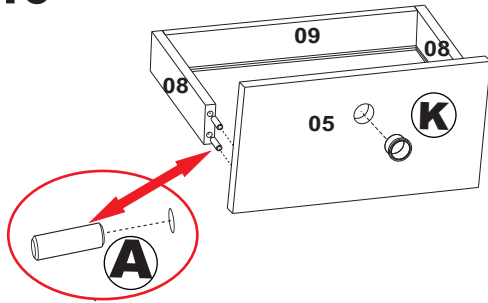
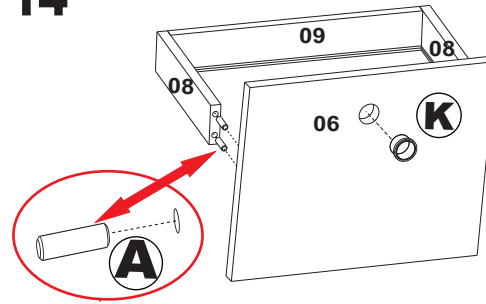
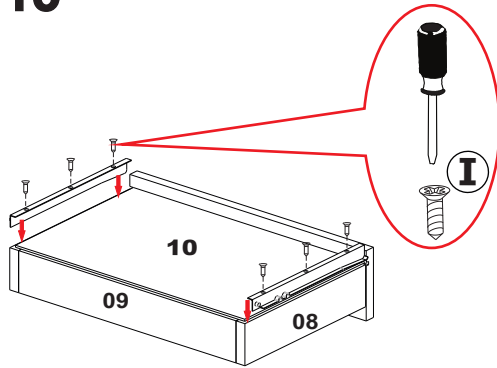
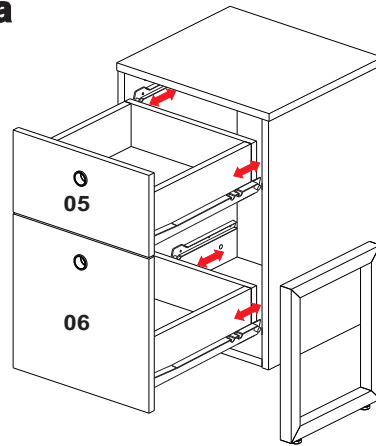
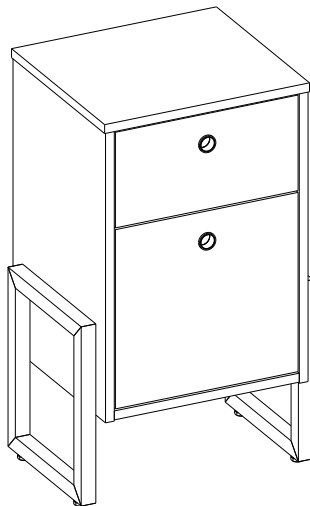

13^a14^a15^a16^a17^a

CRIADO / CREATED / MESILLA DE NOCHE

FITMOBEL

CRIADO WOLLI

COM GAVETA / WITH DRAWERS / CON CAJONES

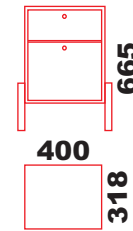
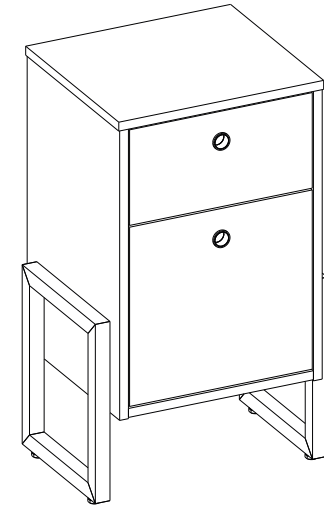

Parabéns pela aquisição de um produto de qualidade.
 Em caso de dúvidas procure a loja em que efetuou a compra .
Congratulations on your purchase of a product of quality.
 When in doubt look for the shop where you made the purchase.
Enhorabuena por la compra de un producto de calidad.
 En caso de duda buscar la tienda donde hizo la compra.

Montador

Observe atentamente as instruções e siga rigorosamente as etapas de montagem.
 Após a montagem entregue ao cliente para a garantia do produto

Assembler

Note the instructions carefully and strictly follow the assembly steps.
 After assembly delivered to the customer for the product warranty

Ensamblador

tenga en cuenta las instrucciones cuidadosamente y seguir estrictamente los pasos de montaje.
 Después del montaje entregado al cliente para la garantía del producto

Observações:

- Para limpeza utilize pano seco.
- Não utilize álcool ou produtos químicos tipo limpeza pesada, bem como produtos abrasivos.
- Pouca resistência à umidade.
- 3 meses de garantia legal contra eventuais defeitos de fabricação .
- Não é coberto pela garantia. Danos referentes ao mal uso do produtos.

Resistência

-20KG.

Comments:

- For cleaning only dry cloth.
- Do not use alcohol or heavy-duty cleaning chemicals as well as abrasive products.
- Low resistance to humidity

Warranty

- 3 months of legal warranty against any manufacturing defects.
 It is not covered by warranty . Damages for the use of the product .

Resistance

-20kg

Observaciones:

- Para La limpieza utilice paño seco.
- No utilice alcohol ni productos químicos como la limpieza pesada y productos abrasivos
- Poca resistencia a la humedad lo hará

Garantía













- 3 meses de garantía legal contra cualquier defecto de fabricación .
 No está cubierto por la garantía . Los daños para el uso del producto.

Resistencia

-20kg

Montagem / Assembly / Montaje









Acessórios / Accessories / Accesorios

A Cavilha Pin Clavija 24 	B Tambor Cam lock 08 	C Girofix 08 	D Bucha sapata Shoe bushing Buje de zapata 04 
E Sapata Shoe Zapato 04 	F Parafuso PA PH MQ6,0X30 Screw Tornillo 08 	G Tapa furo 08 	H Corrediças Slide Corredera 02par 
I Parafuso CH PH SB 3,5X12 Screw Tornillo 24 	J Prego Nail Clavo 10 	K Puxador 02 	L Sache de cola Sache glue Bolsita pegamento 02 

Ferramentas / Tools /
Herramientas

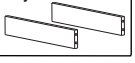

Peças / Parts / Partes

01 Tampo Top Tapa 01 	02 Base 01 	03 Lateral Side Lado 02 
04 Fundo Funds Fondo 01 	05 Frente de gaveta Drawer front Frente de cajón 01 	06 Frente do gavetão Drawer front Frente de la gavetón 01 
07 Pé lateral Lateral foot Pie lateral 02 	08 Lateral da gaveta Side drawer Cajón lateral 04 	09 Contra fundo Against fund Contra el fondo 02 
10 Fundo gaveta Drawer bottom Fondo del cajón 02 		

Instrução / instruction/ instrucciones

Antes de montar, confira todos os componentes e acessórios de acordo com a lista.
Forre o chão com papelão ou tecido.
Evite batidas nas peças ou entre elas para evitar riscos ou danos às estruturas.

Before mounting, check all components and accessories according to the list.
Paper or cardboard with the ground fabric.
Avoid tapping on the parts or between them to avoid scratches or damage to structures.

Antes del montaje, compruebe todos los componentes y accesorios de acuerdo a la lista.
Papel o cartón con el tejido de fondo.
Evitar tocar en las partes o entre ellos para evitar arañazos o daños a las estructuras.

