

# belaflex®

## MÓVEIS

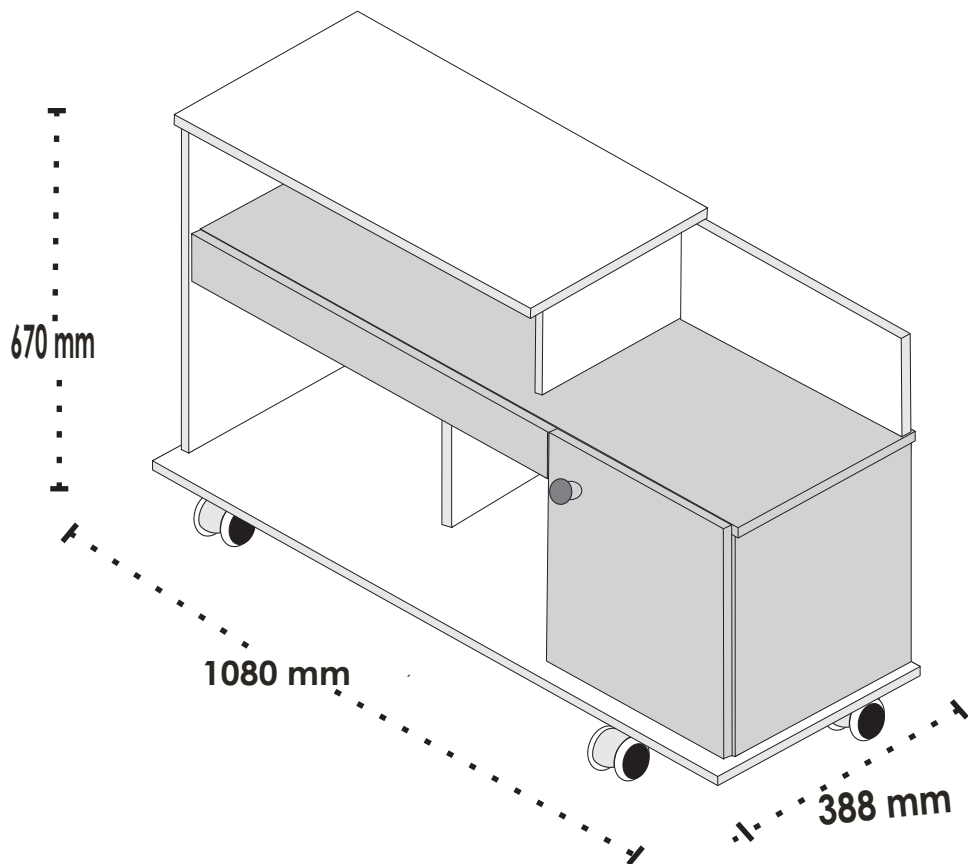

### Ficha técnica

## 1005048 - RACK FLASH

Nº	DESCRIÇÃO	CORES			Mat. Prima	MEDIDAS ( mm )	Qtde.
		MALTE	CARV. VIENA MALTE	MALTE CARV. VIENA			
01	FUNDO MAIOR	574	575	574	MDF	0335 X 0405 X 03	03
21	TAMPO	574	575	574	MDP	0680 X 0360 X 15	01
22	TAMPO INFERIOR	574	574	575	MDP	1010 X 335 X 15	01
23	BASE	574	575	574	MDP	1080 X 0385 X 15	01
24	LATERAL ESQ.	574	575	574	MDP	0570 X 0358 X 15	01
25	DIVISÓRIA SUP.	574	575	574	MDP	0170 X 0300 X 15	01
26	DIVISÓRIA INF.	574	575	574	MDP	0385 X 0225 X 15	01
27	LAT. ESQ. PORTA	574	574	575	MDP	0385 X 333 X 15	01
28	LAT. DIR. PORTA	574	574	575	MDP	0385 X 333 X 15	01
29	VISTA PRATELEIRA	574	574	575	MDP	0660 X 080 X 15	01
30	PAINEL TRASEIRO	574	575	574	MDP	0420 X 170 X 15	01
31	PORTA	574	574	575	MDP	0394 X 330 X 15	01

### LEGENDA DE CORES

574 - MALTE

575 - CARVALHO VIENA

### 1005048 - RACK FLASH

574 - MALTE / 580 - CARVALHO VIENA - MALTE / 581 - MALTE - CARVALHO VIENA

Parabens você acabou de adquirir um produto Belaflex. Você tem a sua disposição que há de melhor em qualidade e design.

Rua Floresta, Nº 08 - Jardim Santa Terezinha - Fone ( 0\*\*43 ) 3242 - 8800 - Bela Vista do Paraíso - Paraná - www.belaflex.ind.br

# DESCRIÇÃO DE ACESSÓRIOS

Cód.	DESCRIÇÃO	Qtd.	DESENHO
<b>A</b>	PINO GIROFIX	18	
<b>B</b>	CASTANHA 15 mm	18	
<b>C</b>	TAMPA DA CASTANHA	10	
<b>D</b>	CAVILHA 6 X 30 mm	22	
<b>E</b>	PARAFUSO 3,5 X 14 mm	26	
<b>F</b>	PARAFUSO 4,0 x 25 mm	05	
<b>G</b>	PARAFUSO 3,0 X 30 mm	02	
<b>H</b>	CHAPINHA DE FUNDO	04	
<b>I</b>	PREGO 8 X 8	42	
<b>J</b>	DOBRADIÇA C/ CALÇO 03 mm	02	
<b>K</b>	CHAPINHA DUPLA	01	
<b>L</b>	PUXADOR BARI	01	
<b>M</b>	CANTONEIRA CIOBA	04	
<b>N</b>	RODIZIO SEM TRAVA	04	



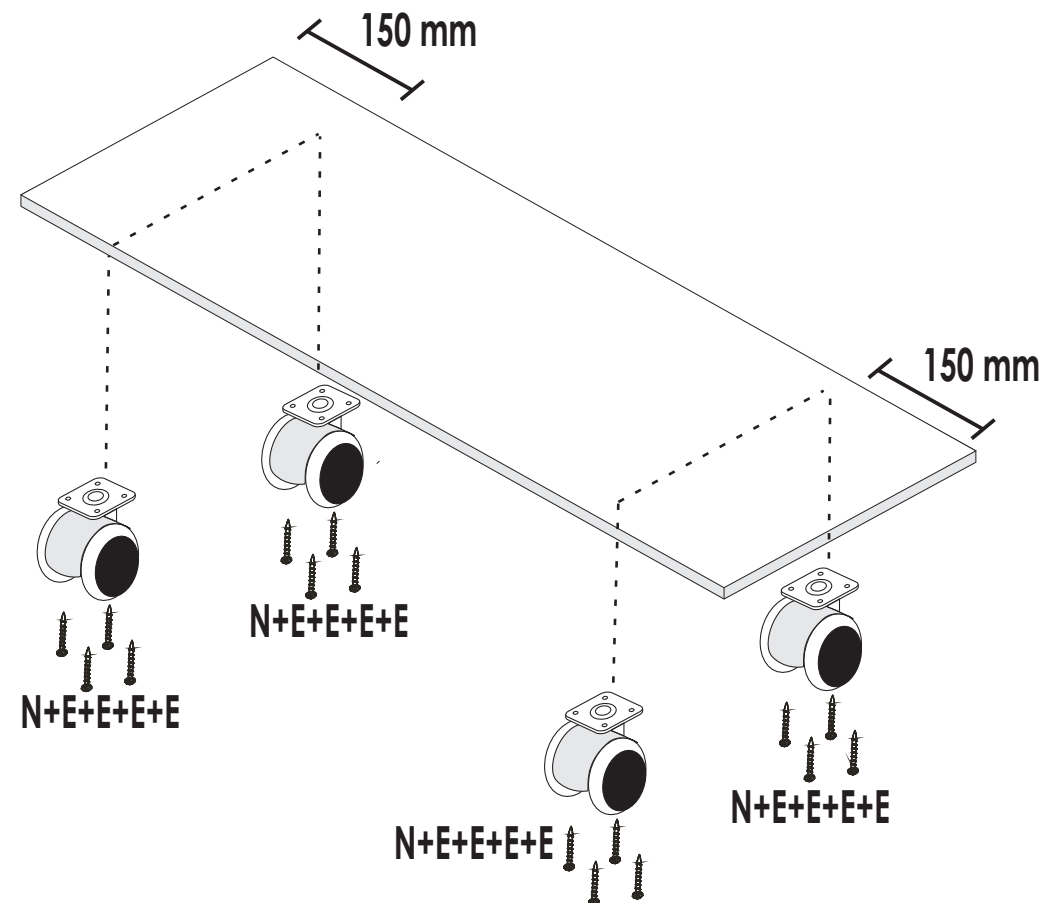

## 1º Passo

<b>E</b>	PARAFUSO 3,5 X 14 mm	16		<b>N</b>	RODIZIO SEM TRAVA	04	
----------	----------------------	----	---	----------	-------------------	----	---

OBS: SEGUIR A DISTÂNCIA PARA FIXAÇÃO DOS RODIZIO ACESSÓRIO LETRA **N**







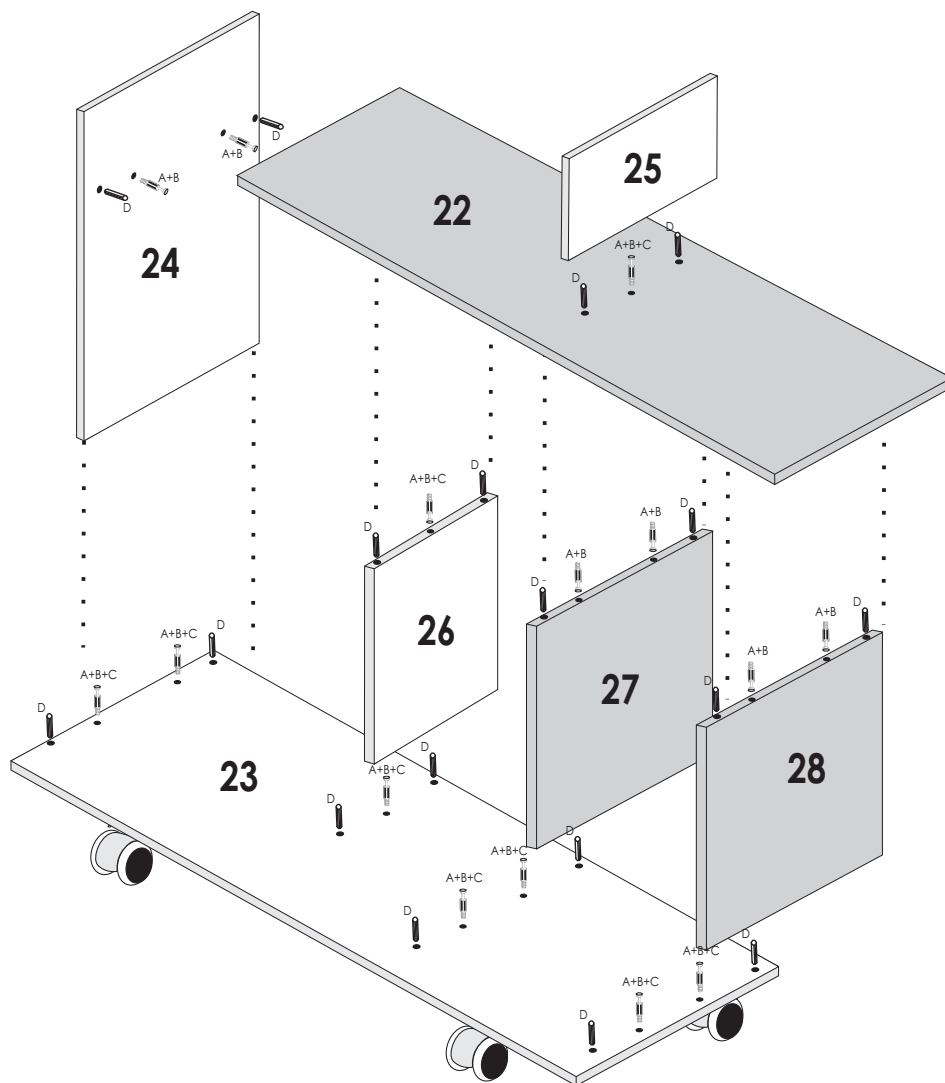

## 2º Passo

<b>A</b>	PINOIROFIX	15		<b>C</b>	TAMPA DA CASTANHA	09	
<b>B</b>	CASTANHA 15 mm	15		<b>D</b>	CAVILHA 6 X 30 mm	18	

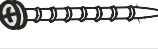

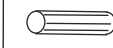
## 3º Passo



<b>A</b>	PINOIROFIX	03		<b>E</b>	PARAFUSO 3,5 X 14 mm	08	
<b>B</b>	CASTANHA 15 mm	03		<b>F</b>	PARAFUSO 4,0 X 25 mm	05	
<b>C</b>	TAMPA DA CASTANHA	01		<b>J</b>	DOBRADIÇA C/ CALÇO 3 mm	02	
<b>D</b>	CAVILHA 6 X 30 mm	04		<b>L</b>	PUXADOR BARI	01	
<b>N</b>		CANTONEIRA CIOBA	04				

### OBS:

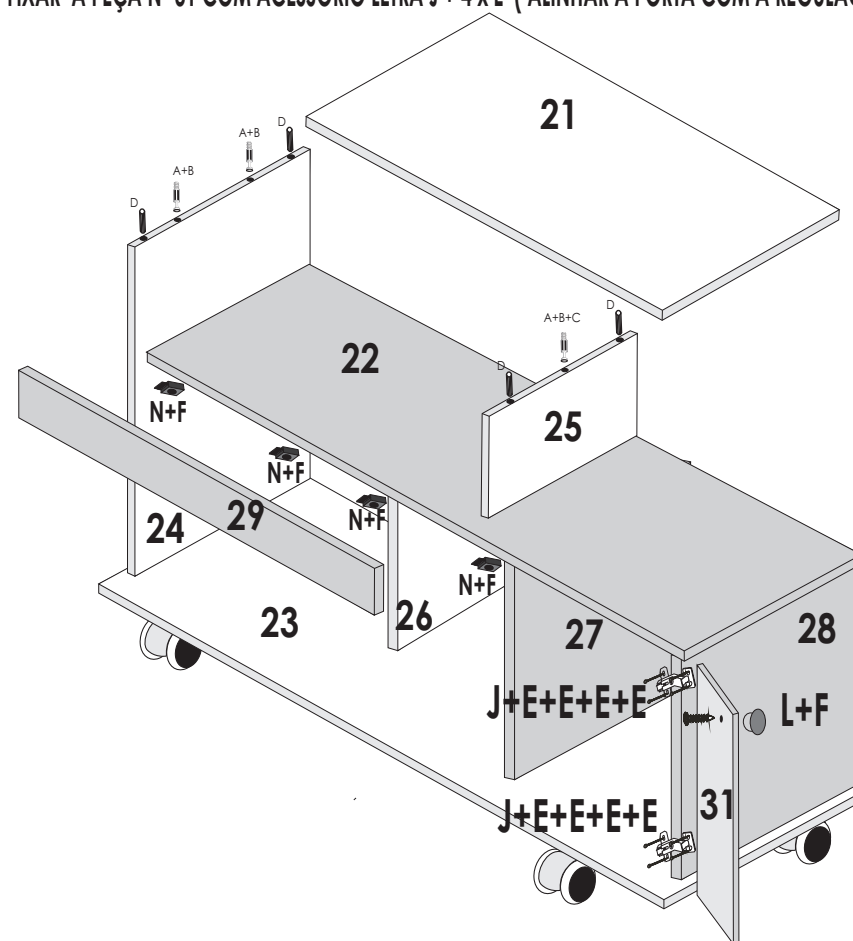
- 1 - FIXAR O ACESSÓRIO LETRA N NA PEÇA Nº 29.
- 2 - ALINHAR A PEÇA Nº 29 NA POSIÇÃO DESEJADA, FIXAR O ACESSÓRIO LETRA N + F NA PEÇA Nº 22.
- 3 - FIXAR A PEÇA Nº 31 COM ACESSÓRIO LETRA J + 4 x E (ALINHAR A PORTA COM A REGULAGEM DA DOBRADIÇA).



## 4º Passo

<b>E</b>	PARAFUSO 3,5 X 14 mm	12		<b>K</b>	CHAPINHA DUPLA	01	
<b>G</b>	PARAFUSO 3,0 x 30 mm	02					

### OBS:

- 1 - ALINHAR A PEÇA Nº 30 ENCAIXANDO COM AS PEÇAS Nº 22 E 25 NA POSICIONANDO CONFORME A ILUSTRAÇÃO ABAIXO.
- 2 - UTILIZAR O ACESSÓRIO LETRA ( 2 x G ) PARA A FIXAÇÃO DA PEÇA Nº 22 E 30.
- 3 - UTILIZAR O ACESSÓRIO LETRA ( K + 2x E ) PARA A FIXAÇÃO DA PEÇA Nº 30 E 21.

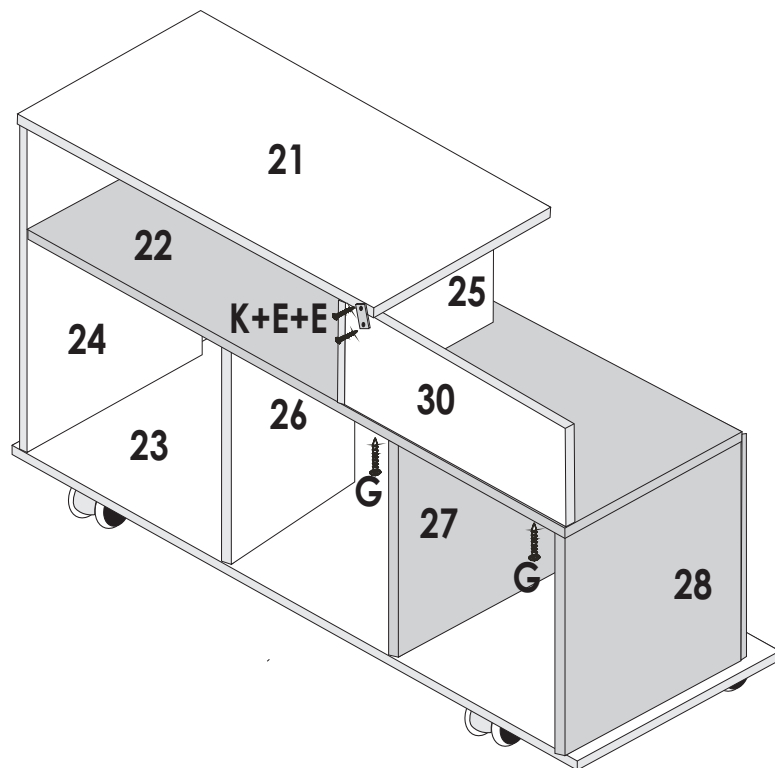

## 5º Passo

<b>H</b>	CHAPINHA DE FUNDO	04	
<b>I</b>	PREGO 8 X 8 mm	42	