

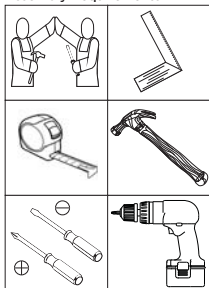

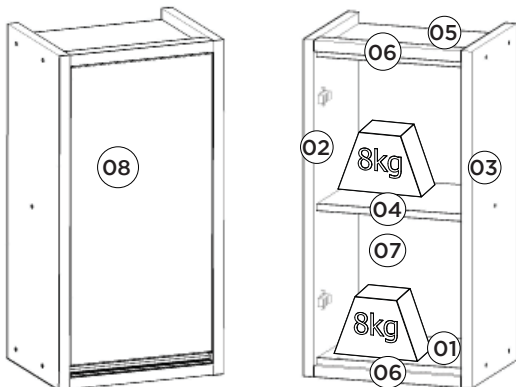







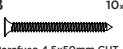
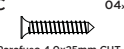
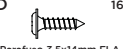

HENNInd. e Com. de Móveis Henn
Mondai - SC - Brasil

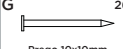
☎ +55 49 3674.3500

📱 @moveishenn
www.henn.com.br**INSTRUÇÕES DE MONTAGEM****INSTRUCCIONES DE MONTAJE
ASSEMBLY INSTRUCTIONS****Aéreo 01 Porta 400mm Lyra | Aéreo 01 Puerta 400mm Lyra | Aerial 01 Door 400mm Lyra****Referência/Cor****c C459-108 Duna/Off White****Requisitos para montagem
Requisitos para la montaje
Assembly Requirements****Imagens meramente ilustrativas
Imágenes meramente ilustrativas
Images for illustration only****Pesos máximos recomendados com carga distribuída
Peso máximo recomendado con la carga distribuída
Recommended maximum weight with distributed load.****Lista de Peças | Lista de piezas | List of parts**

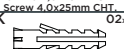
| Item | Caixa Caja Box | Qtd Ctd Qty | Descrição Descripción Description | Medidas (mm) Dimensions (mm) Size (measurements) (mm) |
|------|----------------------|-------------------|--|---|
| 01 | 1/1 | 01 | Base Base Base | 350x295x15 |
| 02 | 1/1 | 01 | Lateral Esquerda Lateral Izquierda Left Side | 780x312x25 |
| 03 | 1/1 | 01 | Lateral direita Lateral derecha Right side | 780x312x25 |
| 04 | 1/1 | 01 | Prateleira Estante Shelf | 350x295x15 |
| 05 | 1/1 | 01 | Tampo Tapa Top | 350x295x15 |
| 06 | 1/1 | 02 | Moldura Inferior Superior Marco Inferior superior Top Bottom Frame | 350x37x25 |
| 07 | 1/1 | 01 | Fundo Fondo Bottom | 722x380x3 |
| 08 | 1/1 | 01 | Porta Puerta Door | 697x344x15 |

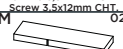
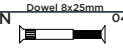
Ferragens | Herrajes | Hardware

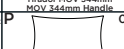
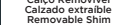
| | | | | | | | |
|--|---|--|--|--|---|---|--|
|  Parafuso 5,0x50mm FLA. Tornillo 5,0x50mm FLA. Screw 5,0x50mm FLA. |  Parafuso 4,5x50mm CHT. Tornillo 4,5x50mm CHT. Screw 4,5x50mm CHT. |  Parafuso 4,0x25mm CHT. Tornillo 4,0x25mm CHT. Screw 4,0x25mm CHT. |  Parafuso 3,5x14mm FLA. Tornillo 3,5x14mm FLA. Screw 3,5x14mm FLA. |  Parafuso 3,5x12mm CHT. Tornillo 3,5x12mm CHT. Screw 3,5x12mm CHT. |  Cavilha 8x25mm Cinta 8x25mm Dowel 8x25mm |  Prego 10x10mm Clavo 10x10mm Nail 10x10mm |  Puxador MOV 344mm Tirador MOV 344mm MOV 344mm Handle |
|  Calço Removível Calzado extraíble Removable Shim |  Borrachada SlideOn Super Alta Amort. 35mm Bisagra Super High Amort Slings. 35mm |  Bucha plástica 8mm Bucha de plástico 8mm 8mm plastic bushing |  Suporte de fixação Soporte de fijación Mounting bracket |  Proteção para cantoneira Angulo de protección Protection angle |  Parafuso União 50mm Tornillo Unión 50mm Union Screw 50mm |  Giz de correção Tiza de corrección Chalk of correction |  Sachê de cola Bolsa de pegamento Glus bag |
|  Adesivo tampa parafuso 10mm Adhesivo tapón de tornillo 10mm Bolt cover adhesive 10mm | | | | | | | |

O parafuso (N) deve ser usada somente quando este módulo for acoplado a outro módulo componível Henn.

El tornillo (N) se debe utilizar sólo cuando el módulo está conectado a otro módulo componible Henn.

The screw (N) should be used only when this module is attached to another Henn modular module.

RECOMENDAÇÃO

Para fixar o móvel na parede usar o suporte de fixação (L), o parafuso 3,5x14mm FLA (D), a Bucha 8mm (K) e o parafuso 5,0x50mm FLA (A).

RECOMENDACIÓN

Para conectar el móvil a la pared con el soporte (J), tornillo 3,5 x14mm FLA (C), el casquillo de 8 mm (I) y el 5,0 x50mm tornillo FLA (A).

RECOMMENDATION

To fix the furniture to the wall use the fixing bracket (J), the 3.5x14mm FLA (C) screw, the 8mm bushing (I) and the 5.0x50mm FLA screw (A).

1º

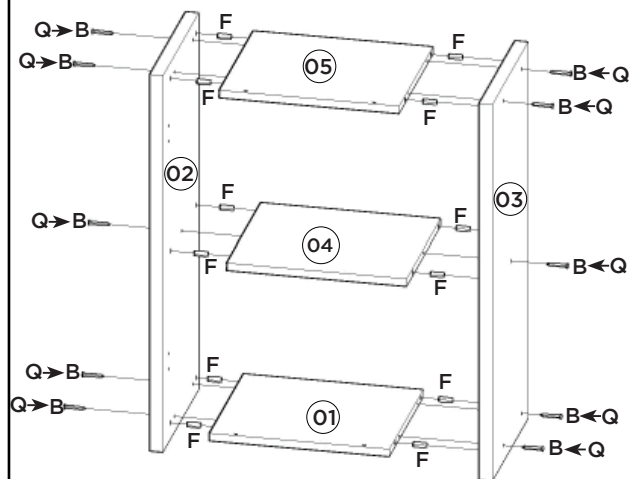

Utilizar o sachê de cola (P) em todas as cavilhas (F) do produto.

Con el pegamento sobre (P) en todos los pernos (F) producto.

Use the glue sachet (P) on all of the pegs (F) of the product.

AVISO

Para limpeza de seu móvel, use uma flanela seca ou umedecida, e não utilize produtos químicos que possam danificar seu produto.

SISTEMA DE MONTAGEM

O sistema de montagem dos produtos, funciona de acordo com a ordem crescente dos números indicados no desenho. Ex: 01, 02, 03, 04... até a conclusão da montagem.

ADVERTENCIA

Para limpieza de su móvil, use una franela seca o húmeda, y no utilice productos químicos que puedan dañar su producto.

SISTEMA DE MONTAJE

El sistema de montaje de los productos funciona de acuerdo con el orden creciente de los números indicados en el dibujo. Ej.: 01, 02, 03, 04... hasta la conclusión del montaje.

2º

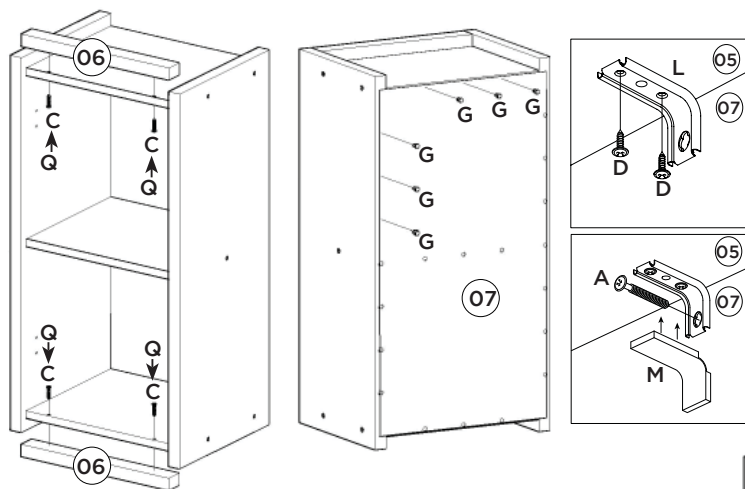

NOTICE

To clean your furniture, use a dry or wet cloth, and do not use chemicals that may damage your product.

ASSEMBLY SYSTEM

The products' assembly system works according to the increasing order of the indicated numbers. For example: 01, 02, 03, 04 ... to the end of the assembly.

3º

