







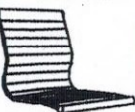

ASSEMBLY

INSTRUCTION

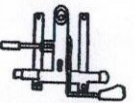
MODEL: OR-3301 Baixa

① CASTOR	③ GASLIFT
	
5PCS	1PC
② 5-STARBASE	④ BACK AND SIT
	
1PC	1PC
⑤ WASHER	⑦ MECHANISM
	
4PCS	
⑥ ALLENKEY	
	
M8 1PC	1PC
⑧ SCREW	⑩ ARMREST
M8*14	
	
4PCS	
⑨ SCREW	
M8*45	
	
4PCS	1PC

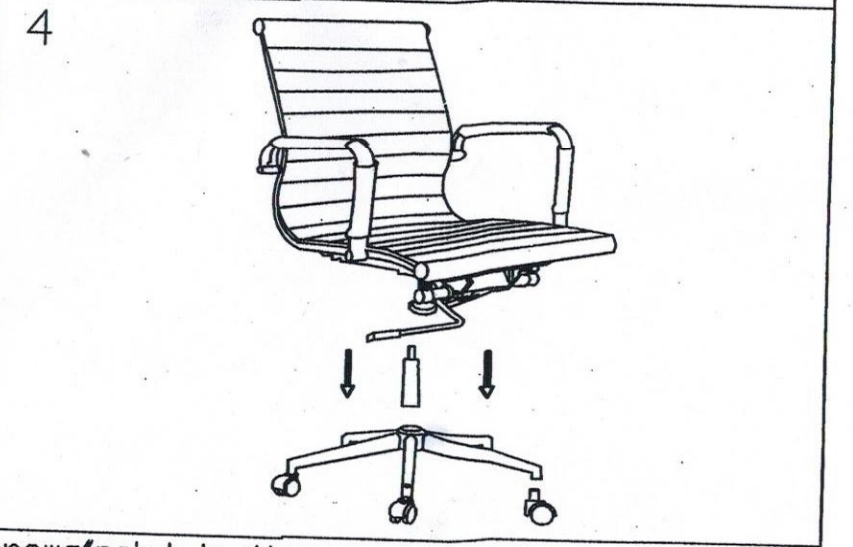
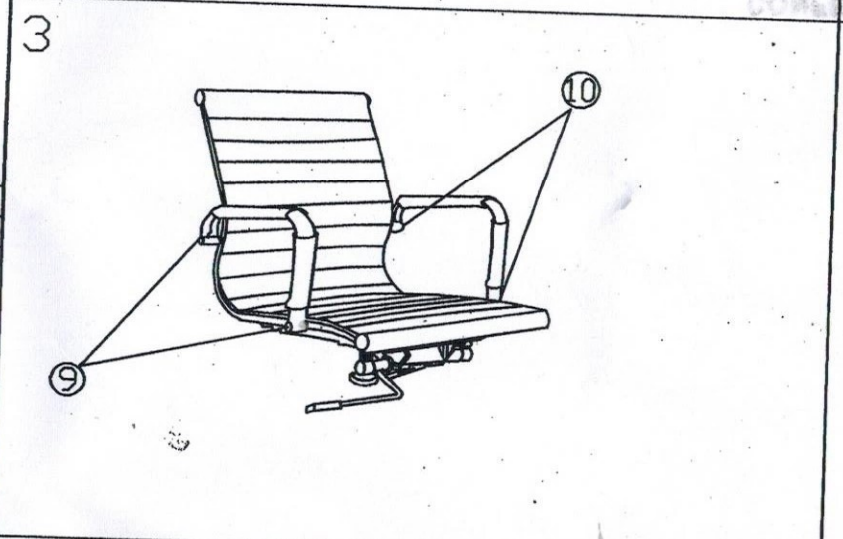
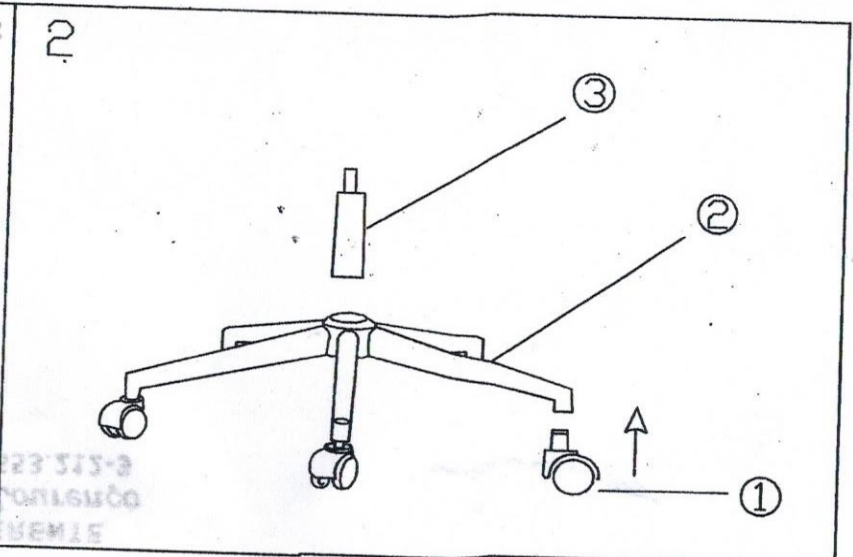
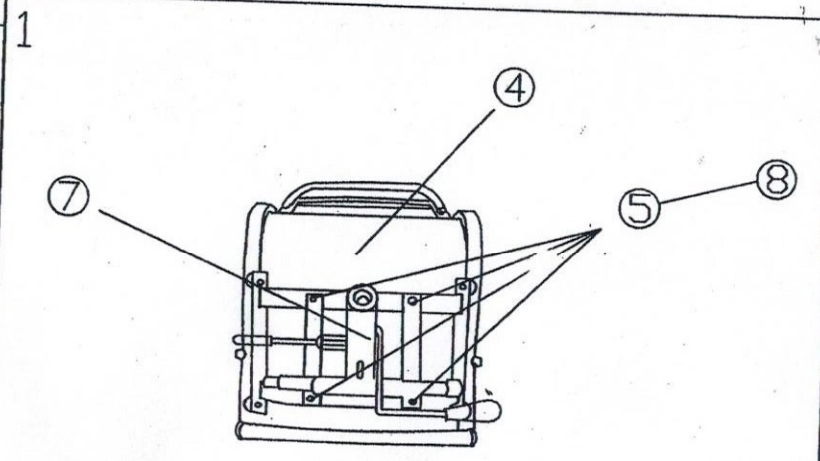

It is import to assemble all parts so that the directional "Arrows" point in the same direction. Make certain that all screws are fully tightened before using the chair, each month check all screws and tighten and that may have loosened. warning: Do not stand on the chair for any purpose