

RP2630 ROUPEIRO

Manual de Montagem
 Assembly Instructions
 Instrucción de Montaje

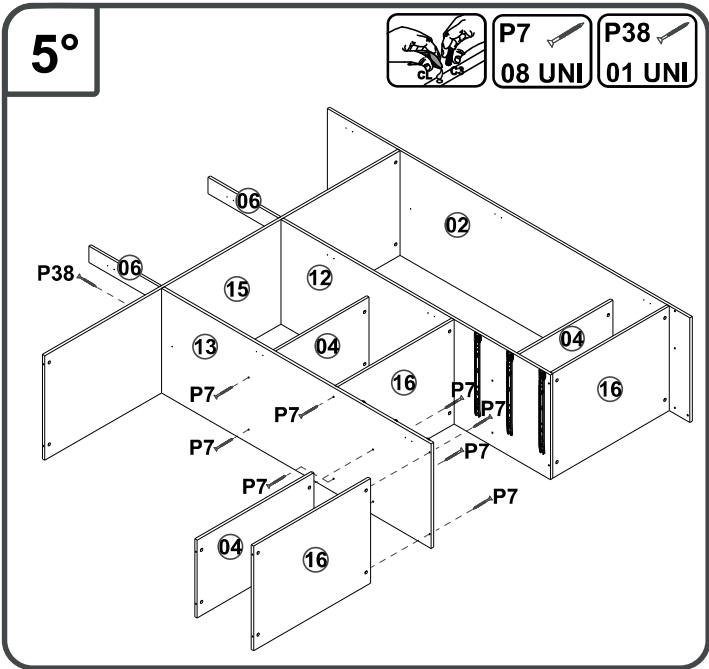
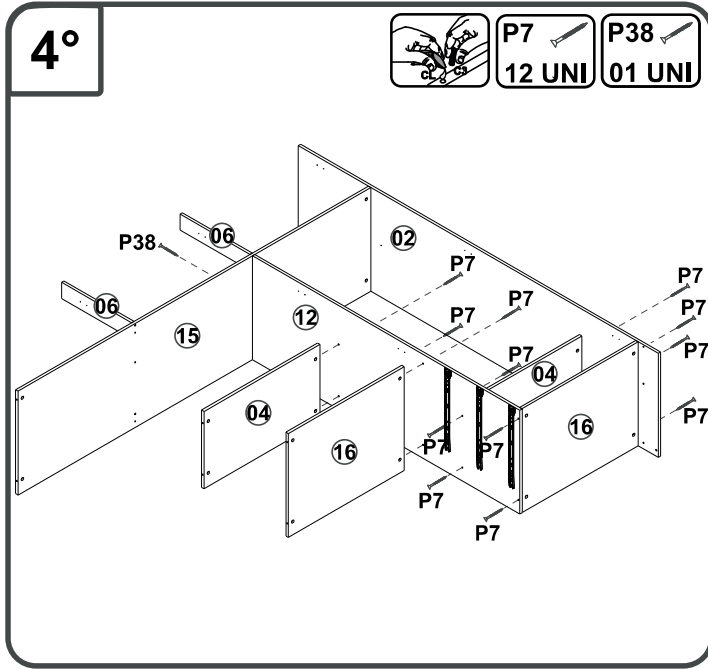
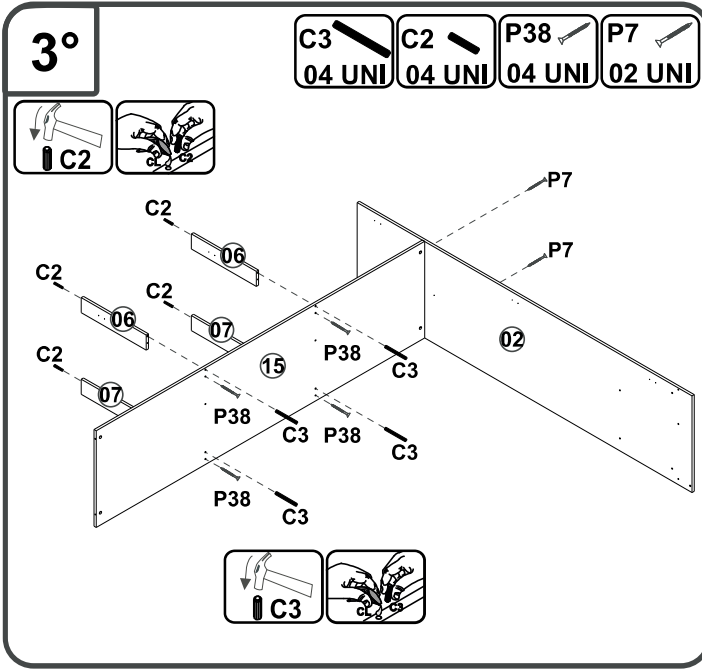
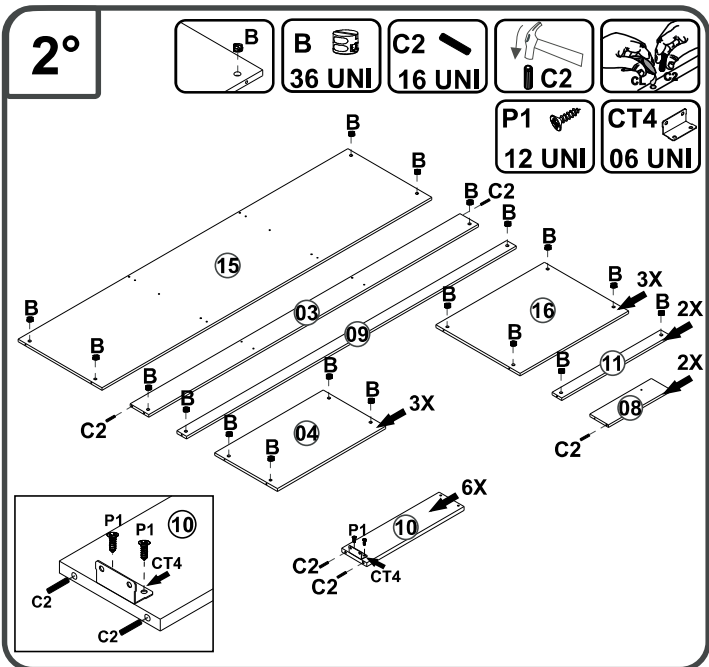
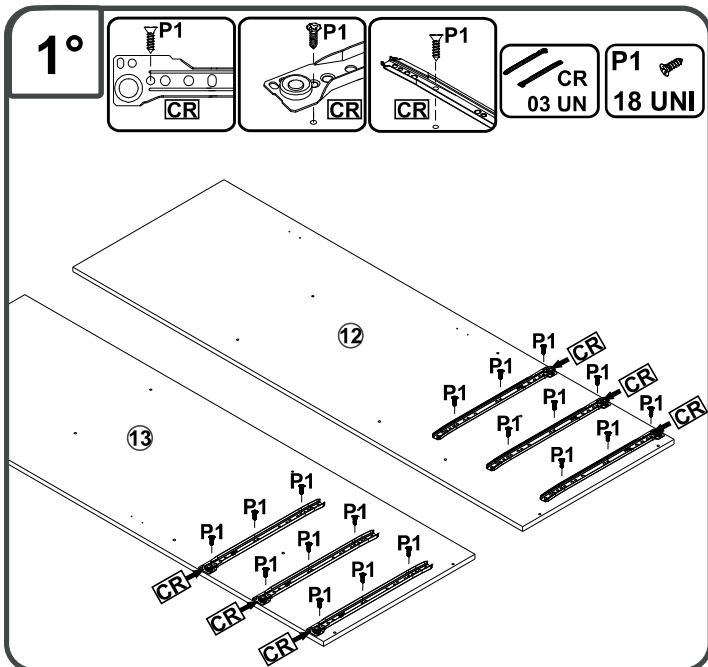
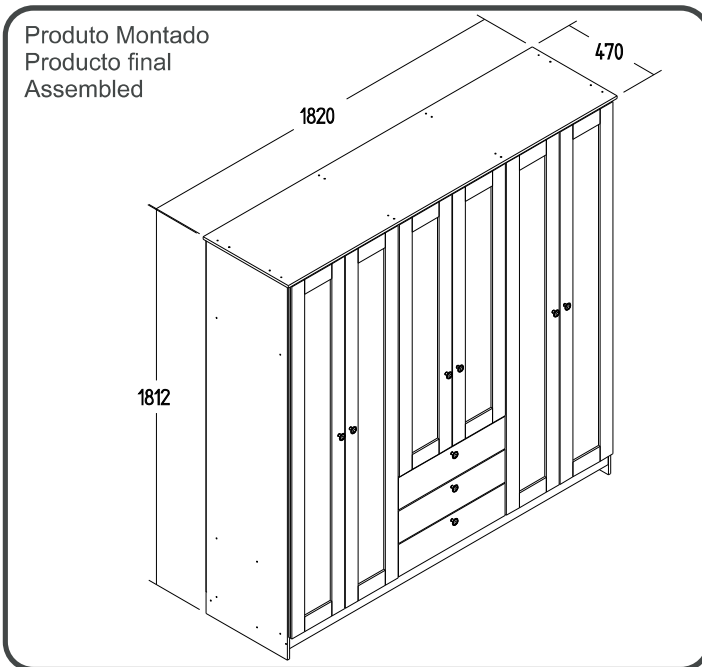

RP2630 ROUPEIRO

Manual de Montagem
 Assembly Instructions
 Instrucción de Montaje

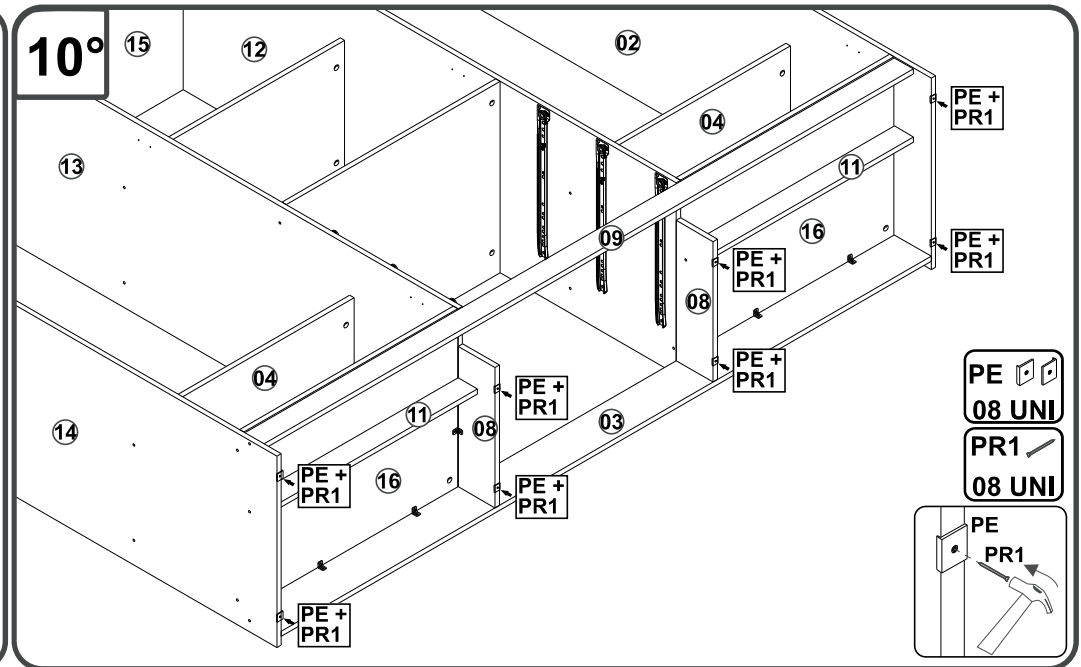
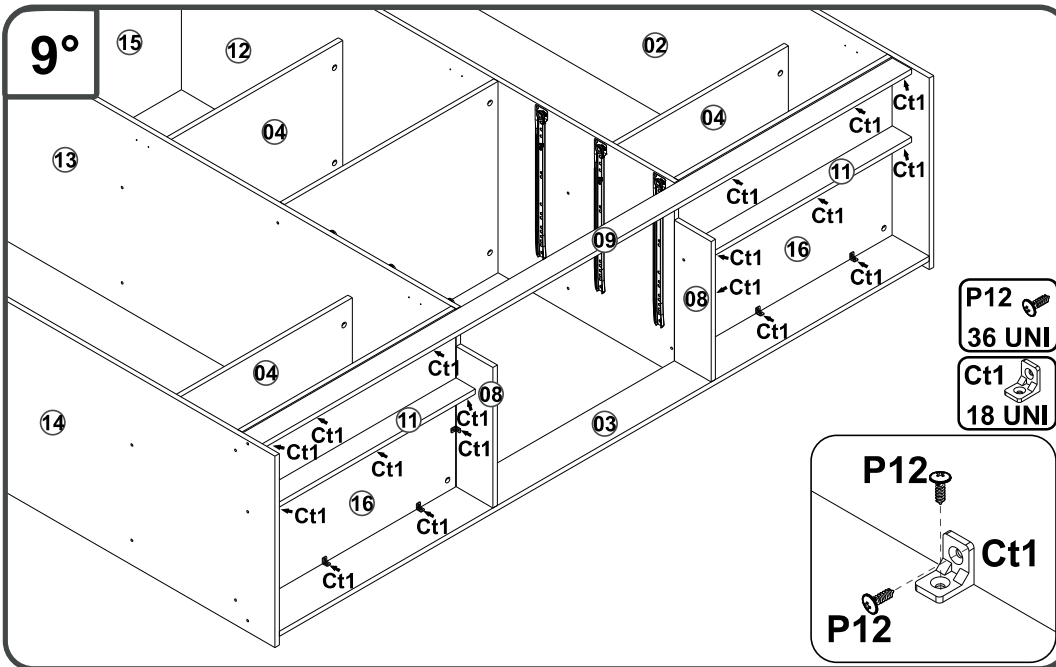
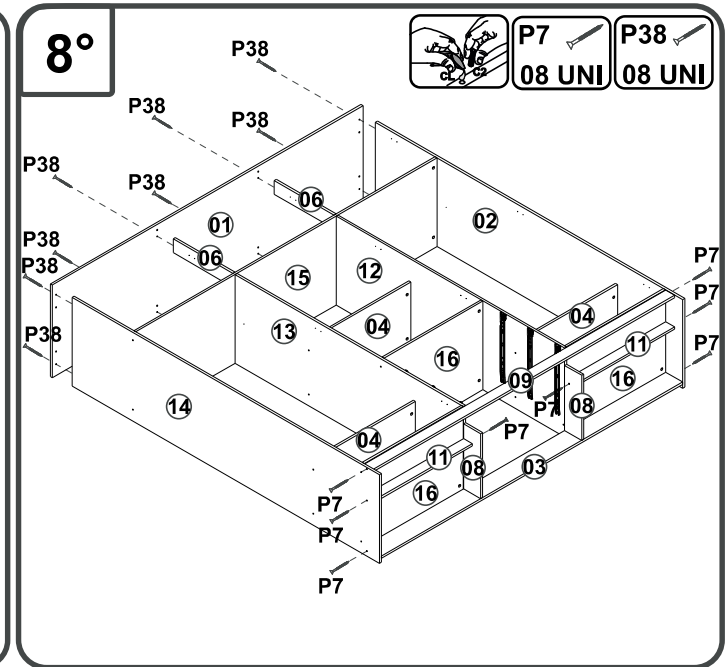
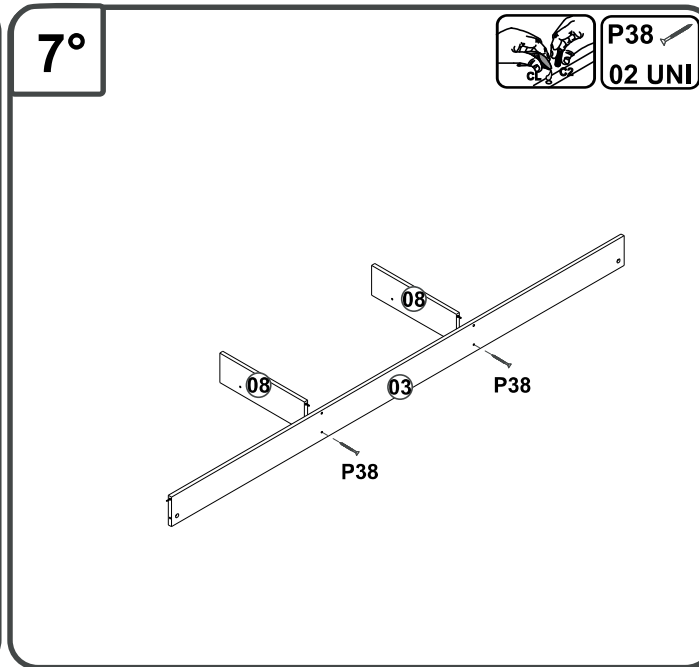
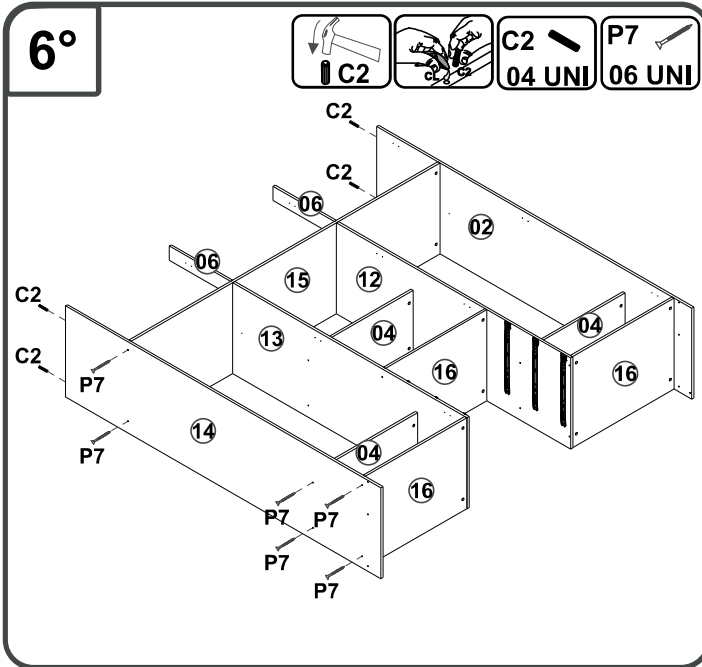

11°

- Pr1
- Pr1
132 UNI
- FX
28 UNI

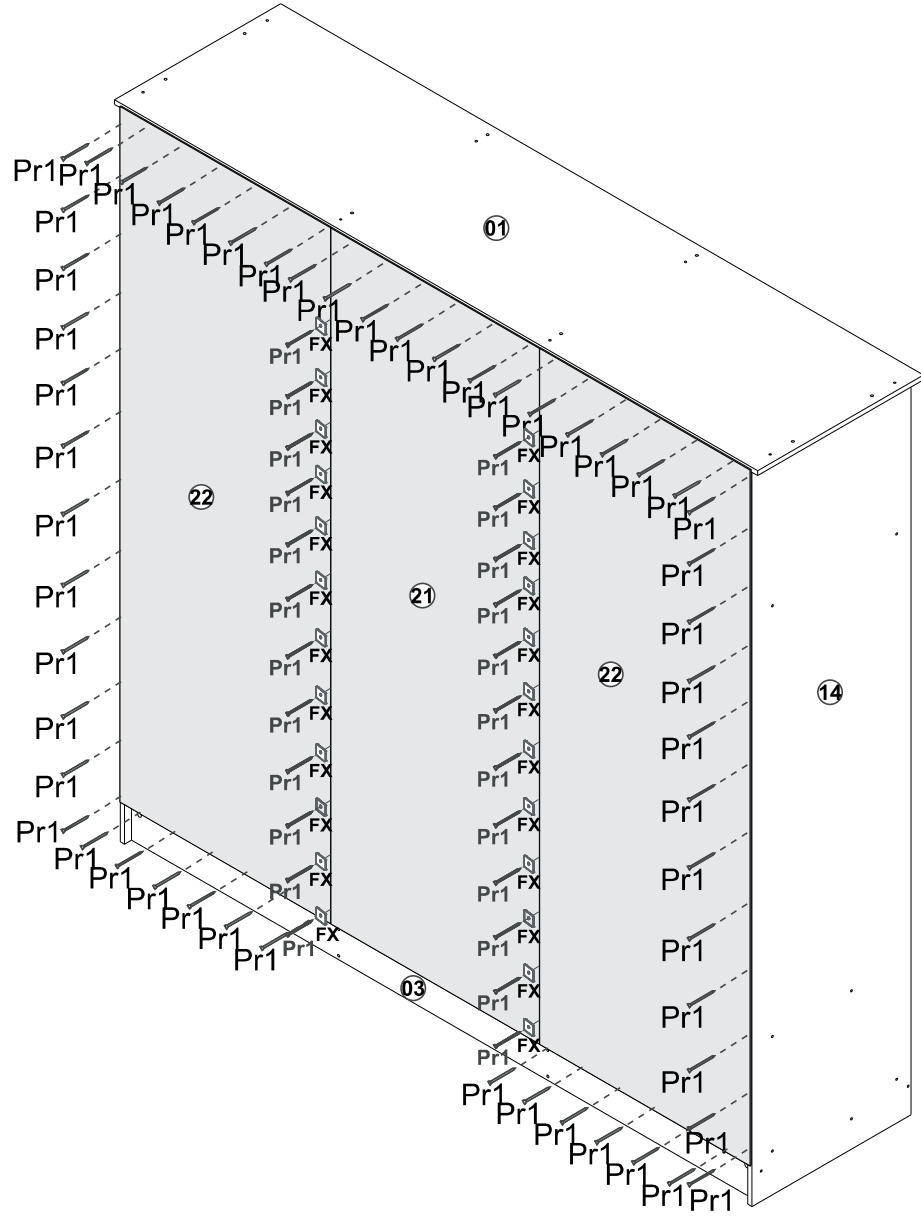

12°

3X

- PX
01 UNI
- P16
01 UNI
- P38
04 UNI
- PR1
10 UNI
- P1
10 UNI

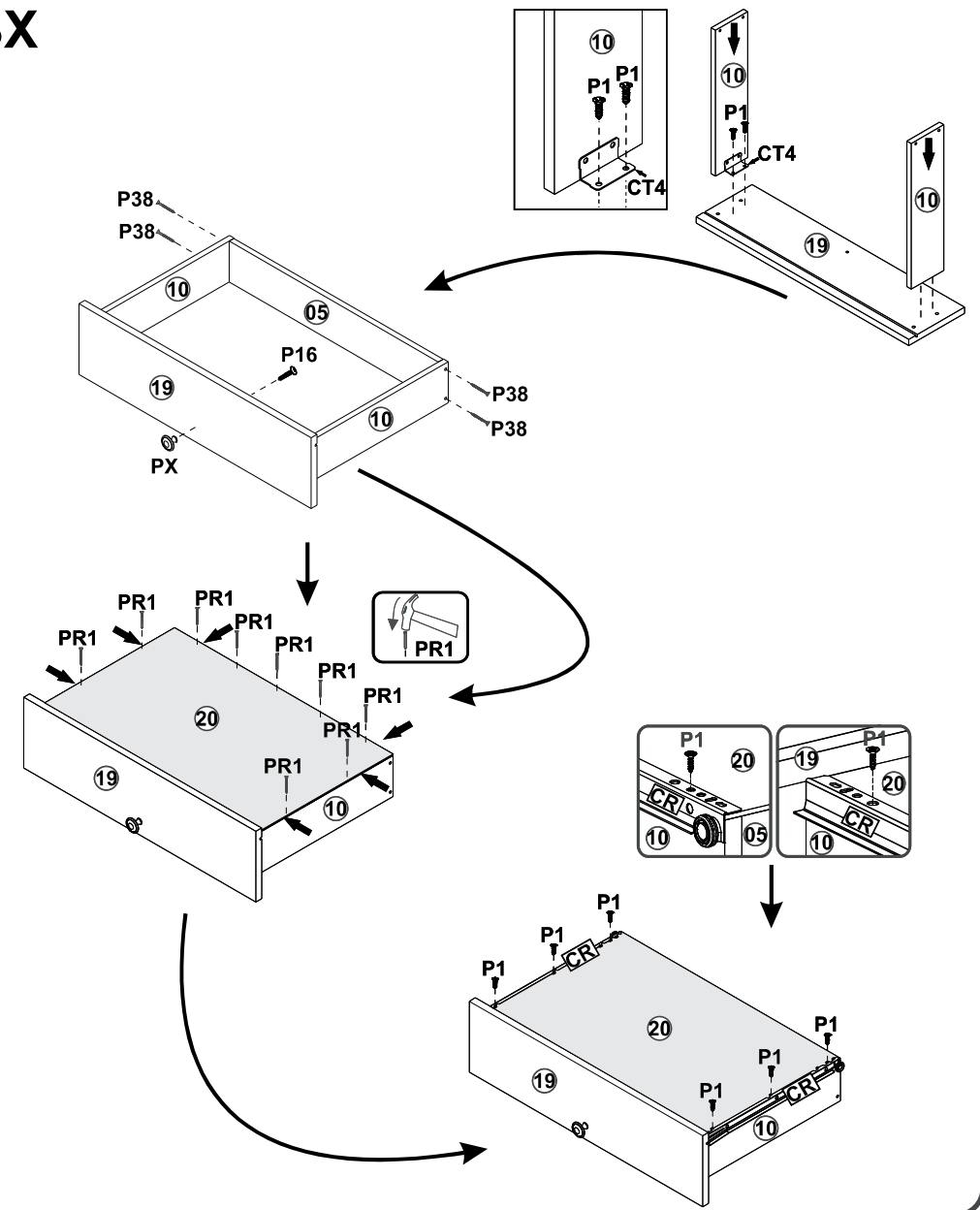

RP2630 ROUPEIRO

Manual de Montagem
 Assembly Instructions
 Instrucción de Montaje

decibal[®] móveis

13°



PESO SUPORTADO DISTRIBUÍDO.
 PESO SOPORTADO DISTRIBUIDO.
 DISTRIBUTED SUPPORTED WEIGHT.

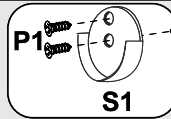
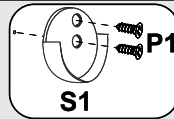

S1
 04 UNI

P1
 08 UNI

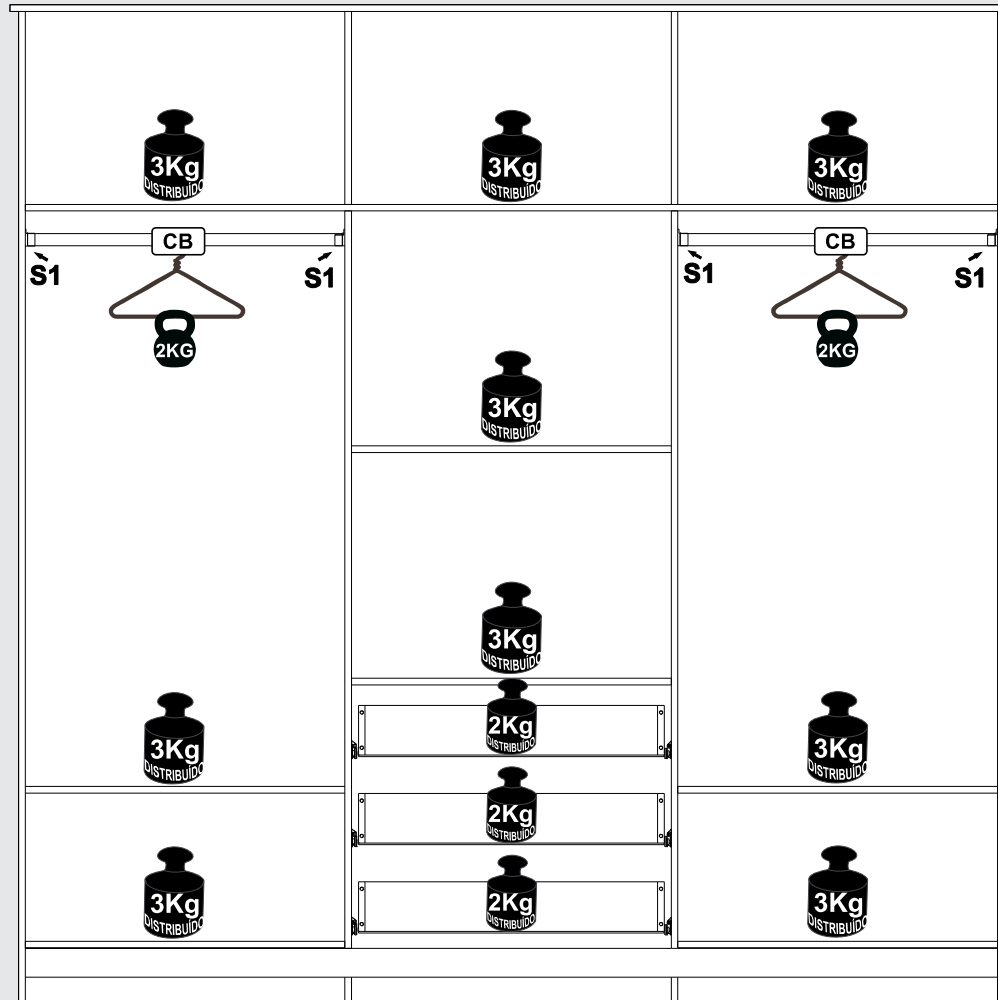

14°

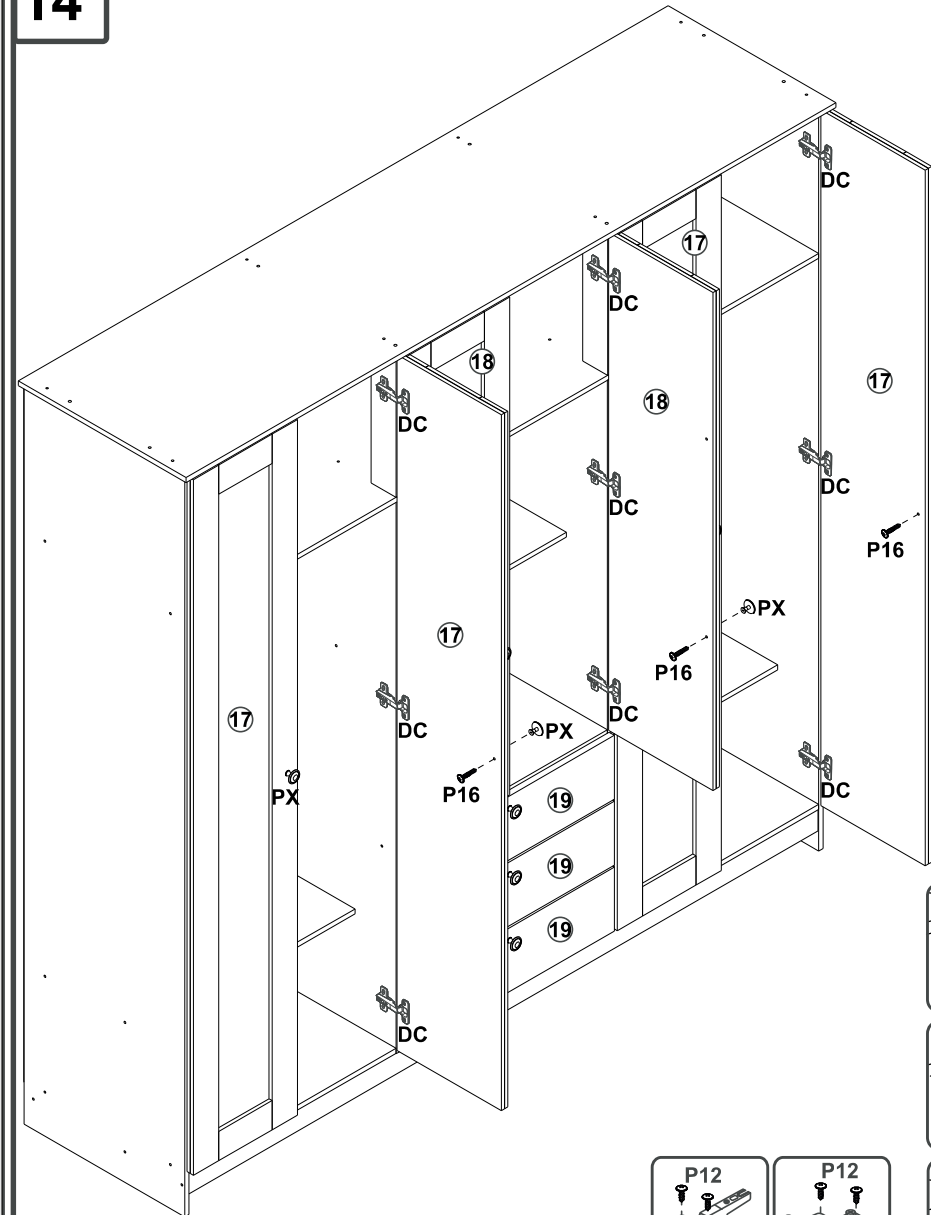

PX
 06 UNI

P16
 06 UNI

P12
 72 UNI

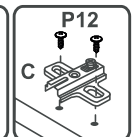
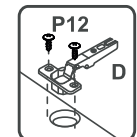
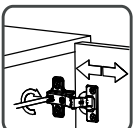
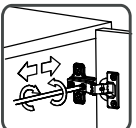
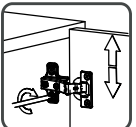

RP2630 ROUPEIRO

Manual de Montagem
Assembly Instructions
Instrucción de Montaje



decibal[®]
móveis

Instrucción de Montaje

Relação de Peças/ Relación de Piezas/Parts List

Nº	CÓDIGO/CODE	DESCRIÇÃO/DESCRIPCIÓN/DESCRIPTION	QTD/CANT	VOL.
1	0570494	TAMPO/TAPA/TOP	1820X470X12MM	1 1
2	0570486	LATERAL DIR/LATERAL/SIDE	1800X450X12MM	1 1
3	0570493	RODAPE TRS/ZÓCALO/BASEBOARD	1764X100X12MM	1 1
4	0570892	PRATELEIRA/ESTANTE/SHELF	580X335X12MM	3 1/2
5	0570481	BATENTE/REVÉS CAJÓN/DRAWER BACK	531x90X12MM	3 1
6	0570896	PILASTRA SUP/PILASTRE/PILASTER	350X70X12MM	2 1
7	0570897	PILASTRA SUP T/PILASTRE/PILASTER	350X70X12MM	2 1
8	0570492	RODAPE INT/ZÓCALO/BASEBOARD	330X100X12 MM	2 1
9	0570491	RODAPE FRT/ZÓCALO/BASEBOARD	1764X52X12MM	1 1
10	0570524	LAT GAV/LATERAL CAJÓN/DRAWER SIDE	531X90X12MM	6 1
11	0570898	TRAVESSA RP/TRAVIESSA/TRVERSE	350X90X12 MM	2 1
12	0570890	DIVISORIA DIR/DIVISOR DERECHO/RIGTH DIVIDER	1338X450X12MM	1 1
13	0570531	DIVISORIA ESQ/DIVISOR ESQUIERDO/LEFT DIVIDER	1338X450X12MM	1 1
14	0570487	LATERAL ESQ/LATERAL/SIDE	1800X450X12MM	1 1
15	0570893	BASE MALEIRO/BASE MALETA/SUITCASO BASE	1764X450X12MM	1 1
16	0570889	BASE	580X450X12MM	3 2
17	0571170	PORTA MAIOR/PUERTA/DOOR	1688X292X18MM	4 2
18	0571163	PORTA MENOR/PUERTA/DOOR	1208X292X18MM	2 2
19	0570484	FRENTE GAV/FRENTE CAJÓN/	589X155X15MM	3 2
20	0570504	FUNDO GAV/FONDO CAJÓN/DRAWER BOTTOM	554X355X2,8MM	3 2
21	0570501	COSTA CENTRAL/REVÉS/BACK	1706X590X2,8MM	1 2
22	0570500	COSTA/REVÉS/BACK	1706X596X2,8MM	2 2

Escala (N/A)

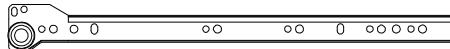
LEGENDA	DESCRIÇÃO/DESCRIPCIÓN/DESCRIPTION	CÓDIGO	QUANT.
CB	 CABIDEIRO/ROLIZO PERCHA/ROD FOR HANGERS 570 MM	13490	02
PX	 PUXADOR/PEGADOR/HANDLE	13039	09
CR	 CORREDICA/CORREDERA/METTALIC SLIDE 350MM	01225	03

www.decibal.com.br

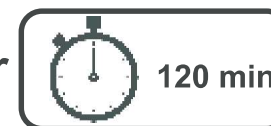

120 min.

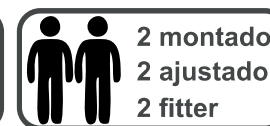

2 montador
2 ajustador
2 fitter

Ferramentas necessárias
Necessary tools
Herramientas necesarias

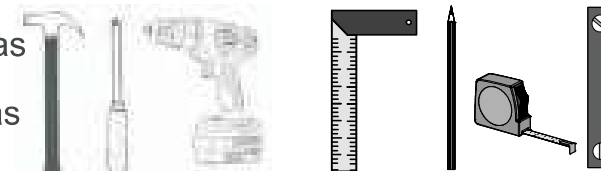

ATENÇÃO!!!! montadores e consumidores

* Para limpar o móveis utilize somente um pano úmido (umedecido em água pura ou água com sabão neutro). Depois, passe um pano seco. Evite a umidade excessiva.

* Evite usar álcool, água sanitária, detergente e outros produtos químicos, mesmo diluídos em água.

* Não utilize produtos abrasivos de nenhuma espécie

ATENCIÓN!!!! montadores e consumidores

* Para limpiar el mueble utilice solamente un paño húmedo (humedecido con agua limpia o con un jabón suave). Acontinución, utilice un paño seco. Evite el exceso de humedad.

* Evite uso de alcohol, hipocloridro solución basada, detergente y otros productos químicos, mismo diluídos en agua. No utilice productos abrasivos de ningún tipo.

ATTENTION!!!! assemblers and consumers

*To clean the furniture, use only a damp cloth (humidify it only in pure water ou water and neutral soap). After, use a dry cloth.Avoid excessive humidity.

*Avoid using alcohol, bleach, detergent and other chemical products, even diluted in water. Do not use any kind of abrasive cleaning agents to clean the furniture.

The use of such products may jeopardize the ?nal characteristics of the furniture.

ATENÇÃO!!!! montadores e consumidores

* Ajustar o torque da parafusadeira para não danificar as peças escareando o parafuso *

ATENCIÓN!!!! montadores e consumidores

* Ajuste el torque del destornillador para no dañar las piezas avallanando el tornillo *

ATTENTION!!!! assemblers and consumers









* Adjust the torque of the screwdriver so as not to damage the parts by countersinking the screw *

RP2630 ROUPEIRO









Manual de Montagem
Assembly Instructions
Instrucción de Montaje

decibal[®]
móveis

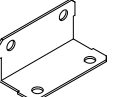
Escala (1:1)

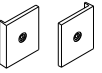
LEGENDA	DESCRIÇÃO/DESCRIPCIÓN/DESCRIPTION	CÓDIGO	QUANT.
P1	 PARAFUSO/TORNILLO/SCREW 3X12	01328	68
P7	 PARAFUSO/TORDILHO/SCREW 4X45	01318	36
P12	 PARAFUSO/TORNILLO/SCREW 3,5X13	09927	108
P16	 PARAFUSO/TORNILLO/SCREW 3,5X30	13502	09
P38	 PARAFUSO/TORNILLO/SCREW 3,5X40	12425	28
PR1	 PREGO/CLAVO/NAIL 10X10	01330	170
B	BUCJA/BUJE/BUCHING 	02734	36
C2	 CAVILHA/TARUGO/DOWEL 6X30 MM	01211	26
C3	 CAVILHA/TARUGO/DOWEL 6X50 MM	01212	04

Escala (N/A)

LEGENDA	DESCRIÇÃO/DESCRIPCIÓN/DESCRIPTION	CÓDIGO	QUANT.
CL	 COLA/PEGAMENTO/GLUE	01213	01
ET	 ETIQUETA LOGO DECIBAL/LABEL DECIBAL	01312	01
Ct4	 CANTONEIRA/PIEZA L/SHEET	03110	06
Ct1	 CANTONEIRA/PIEZA L/SHEET	03077	18
PE	PE/PATA/FOOT 15X15MM 	01367	08
S1	 SUPORTE CABIDEIRO/SOPORTE PERCHERO SUPPORT TO HANGER SUPPORT	02033	04
FX	 FIXADOR COSTA/FIJADOR FONDO/FIXER COAST	01331	28
AD	 ADESIVO/ADHESIVO/ADHESIVE	15mm	18
DC	 DOBRADIÇA/BISAGRA/HINGE D=26mm C=5mm	12656	18

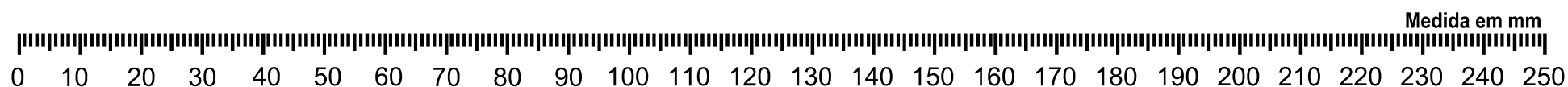

Agora que você já comprou o seu móvel, ele merece ser montado do jeito certo.

Erros de montagem causam mais de **60%** dos danos em móveis.

Por que contratar?

Tranquilidade do **início ao fim** da montagem



PROFISSIONAIS QUALIFICADOS

Especialistas certificados na **MadeiraMadeira Serviços**.



FERRAMENTAS PROFISSIONAIS

que **protegem** seus móveis.



AGENDAMENTO EM 24 HORAS

escolha a data e o turno **ideais para** você.



GARANTIA DE 3 MESES

de cobertura **completa**.

Mais de 1 MILHÃO DE MONTAGENS
★ com avaliação **4.7** ★

Mariana S., São Paulo

"Chegaram no horário e montaram tudo rapidamente. Serviço incrível!"



Carlos R., Belo Horizonte

"Tentei montar sozinho e foi um desastre. Com a **MadeiraMadeira Serviços** ficou perfeito."



Ana P., Rio de Janeiro

"Agendamento ágil e **montagem pontual e perfeita**. Recomendo demais!"



Agende agora pelo QR Code

Madeira**Madeira** Serviços · Atendimento em todo o Brasil



Escaneie o QRCode