

Acessórios

-  Paraf. Ø3,5x40 mm
Montagem estrutura 24
-  Par. Ø3,5x25 mm
puxador e união 12
-  Par. Ø3,5x13 mm
P/cantoneiras,
Dobradiça e calço 34
-  Cavilha Ø6x30 mm
Montagem estrutura 2
-  Ø26mm
Dobradiça CURVA 06
-  Calço 5 (Baixo)
-  Puxador Antar
274mm 2
-  Perfil "H" 1440mm
União dos fundos 1
-  Cantoneira
P/ Moldura Superior 5
-  Prego 10 x 10
Fundos 80
-  KIT
Suporte aéreo 2
c/ capa.
12 paraf. Ø4 x 13mm
4 paraf. Ø6 x 60mm
4 bucha Ø8mm
-  Tapa Furo 24

Montagem da Estrutura

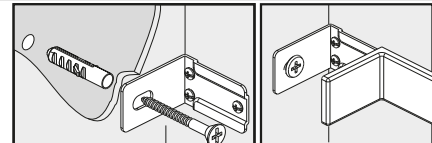
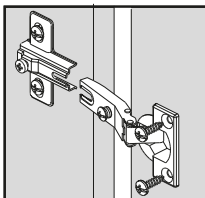

Fixe a cantoneira na lateral.
Posicione o módulo e através
das cantoneiras, fixe na parede
com bucha e parafuso.

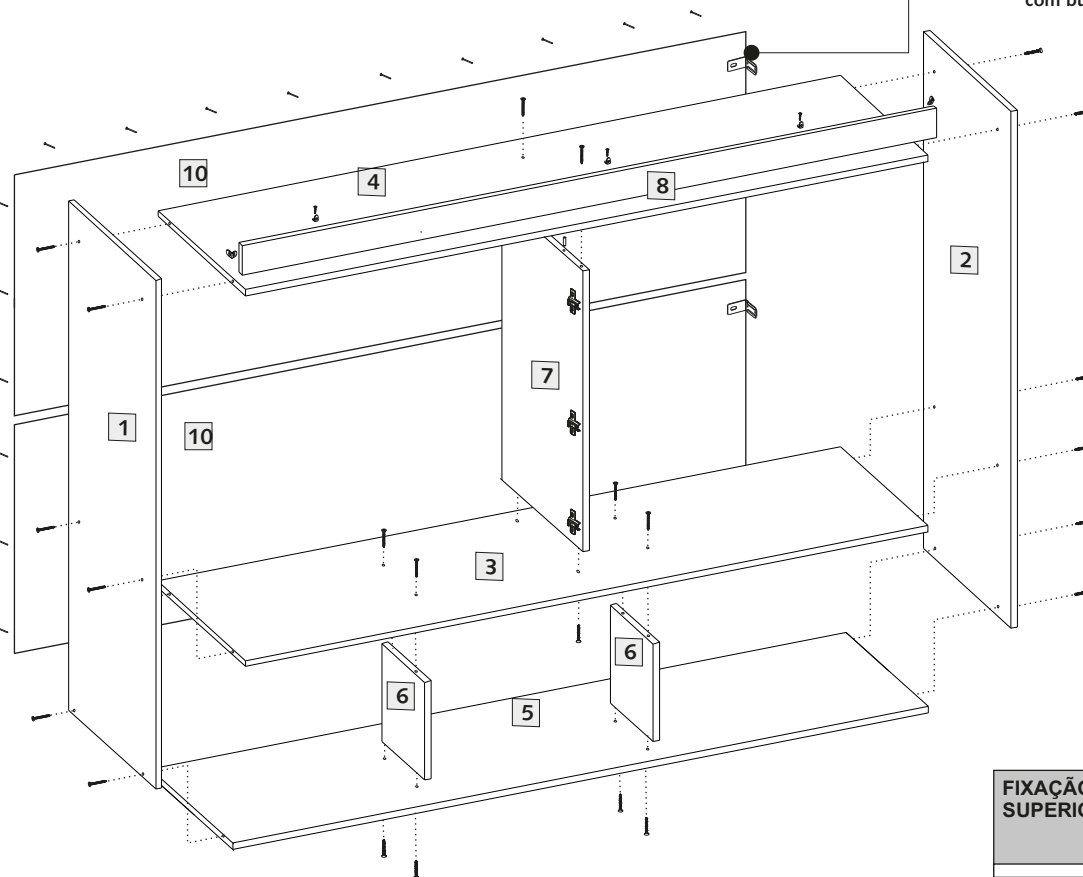

Armário PONTE 1,47m MASTER

Larg.: 1470mm Alt.: 820mm Prof.: 415mm

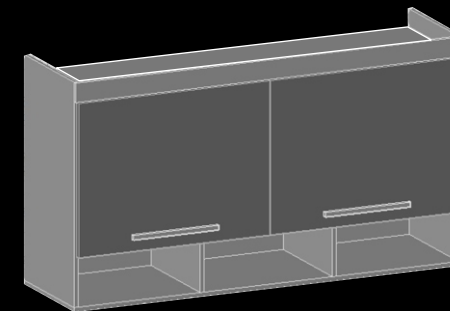

Item	Componente	QT.	ALT. X LARG.	Assist.Téc.
01	Lateral Esquerda	01	820 x 400	
02	Lateral Direita	01	820 x 400	
03	Base Maleiro	01	400 x 1440	
04	Chapéu	01	400 x 1440	
05	Base Nicho	01	400 x 1440	
06	Divisão Nicho	04	175 x 400	
07	Divisão Principal	01	535 x 400	
08	Moldura Superior	01	70 x 1470	
09	Portas	02	725 x 550	
10	Fundos	02	1465 x 375	

FIXAÇÃO MOLDURA SUPERIOR



VISTA LATERAL







ATENÇÃO!

Fixar a moldura superior
de acordo com o desenho.

Conservação e Limpeza

Para a limpeza basta utilizar pano macio ligeiramente úmido.
Não use álcool ou abrasivos que poderão danificar a camada de verniz.

Acessórios

-  Paraf. Ø3,5x40 mm
Montagem estrutura 24
-  Par. Ø3,5x25 mm
puxador e união 12
-  Par. Ø3,5x13 mm
P/cantoneiras,
Dobradiça e calço 42
-  Cavilha Ø6x30 mm
Montagem estrutura 2
-  Ø26mm
Dobradiça CURVA 08
-  Calço 5 (Baixo)
-  Puxador Antar
274mm 2
-  Perfil "H" 1640mm
União dos fundos 1
-  Cantoneira
P/ Moldura Superior 5
-  Pregão 10 x 10
Fundos 80
-  KIT
Suporte aéreo 2
c/ capa.
12 paraf. Ø4 x 13mm
4 paraf. Ø6 x 60mm
4 bucha Ø8mm
-  Tapa Furo 24

Montagem da Estrutura

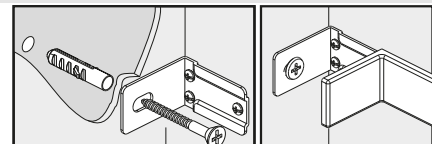
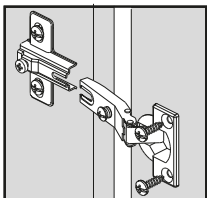

Fixe a cantoneira na lateral.
Posicione o módulo e através
das cantoneiras, fixe na parede
com bucha e parafuso.

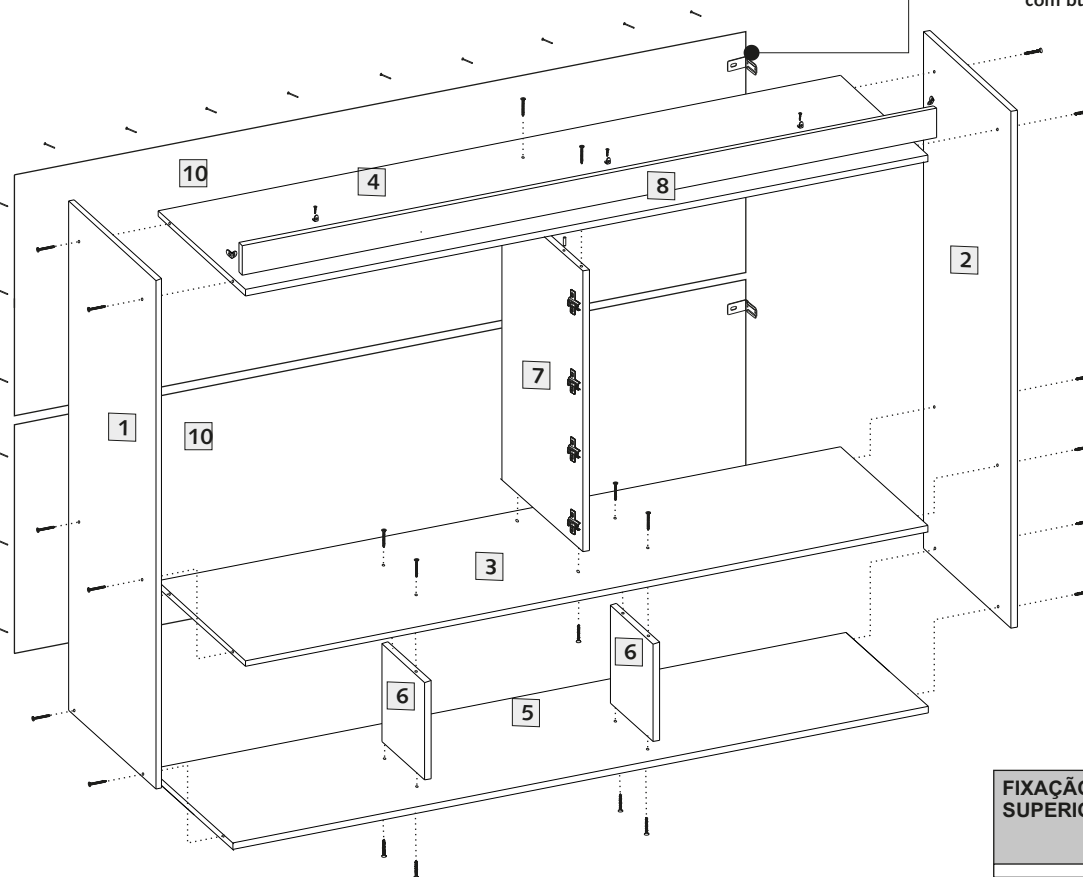

Armário PONTE 1,67m MASTER

Larg.: 1670mm Alt.: 820mm Prof.: 415mm

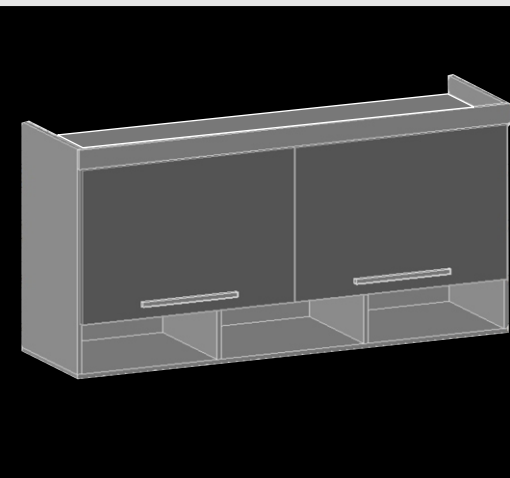

Item	Componente	QT.	ALT. X LARG.	Assist.Téc.
01	Lateral Esquerda	01	820 x 400	
02	Lateral Direita	01	820 x 400	
03	Base Maleiro	01	400 x 1640	
04	Chapéu	01	400 x 1640	
05	Base Nicho	01	400 x 1640	
06	Divisão Nicho	04	175 x 400	
07	Divisão Principal	01	535 x 400	
08	Moldura Superior	01	70 x 1670	
09	Portas	04	825 x 550	
10	Fundos	02	1665 x 375	

FIXAÇÃO MOLDURA SUPERIOR



VISTA LATERAL

ATENÇÃO!

Fixar a moldura superior
de acordo com o desenho.

Conservação e Limpeza

Para a limpeza basta utilizar pano macio ligeiramente úmido.
Não use álcool ou abrasivos que poderão danificar a camada de verniz.