

PRODUTO CONCLUÍDO  
PRODUCTO TERMINADO  
FINISHED PRODUCT

ITM/D350-  
REV. 000



**HENN**

Ind. e Com. de Móveis Henn  
Mondai - SC - Brasil

+55 49 3674.3500

@moveishenn  
www.henn.com.br

ITM/D350-  
**INSTRUÇÕES DE  
MONTAGEM**

INSTRUCCIONES DE MONTAJE  
ASSEMBLY INSTRUCTIONS

**D350 ROUPEIRO DREAM 02 PORTAS DESLIZANTES |  
ARMARIO DREAM CON 02 PUERTAS CORREDERAS | DREAM WARDROBE WITH 02 SLIDING DOORS**

D350-228 Avelã/Off White



**AVISO**

Para limpeza de seu móvel, use uma flanela seca ou umedecida, e não utilize produtos químicos que possam danificar seu produto.

**SISTEMA DE MONTAGEM**

O sistema de montagem dos produtos, funciona de acordo com a ordem crescente dos números indicados no desenho. Ex: 01, 02, 03, 04... até a conclusão da montagem.

**ASSISTÊNCIA TÉCNICA**

Para solicitação de Assistência Técnica você consumidor deverá entrar em contato com o Lojista o qual você realizou a compra deste produto e solicitar a assistência técnica das peças avariadas. A garantia abrange todas as peças, partes e componentes que eventualmente venham apresentar defeito de fabricação no prazo de 03 (três) meses, contando a partir da entrega do produto ao consumidor, mediante nota fiscal de compra. Se houver qualquer alteração na estrutura do produto ou ocorrer defeito por negligência do montador/consumidor em relação a instrução de montagem e manuseio, não será fornecido assistência técnica gratuita.

**ADVERTENCIA**

Para limpieza de su móbil, use una flanela seca o húmeda, y no utilice productos químicos que puedan dañar su producto.

**SISTEMA DE MONTAJE**

El sistema de montaje de los productos funciona de acuerdo con el orden creciente de los números indicados en el dibujo. Ej.: 01, 02, 03, 04... hasta la conclusión del montaje.

**ASISTENCIA TÉCNICA**

Para solicitar Asistencia Técnica, el consumidor debe comunicarse con el Comercio que usted realizó la compra de este producto y solicita asistencia técnica para las partes dañadas. La garantía cubre todas las partes, piezas y componentes que eventualmente puedan presentar defecto de fabricación en el plazo de 03 (tres) meses, contados a partir de la entrega del producto al consumidor, mediante factura de compra. Si se produce algún cambio en la estructura del producto o se produce un defecto por negligencia del montador/consumidor en relación con las instrucciones de montaje y manipulación, no se prestará asistencia técnica gratuita.

**NOTICE**

To clean your furniture, use a dry or wet cloth, and do not use chemicals that may damage your product.











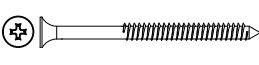



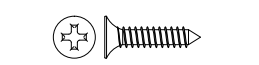
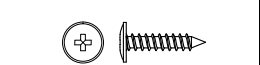
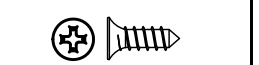
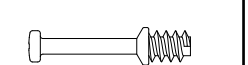

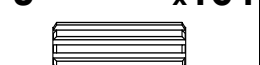



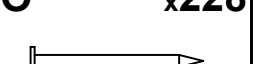
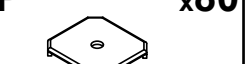

**ASSEMBLY SYSTEM**

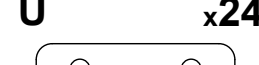
The products' assembly system works according to the increasing order of the indicated numbers. For example: 01, 02, 03, 04 ... to the end of the assembly.

**TECHNICAL ASSISTANCE**

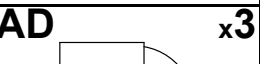
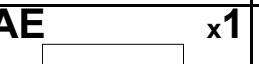

To request Technical Assistance, the consumer must contact the retailer from whom you purchased this product and request technical assistance for the damaged parts. The warranty covers all parts, parts and components that may eventually present a manufacturing defect within a period of 03 (three) months, counting from the delivery of the product to the consumer, by means of a purchase invoice. If there is any change in the structure of the product or defect occurs due to negligence of the assembler/consumer in relation to the assembly and handling instruction, free technical assistance will not be provided.

**ACESSÓRIOS | ACCESORIOS | ACCESSORIES**

<b>A</b> x8  Parafuso 4,5x60mm CHT.	<b>B</b> x29  Parafuso 4,0x45mm CHT.	<b>C</b> x38  Parafuso 4,0x35mm CHT	<b>D</b> x8  Parafuso 4,0x25mm CHT
<b>E</b> x24  Parafuso 3,0x16mm CHT.	<b>F</b> x8  Parafuso 3,5x14mm FLA.	<b>G</b> x341  Parafuso 3,5x12mm CHT.	<b>H</b> x15  Parafuso Minifix
<b>I</b> x15  Tambor Minifix	<b>J</b> x164  Cavilha Plástica 8x25mm	<b>K</b> x48  Cantoneira de Fixação Zamac	<b>L</b> x8  Porca Cilíndrica
<b>M</b> x4  Suporte Cabideiro Oblongo	<b>N</b> x8  Bucha Fixador de Espelho	<b>O</b> x228  Prego 10x10mm	<b>P</b> x80  Fixador de Fundo
<b>Q</b> x10  Pé "U" 50x40x100mm	<b>R</b> x12 Pares  Correção Telescópica 300x30mm	<b>S</b> x1  Kit Rodizio JP240R (2Portas)	<b>T</b> x2  Cabideiro Alumínio Oblongo Estriado 624
<b>U</b> x24  Suporte Metal	<b>V</b> x2  Perfil "U" 2196mm	<b>W</b> x2  Perfil Puxador MOV4027 2196mm	<b>X</b> x1  Trilho Inferior Alumínio 2572mm
<b>Y</b> x1  Trilho Superior PVC 2572 mm	<b>Z</b> x12  Cantoneira Suporte triangular	<b>AA</b> x64  Adesivo Tapa Parafuso 10mm	<b>AB</b> x8  Batente Injetad PVC
<b>AC</b> x3  Sachê de Cola 20g	<b>AD</b> x3  Giz de Correção	<b>AE</b> x1  Etiqueta Resinada Henn	

**MONTAGEM 14 | MONTAJE 14 | ASSEMBLY 14**

**ACESSÓRIOS REQUERIDOS**

AA		52	AE	<b>HENN</b>	01
AD		03			

PERFECT CORRECTION  
CORRECCIÓN PERFECTA

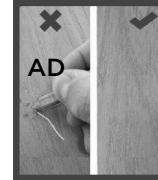

**Pesos máximos recomendados com carga distribuída**  
**Peso máximo recomendado con la carga distribuida**  
**Recommended maximum weight with distributed load.**

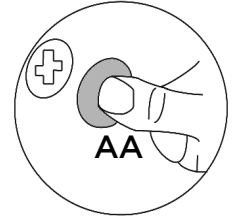
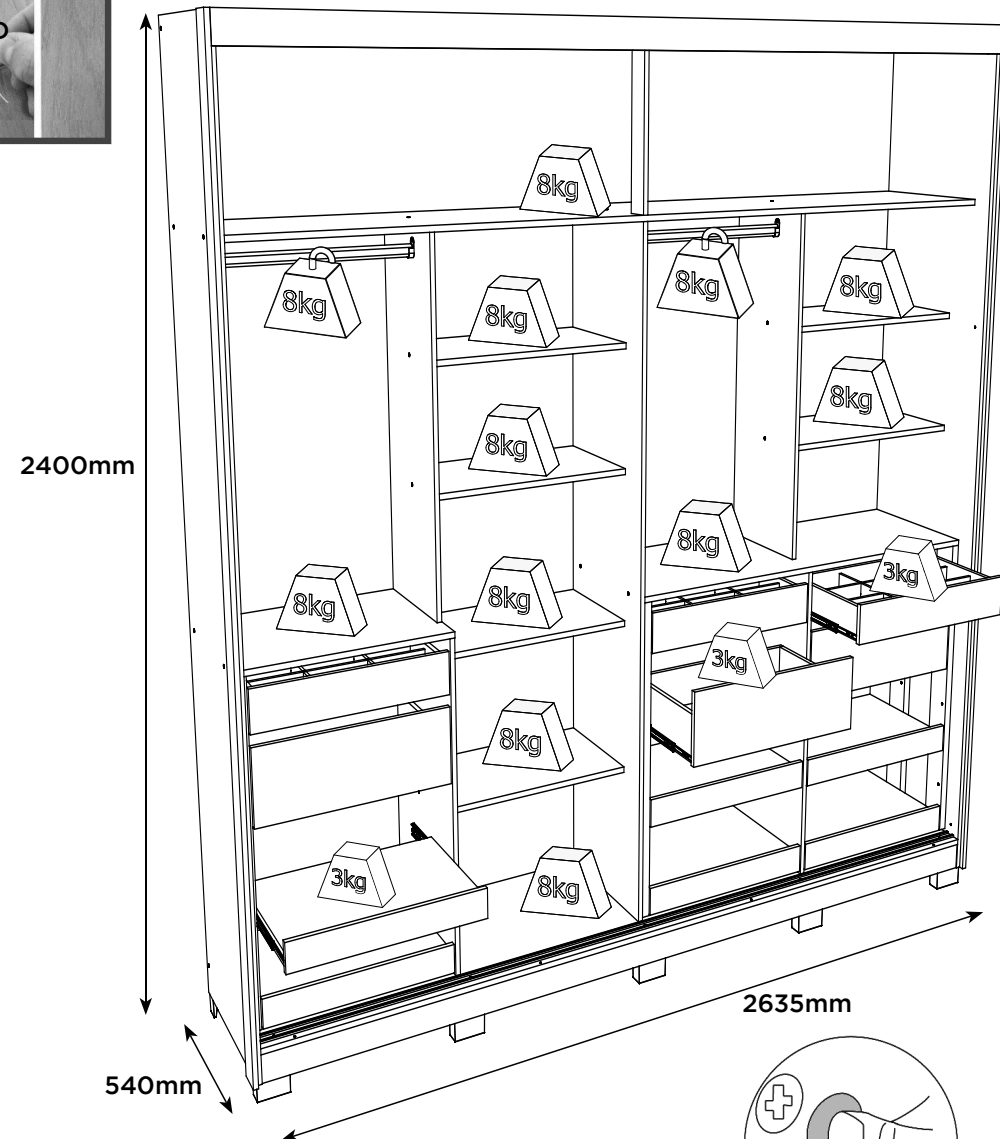

# MONTAGEM 12 | MONTAJE 12 | ASSEMBLY 12

ITM/D350-

## PEÇAS REQUERIDAS

34	PRATELEIRA MÓVEL	x6
35	TRAVESSA FRONTAL	x6
36	TRAVESSA	x12

## ACESSÓRIOS REQUERIDOS

G		84
I		12
K		24
R		12

## FERRAMENTAS NECESSÁRIAS

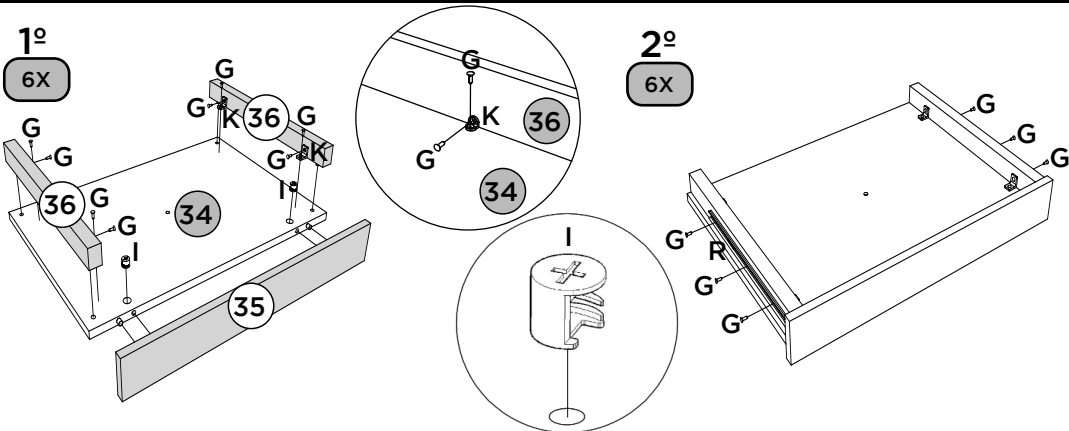
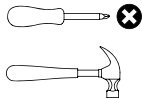

# MONTAGEM 13 | MONTAJE 13 | ASSEMBLY 13

## ACESSÓRIOS REQUERIDOS

AA		12	AB		08
----	--	----	----	--	----

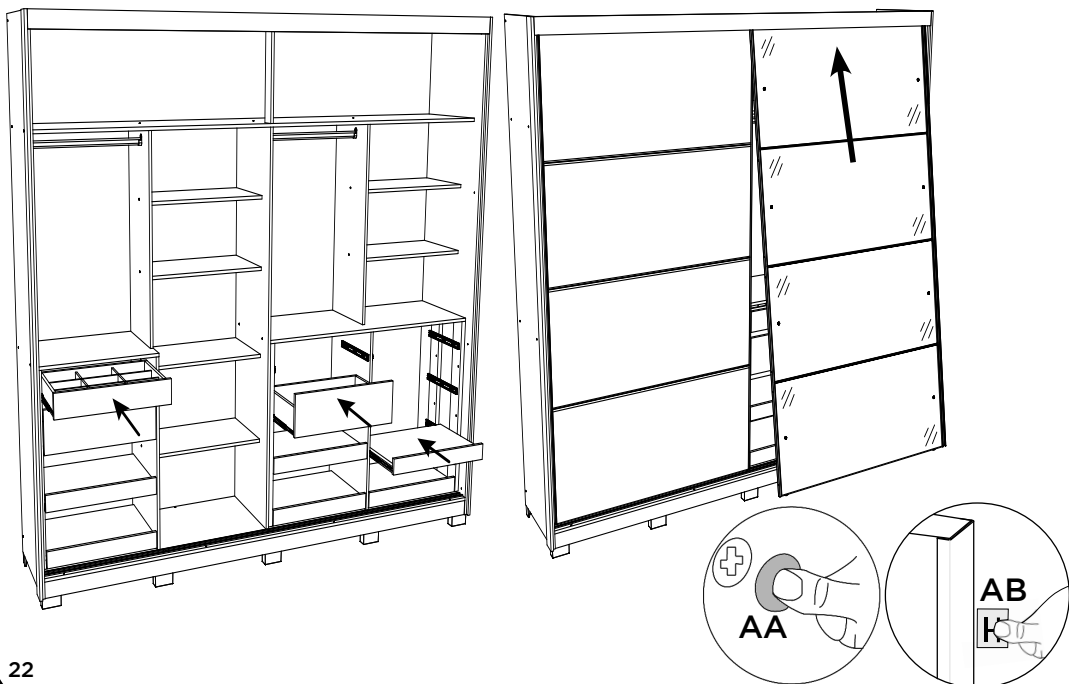

# PARAFUSOS EM ESCALA 1:1 | TORNILLOS A ESCALA 1:1 | 1:1 SCALE SCREWS

ITM/D350-

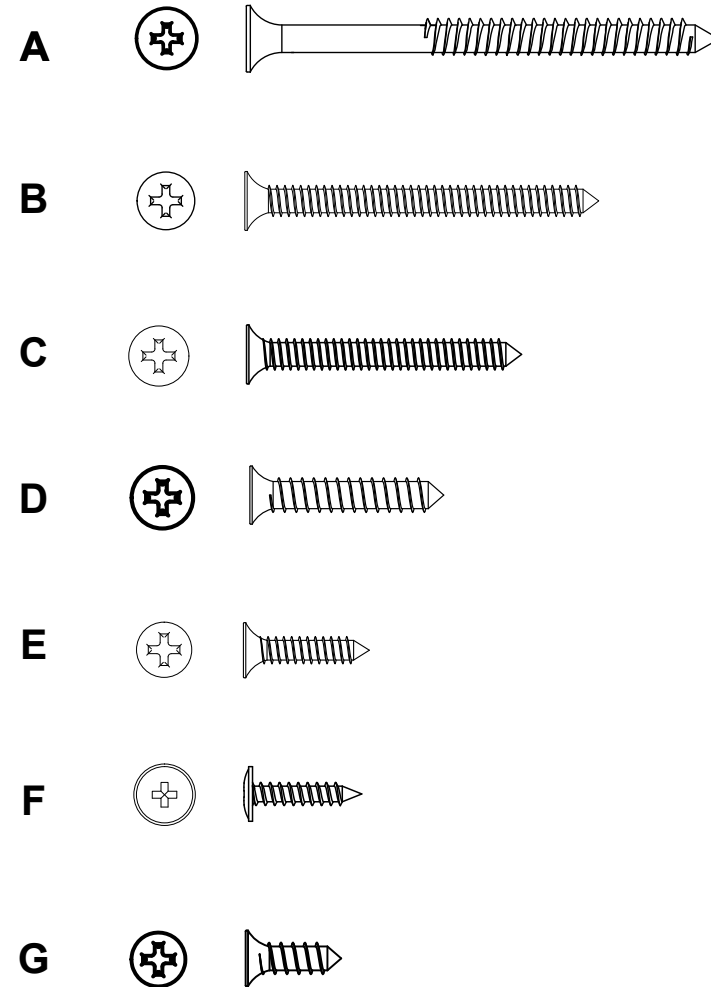

Item	Caixa Caja Box	Qtd Ctd Qty	Descrição Descripción Description	Dimensões (mm)   Dimensiones (mm)   Dimensions (mm)		
				Comprimento Largo Length	Largura Ancho Width	Espessura Grosor Thickness
1	2/7	1	RODAPÉ FRONTAL   ZÓCALO FRONTAL   FRONT SKIRTING	2573	73	15
2	3/7	3	TRAVESSA DO RODAPÉ   TRAVESAÑO DEL ZÓCALO   SKIRTING RAIL	484	73	15
3	2/7	1	RODAPÉ TRASEIRO   ZÓCALO TRASERO   REAR SKIRTING	2573	73	15
4	2/7	1	BASE   BASE   BASE	2573	520	15
5	1/7	1	TAMPO DAS GAVETAS ESQUERDA   TAPA DE LOS CAJONES IZQUIERDA   LEFT DRAWER TOP PANEL	648	450	15
6=12	3/7	1	DIVISÃO SUPERIOR   DIVISIÓN SUPERIOR   UPPER DIVIDER	925	355	15
7	1/7	1	DIVISÃO INFERIOR ESQUERDA   DIVISIÓN INFERIOR IZQUIERDA   LOWER LEFT DIVIDER	857	450	15
8	3/7	1	LATERAL ESQUERDA   LATERAL IZQUIERDA   LEFT SIDE PANEL	2350	520	15
9=17	4/7	4	PRATELEIRA   ESTANTE   SHELF	632	350	15
10	4/7	1	DIVISÃO   DIVISIÓN   DIVIDER	1797	450	15
11	4/7	1	TAMPO DAS GAVETAS DIREITA   TAPA DE LOS CAJONES DERECHA   RIGHT DRAWER TOP PANEL	1279	450	15
12=6	3/7	1	DIVISÃO SUPERIOR   DIVISIÓN SUPERIOR   UPPER DIVIDER	925	355	15
13	1/7	1	DIVISÃO INFERIOR DIREITA   DIVISIÓN INFERIOR DERECHA   LOWER RIGHT DIVIDER	857	450	15
14	2/7	1	CHÃO DO MALEIRO   FONDO DEL MALETERO   TRUNK BOTTOM	2573	450	15
15	3/7	1	RIPA DO MALEIRO   LISTÓN DEL MALETERO   TRUNK BATTEN	414	73	15
16	2/7	1	TAMPO   TAPA   TOP PANEL	2573	520	15
17=9	4/7	2	PRATELEIRA   ESTANTE   SHELF	632	350	15
18	3/7	1	LATERAL DIREITA   LATERAL DERECHA   RIGHT SIDE PANEL	2350	520	15
19	2/7	1	CHAPÉU   COPETE   TOP CAP	2602	73	15
20	2/7	1	FUNDO SUPERIOR   FONDO SUPERIOR   UPPER BACK PANEL	2593	437	15
21	4/7	4	FUNDO   FONDO   BACK PANEL	1818	648	15
22	1/7	6	RIPA LATERAL   LISTÓN LATERAL   SIDE BATTEN	848	80	15
23	3/7	2	MOLDURA LATERAL   MARCO LATERAL   SIDE FRAME	2350	73	15
24	5/7	3	FRENTE DE GAVETA   FRENTE DE CAJÓN   DRAWER FRONT	599	106	15
25	3/7	6	LADO DE GAVETA   LADO DE CAJÓN   DRAWER SIDE	350	90	15
26=32	3/7	3	FUNDO DE GAVETA RECORTADO   FONDO DE CAJÓN RECORTADO   CUT-OUT DRAWER BOTTOM	563	361	15
27	5/7	3	RIPA DE TRÁS   LISTÓN TRASERO   REAR BATTEN	582	122	15
28	5/7	6	DIVISÓRIA MENOR   DIVISOR MENOR   SMALLER DIVIDER	349	60	9
29	5/7	6	DIVISÓRIA MAIOR   DIVISOR MAYOR   LARGER DIVIDER	551	60	9
30	5/7	3	FRENTE DE GAVETA MAIOR   FRENTE DE CAJÓN MAYOR   LARGER DRAWER FRONT	599	192	15
31	3/7	6	LADO DE GAVETA MAIOR   LADO DE CAJÓN MAYOR   LARGER DRAWER SIDE	350	122	15
32=26	3/7	3	FUNDO DE GAVETA RECORTADO   FONDO DE CAJÓN RECORTADO   CUT-OUT DRAWER BOTTOM	563	361	15
33	3/7	3	RIPA DE TRÁS MAIOR   LISTÓN TRASERO MAYOR   LARGER REAR BATTEN	582	122	15
34	5/7	6	PRATELEIRA MÓVEL   ESTANTE MÓVIL   ADJUSTABLE SHELF	599	400	15
4 35	1/7	6	TRAVESSA FRONTAL   TRAVESAÑO FRONTAL   FRONT RAIL	599	75	15

PEÇAS REQUERIDAS

30	FRENTE DE GAVETA MAIOR	x3
31	LADO DE GAVETA MAIOR	x6
32=26	FUNDO DE GAVETA RECORTADO	x3
33	RIPA DE TRÁS MAIOR	x3

ACESSÓRIOS REQUERIDOS

C		06
E		06
G		30
K		06
R		06

FERRAMENTAS NECESSÁRIAS

Z		06
AC		

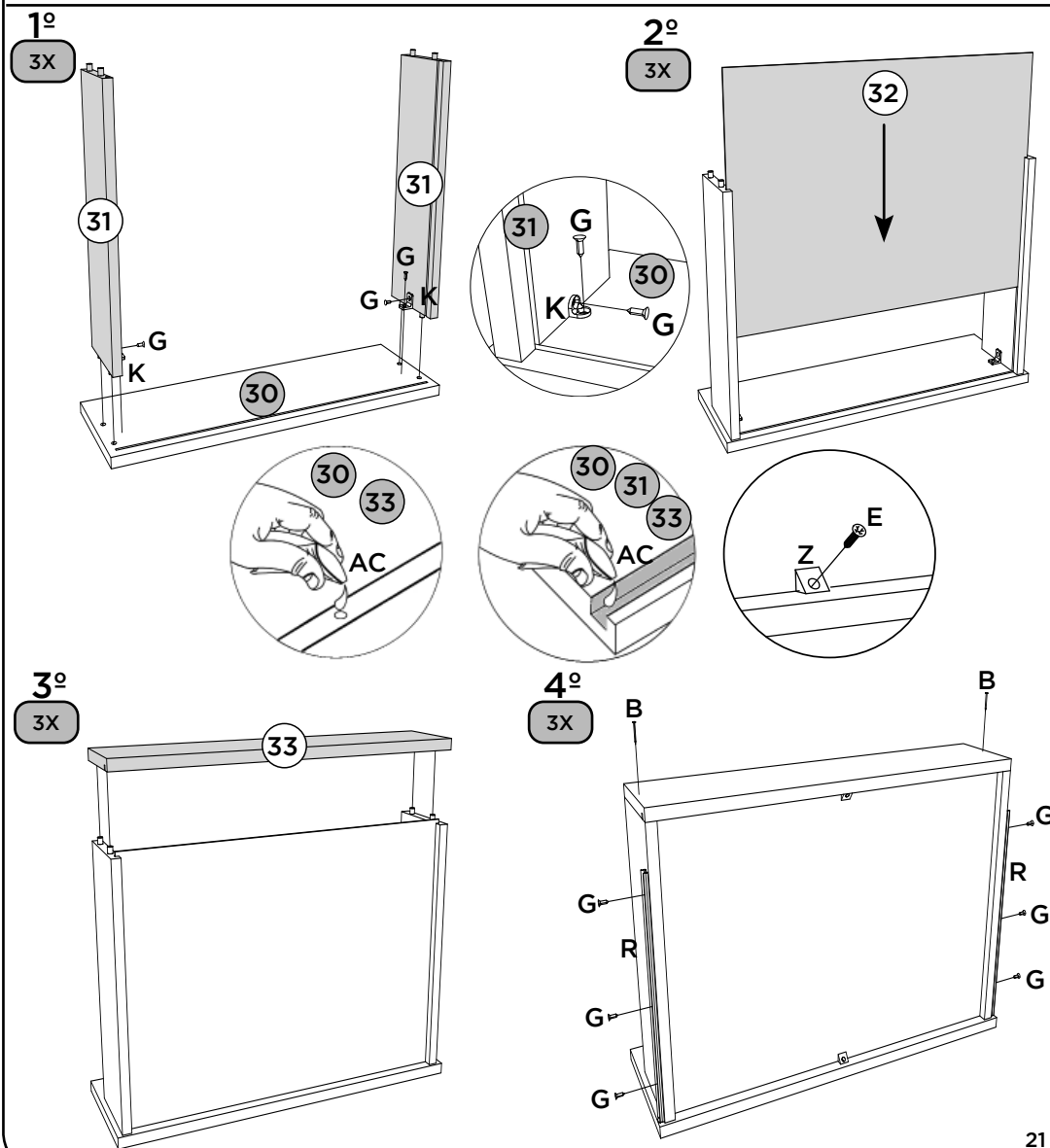

**PEÇAS REQUERIDAS**

24	FRENTE DE GAVETA	x3
25	LADO DE GAVETA	x6
26	FUNDO DE GAVETA RECORTADO	x3
27	RIPA DE TRÁS	x3
28	DIVISÃO MENOR	x6
29	DIVISÃO MAIOR	x6

**ACESSÓRIOS REQUERIDOS**

C		06
E		06
G		30
K		06
R		06

**FERRAMENTAS NECESSÁRIAS**

Z		06
AC		

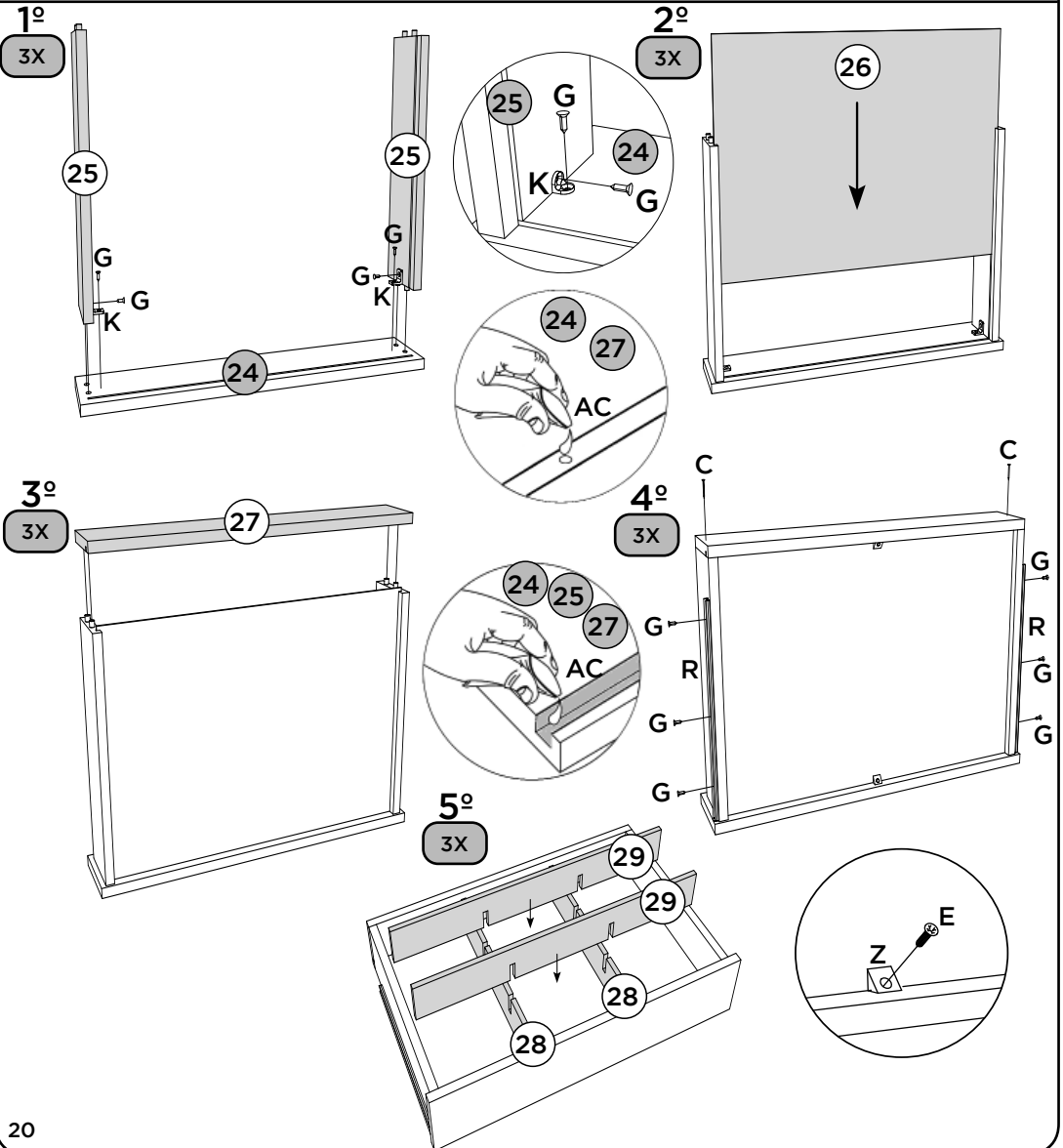

**LISTA DE PEÇAS** | LISTA DE PIEZAS | LIST OF PIECES

Item	Caixa Caja Box	Qty Ctd Qty	Descrição Descripción Description	Dimensões (mm)   Dimensiones (mm)   Dimensions (mm)		
				Comprimento Largo Length	Largura Ancho Width	Espessura Grosor Thickness
36	5/7	12	TRAVESSA   TRAVESAÑO   RAIL	400	35	25
37	6/7	2	PAINEL CENTRAL   PANEL CENTRAL   CENTRAL PANEL	1275	549	12
38	6/7	2	PAINEL INFERIOR SUPERIOR   PANEL INFERIOR SUPERIOR   UPPER LOWER PANEL	1275	549	12
39	6/7	2	PAINEL CENTRAL ESPELHO   PANEL CENTRAL CON ESPEJO   MIRRORRED CENTRAL PANEL	1275	549	12
40	6/7	2	PAINEL INFERIOR SUPERIOR ESPELHO   PANEL INFERIOR SUPERIOR CON ESPEJO   UPPER LOWER MIRRORRED PANEL	1275	549	12
41	7/7	4	ESPELHO   ESPEJO   MIRROR	1250	540	3

**VISTA EXPLODIDA DAS PEÇAS** | VISTA DESPIECE DE LAS PIEZAS | EXPLODED VIEW OF THE PARTS.

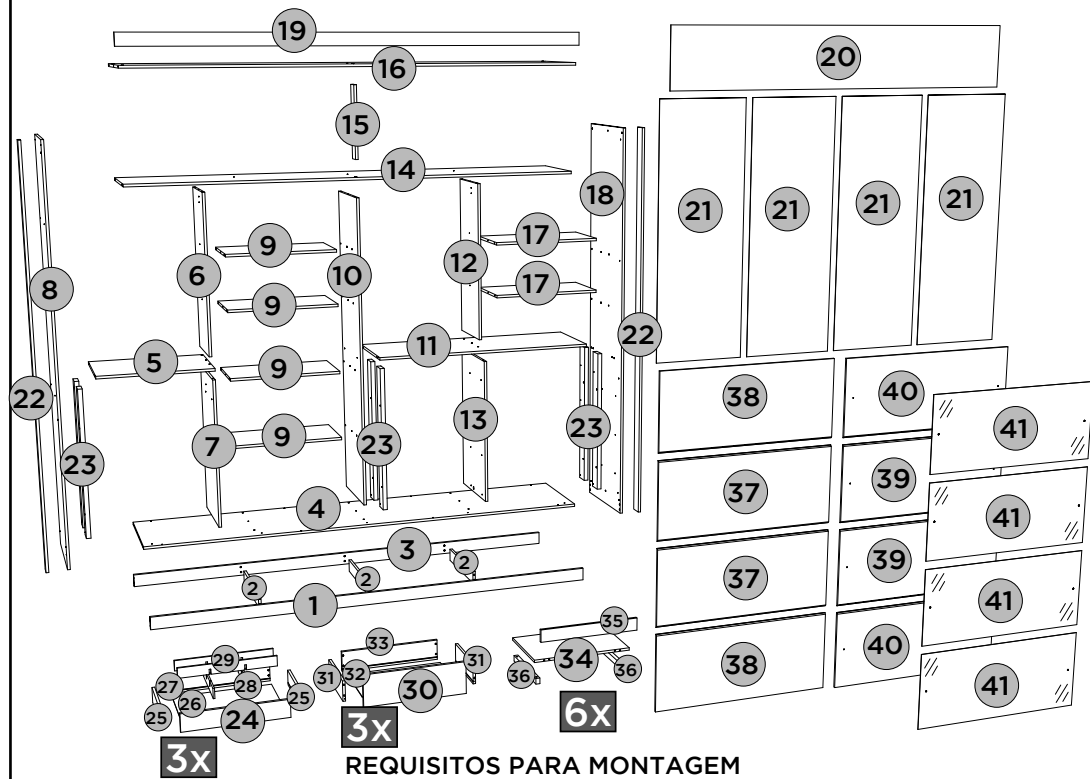

**REQUISITOS PARA MONTAGEM**  
REQUISITOS PARA LA MONTAJE | ASSEMBLY REQUIREMENTS.

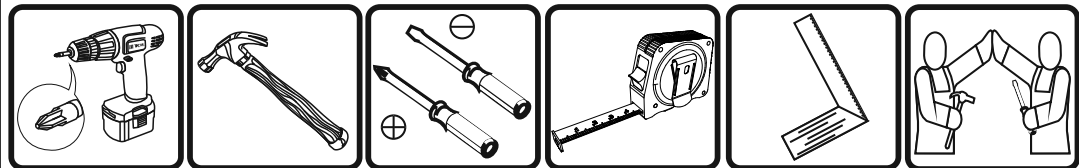

Imagens meramente ilustrativas, não acompanha o produto.  
Imágenes ilustrativas, no incluidas con el producto.  
Illustrative images, not included with the product.

PEÇAS REQUERIDAS

ACESSÓRIOS REQUERIDOS

FERRAMENTAS NECESSÁRIAS

1	RODAPÉ FRONTAL	x1
2	TRAVESSA DO RODAPÉ	x3
3	RODAPÉ TRASEIRO	x1
15	RIPA DO MALEIRO	x1
25	LADO DE GAVETA	x6
31	LADO DE GAVETA MAIOR	x6
35	TRAVESSA FRONTAL	x6
36	TRAVESSA	x12

H		12
J		94
AC		

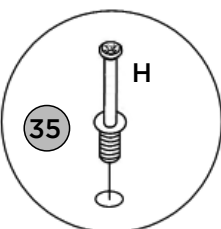
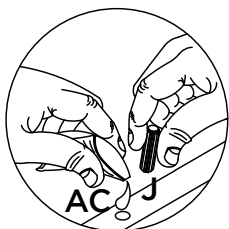
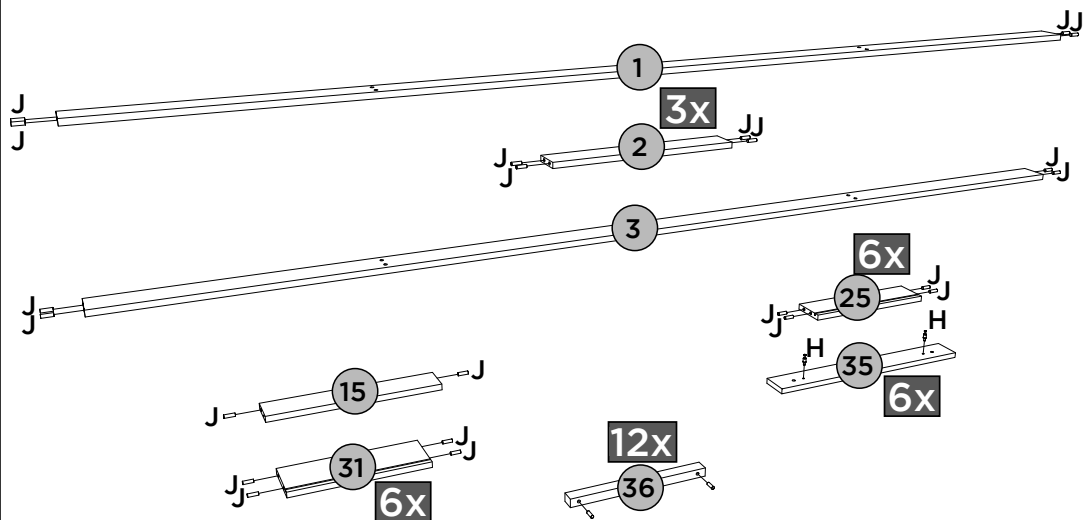
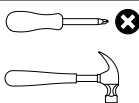

ACESSÓRIOS REQUERIDOS

FERRAMENTAS NECESSÁRIAS

G		42	T		02
R		13	X		01
S		01	Y		01

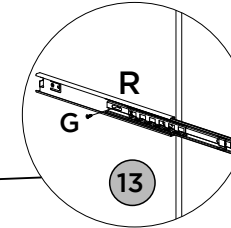
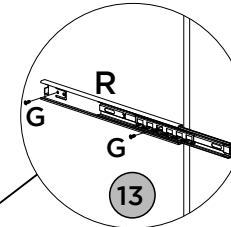
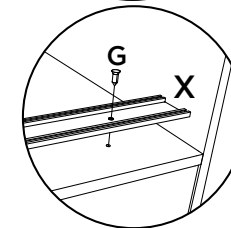
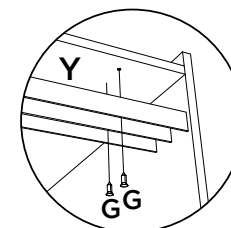
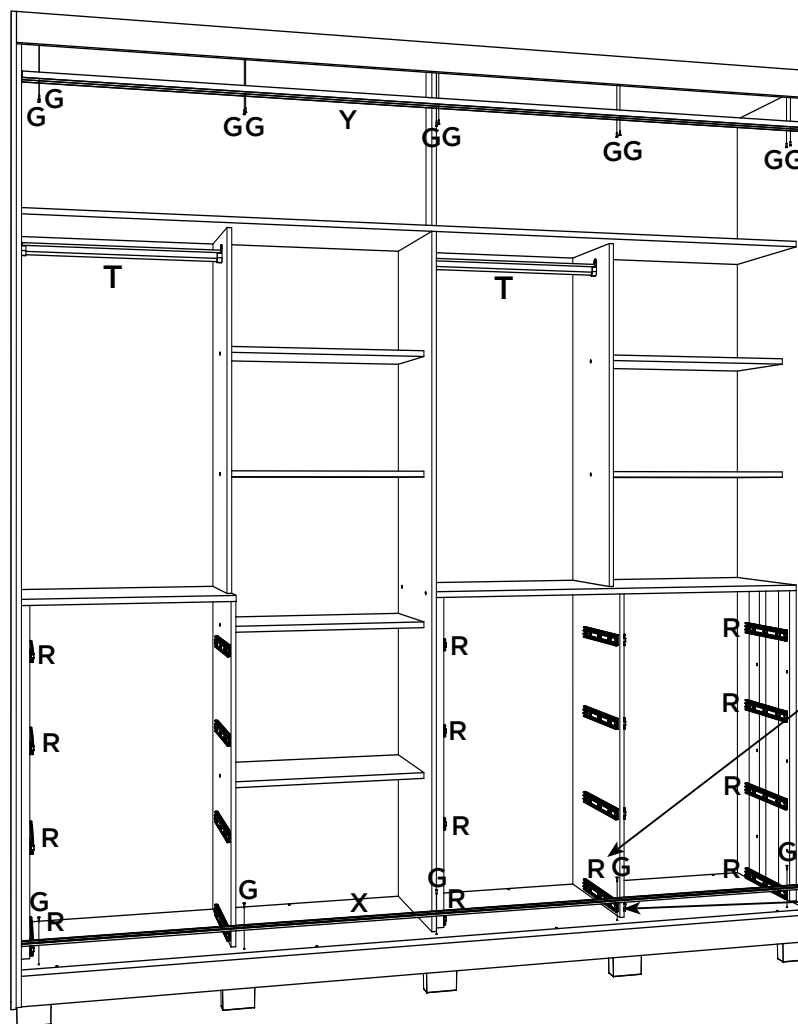
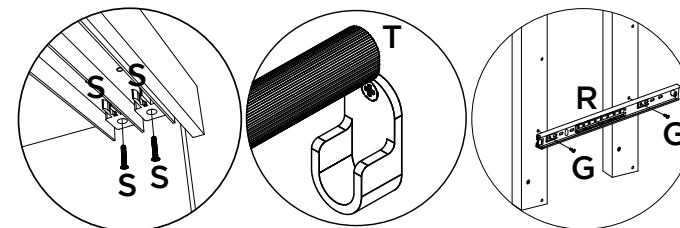
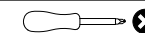

PEÇAS REQUERIDAS

ACESSÓRIOS REQUERIDOS

FERRAMENTAS NECESSÁRIAS

22	RIPA LATERAL	x6
23	MOLDURA LATERAL	x2

C		18
D		08

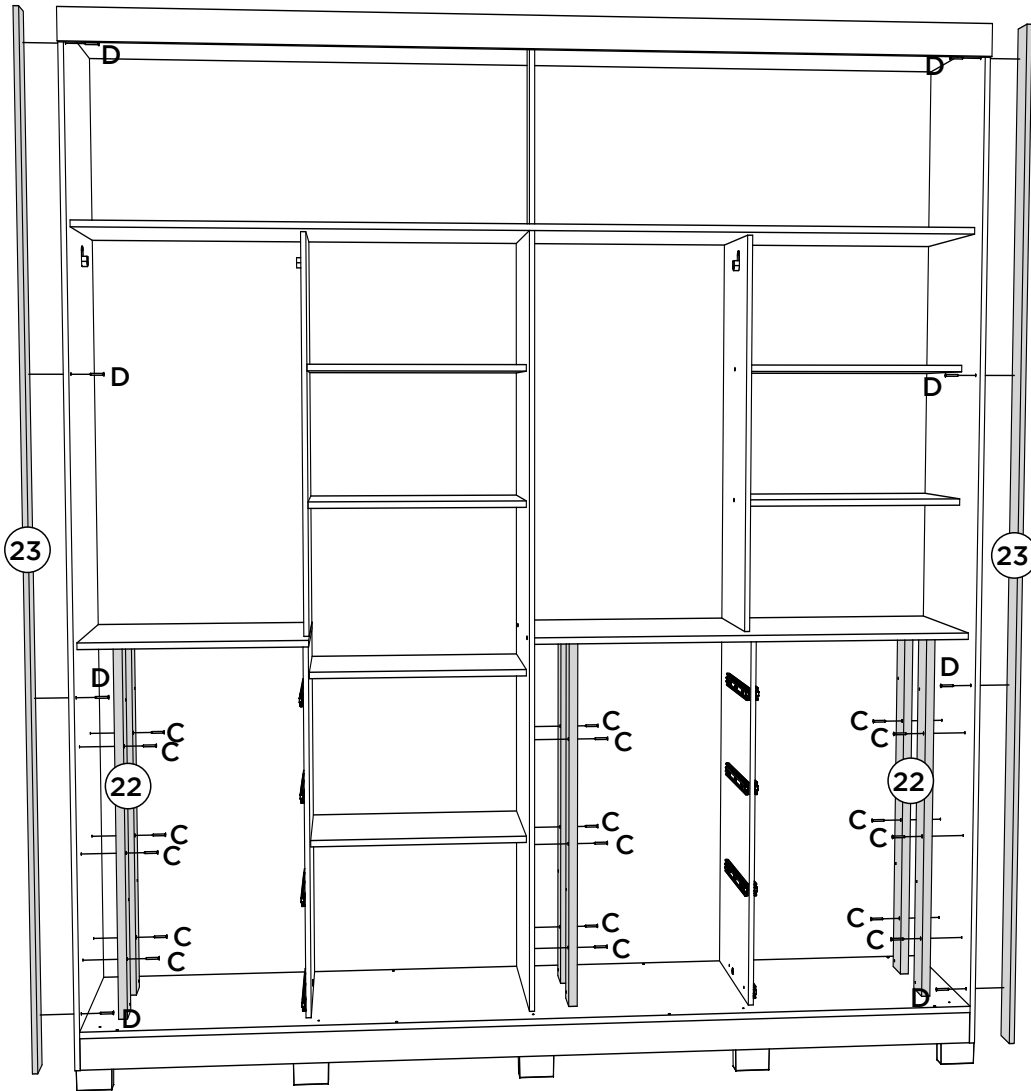
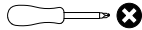

Moldura Lateral 23 deve ficar alinhada com o chapéu 19.  
 El marco lateral 23 debe estar alineado con el sombrero 19.  
 Side frame 23 must be aligned with hat 19.

PEÇAS REQUERIDAS

ACESSÓRIOS REQUERIDOS

FERRAMENTAS NECESSÁRIAS

4	BASE	x1
8	LATERAL ESQUERDA	x1
10	DIVISÃO	x1
14	CHÃO DO MALEIRO	x1
16	TAMPO	x1

G		04
H		03
J		12
L		08
M		02
AC		

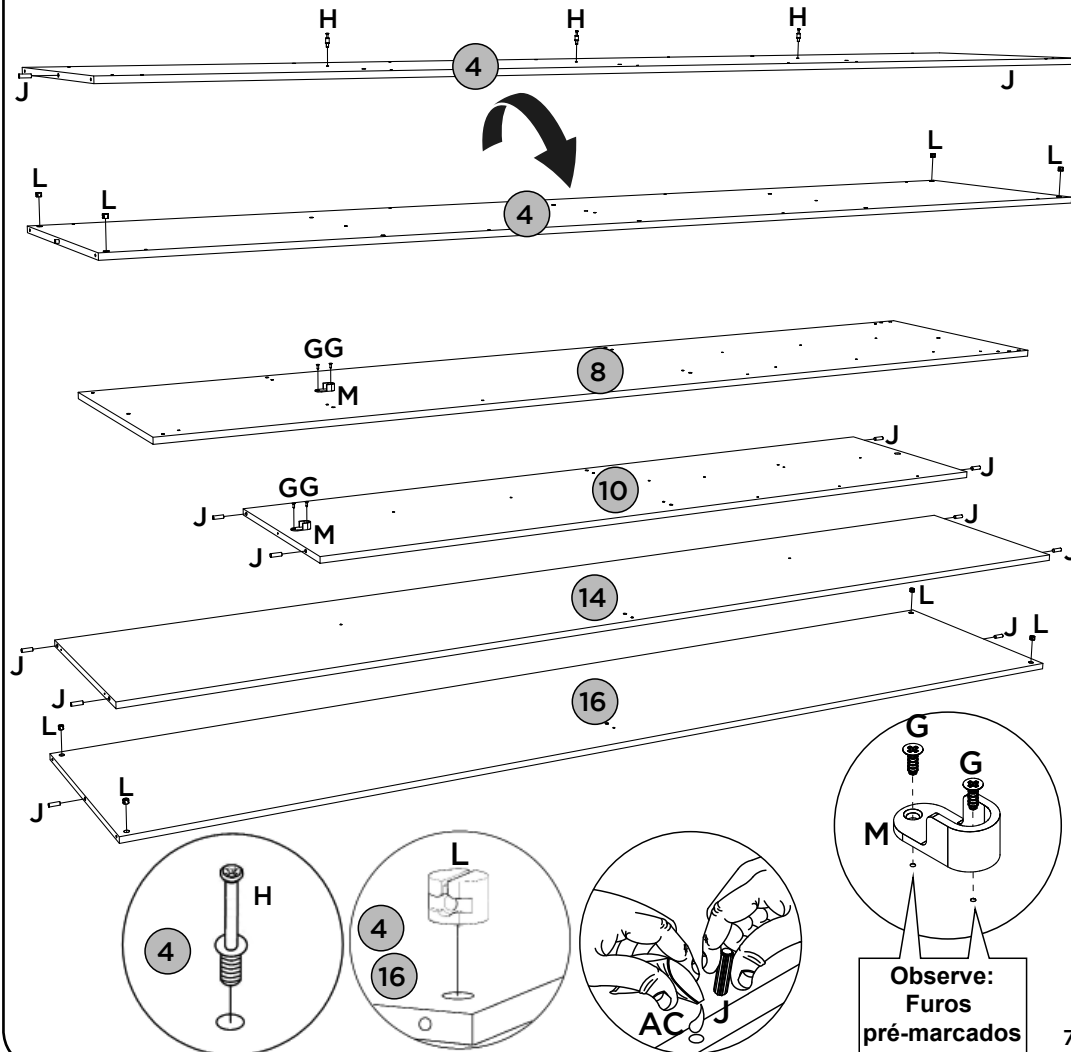
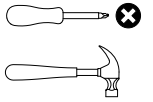

Observe:  
Furos pré-marcados

PEÇAS REQUERIDAS

ACESSÓRIOS REQUERIDOS

FERRAMENTAS NECESSÁRIAS

5	TAMPO DAS GAVETAS ESQUERDA	x1
6=12	DIVISÃO SUPERIOR	x2
7	DIVISÃO INFERIOR ESQUERDA	x1
9=17	PRATELEIRA	x6
11	TAMPO DAS GAVETAS DIREITA	x1
13	DIVISÃO INFERIOR DIREITA	x1
34	PRATELEIRA MÓVEL	x6

G		34
J		58
M		02
R		10
AC		

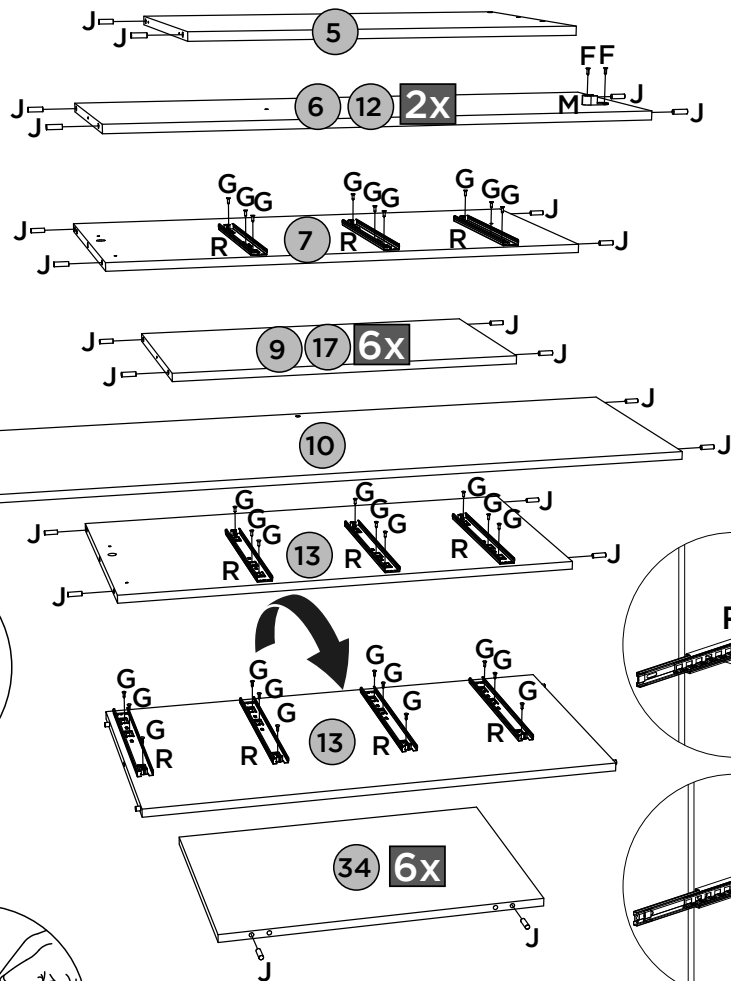
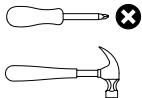

Observe:  
Furos  
pré-marcados

Fixar as correias nessas furações  
Fijar las diapositivas de estos agujeros  
Fix the slides in these holes

PEÇAS REQUERIDAS

ACESSÓRIOS REQUERIDOS

FERRAMENTAS NECESSÁRIAS

19	CHAPÉU	x1
20	FUNDO SUPERIOR	x1
21	FUNDO	x4

G		08
K		04
O		228
P		80

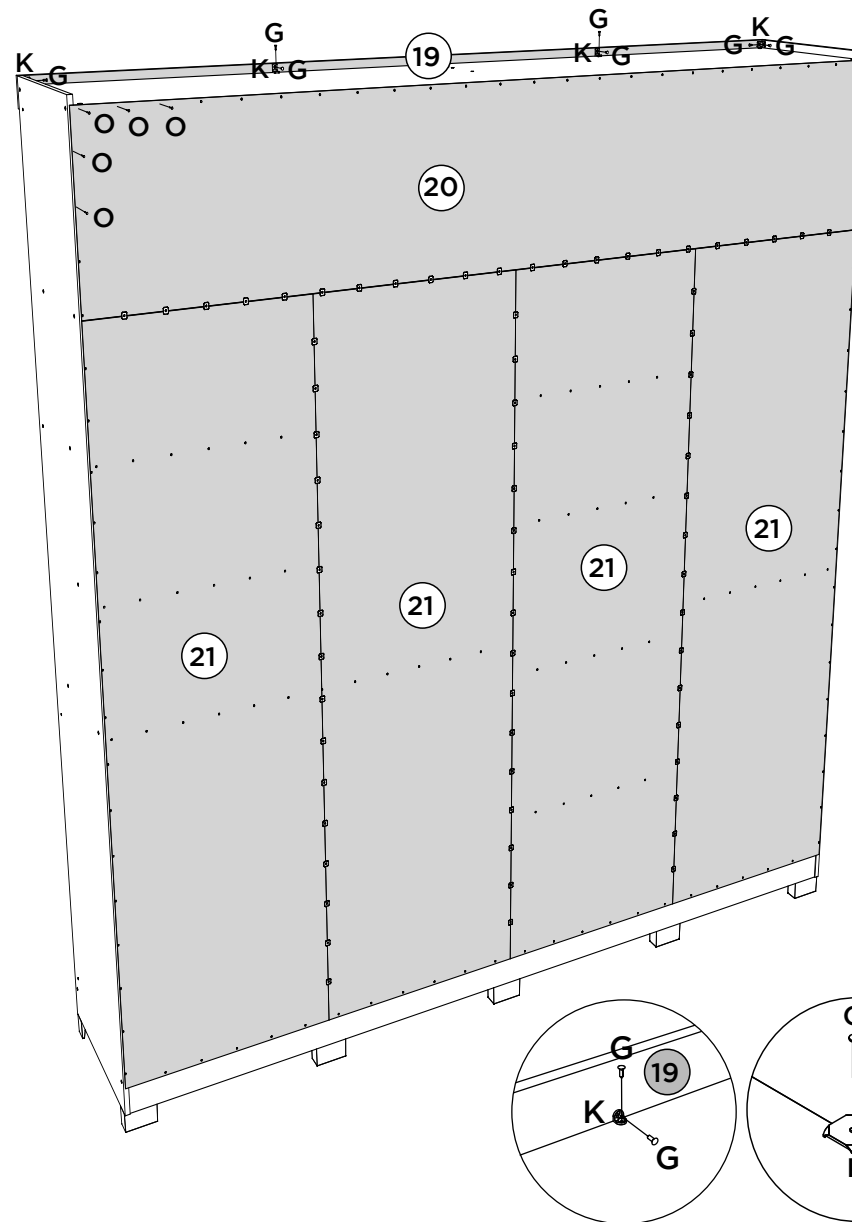
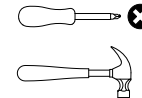



PEÇAS REQUERIDAS

ACESSÓRIOS REQUERIDOS

FERRAMENTAS NECESSÁRIAS

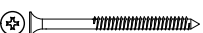
16	TAMPO	x1
17=9	PRATELEIRA	x2
18	LATERAL DIREITA	x1

A		06
B		09

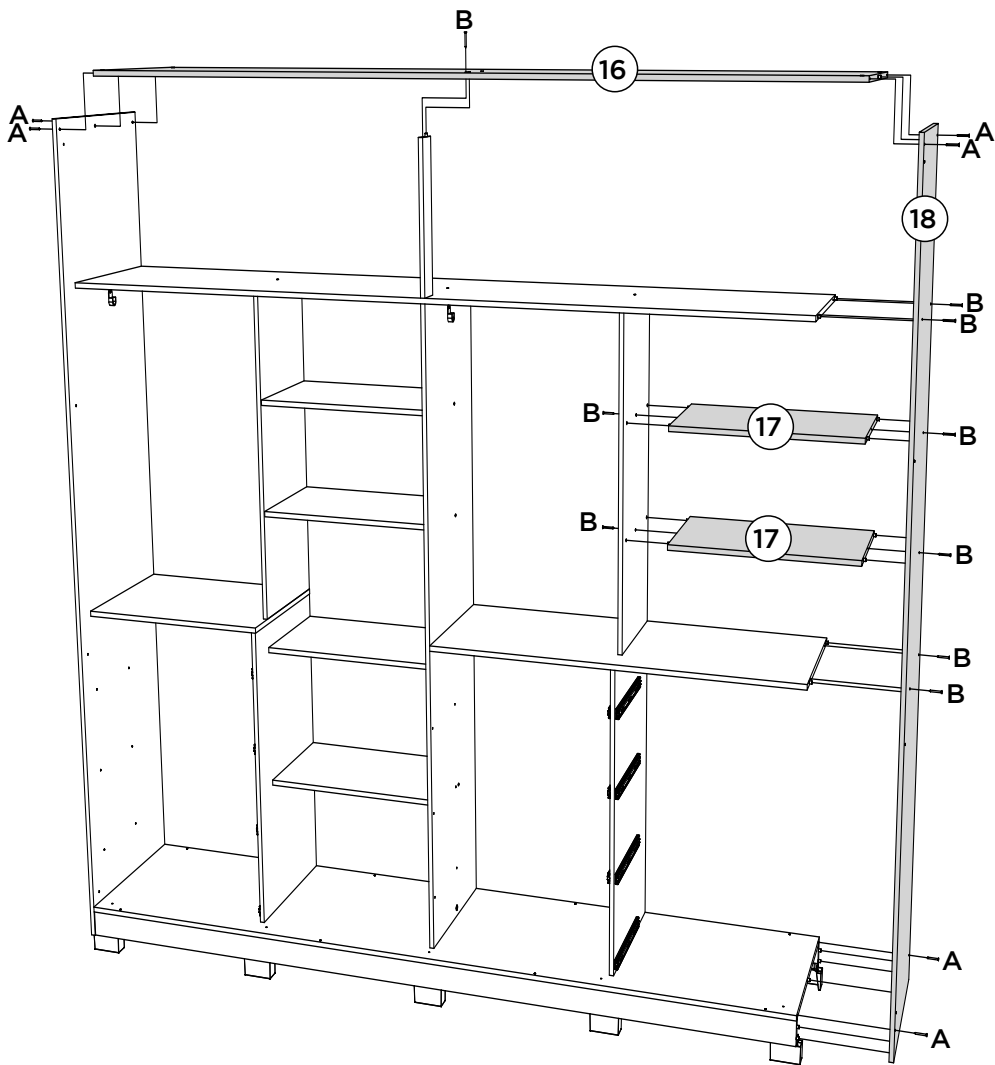
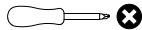





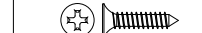

PEÇAS REQUERIDAS

ACESSÓRIOS REQUERIDOS

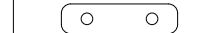
FERRAMENTAS NECESSÁRIAS

37	PAINEL CENTRAL	x2
38	PAINEL INFERIOR SUPERIOR	x2

E		06
G		30
U		12
V		01
W		01
S		01

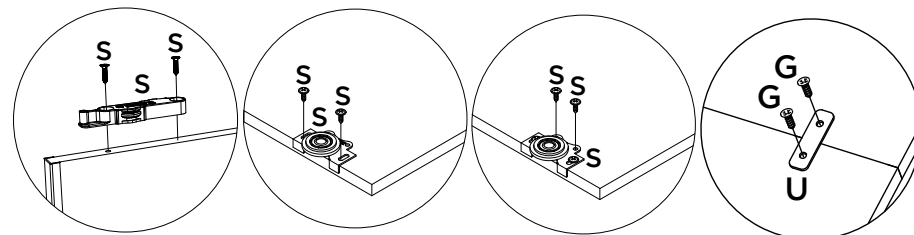
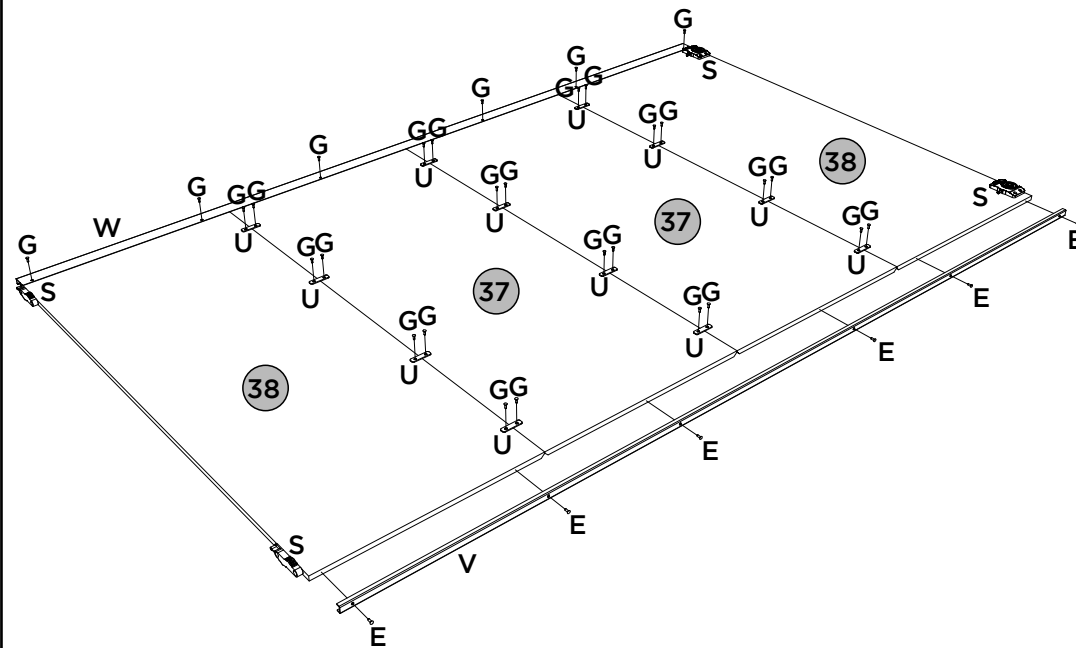

PEÇAS REQUERIDAS

39	PAINEL CENTRAL ESPELHO	x2
40	PAINEL INFERIOR SUPERIOR ESPELHO	x2
41	ESPELHO	x4

ACESSÓRIOS REQUERIDOS

E		06
F		08
G		30
N		08
U		12
V		01
W		01
S		01

FERRAMENTAS NECESSÁRIAS

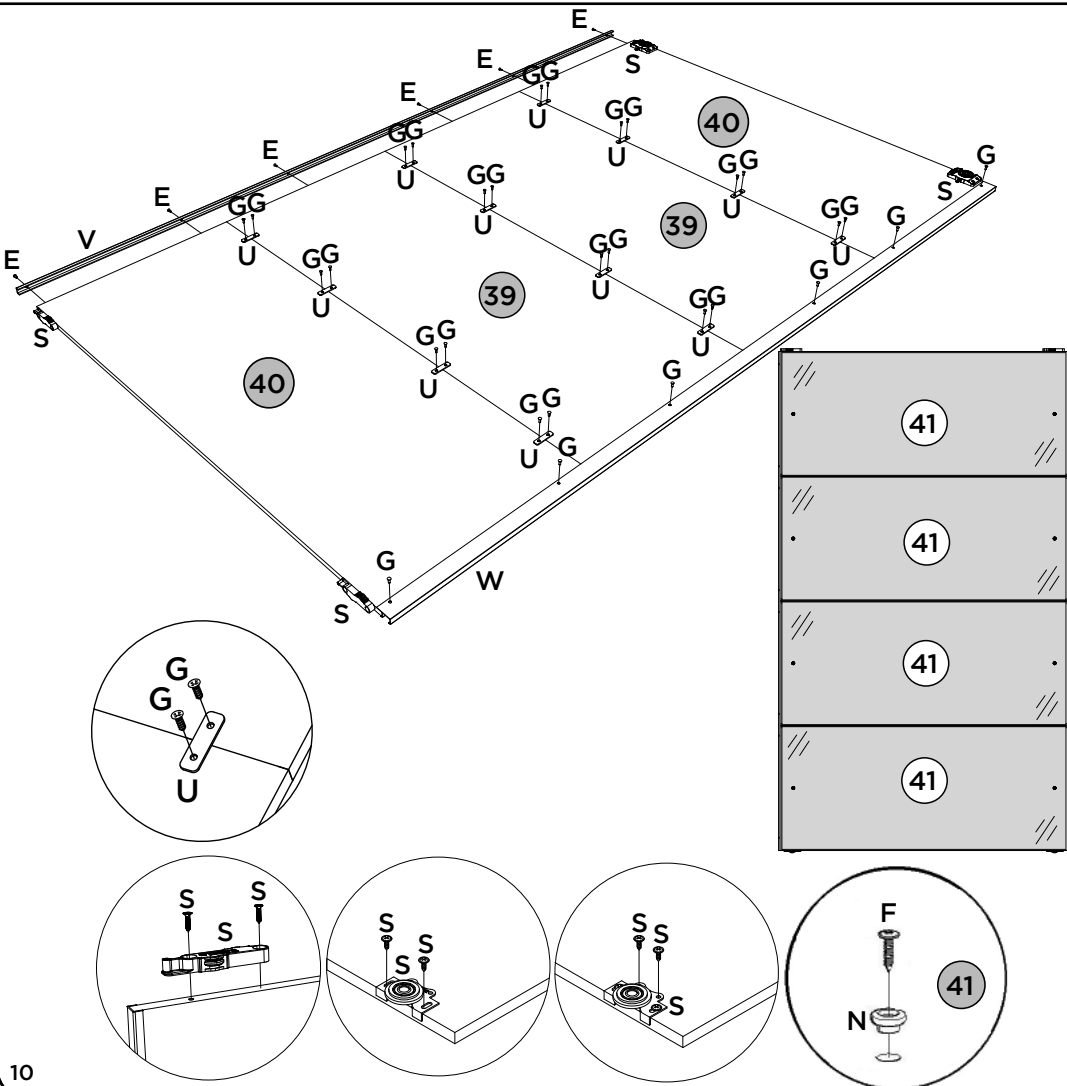
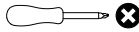

PEÇAS REQUERIDAS

14	CHÃO DO MALEIRO	x1
15	RIPA DO MALEIRO	x1

ACESSÓRIOS REQUERIDOS

B		06
---	--	----

FERRAMENTAS NECESSÁRIAS

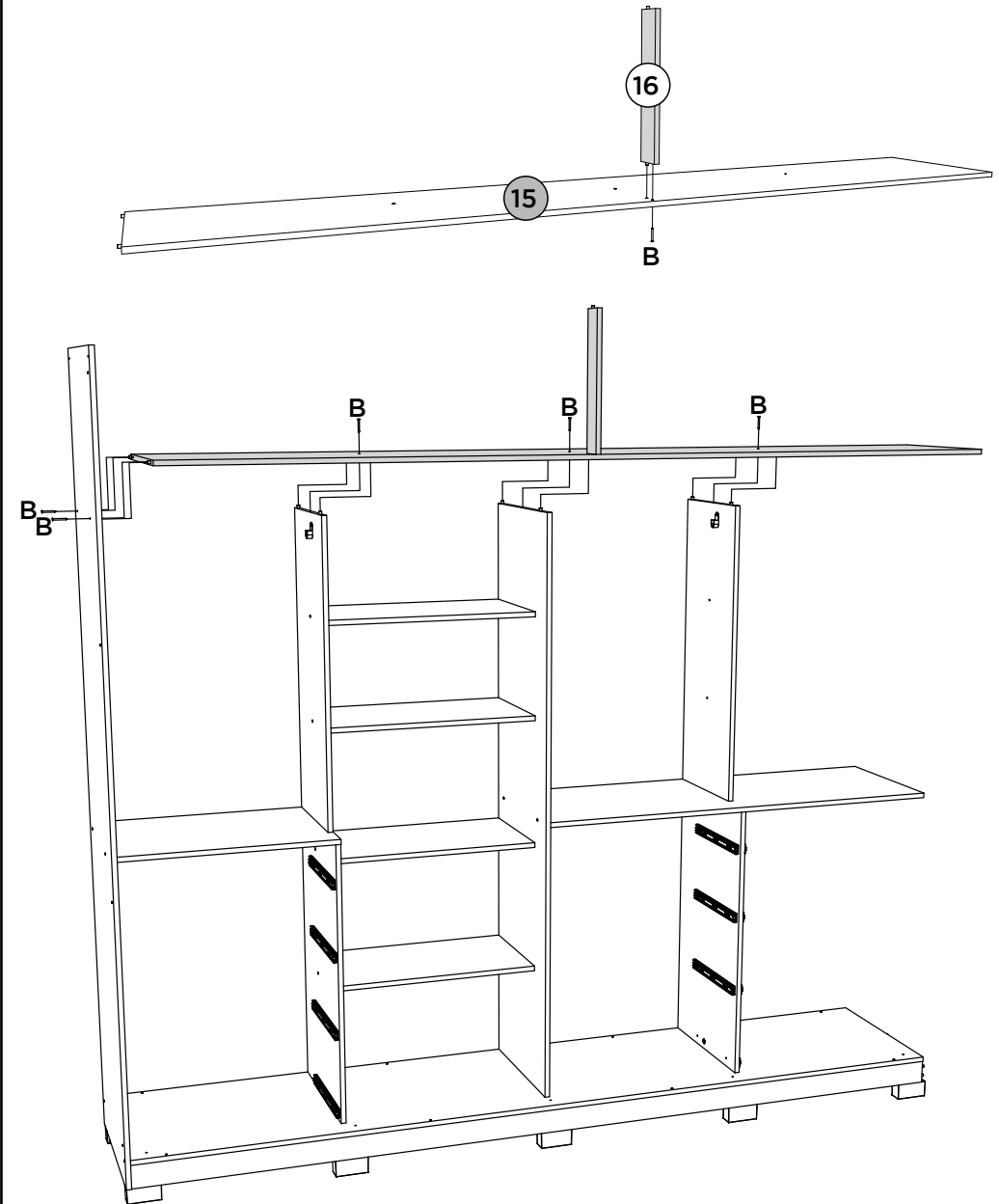

**PEÇAS REQUERIDAS**

11	TAMPO DAS GAVETAS DIREITA	x1
12=6	DIVISÃO SUPERIOR	x1
13	DIVISÃO INFERIOR DIREITA	x1

**ACESSÓRIOS REQUERIDOS**

B		03
G		02
I		01
K		01

**FERRAMENTAS NECESSÁRIAS**

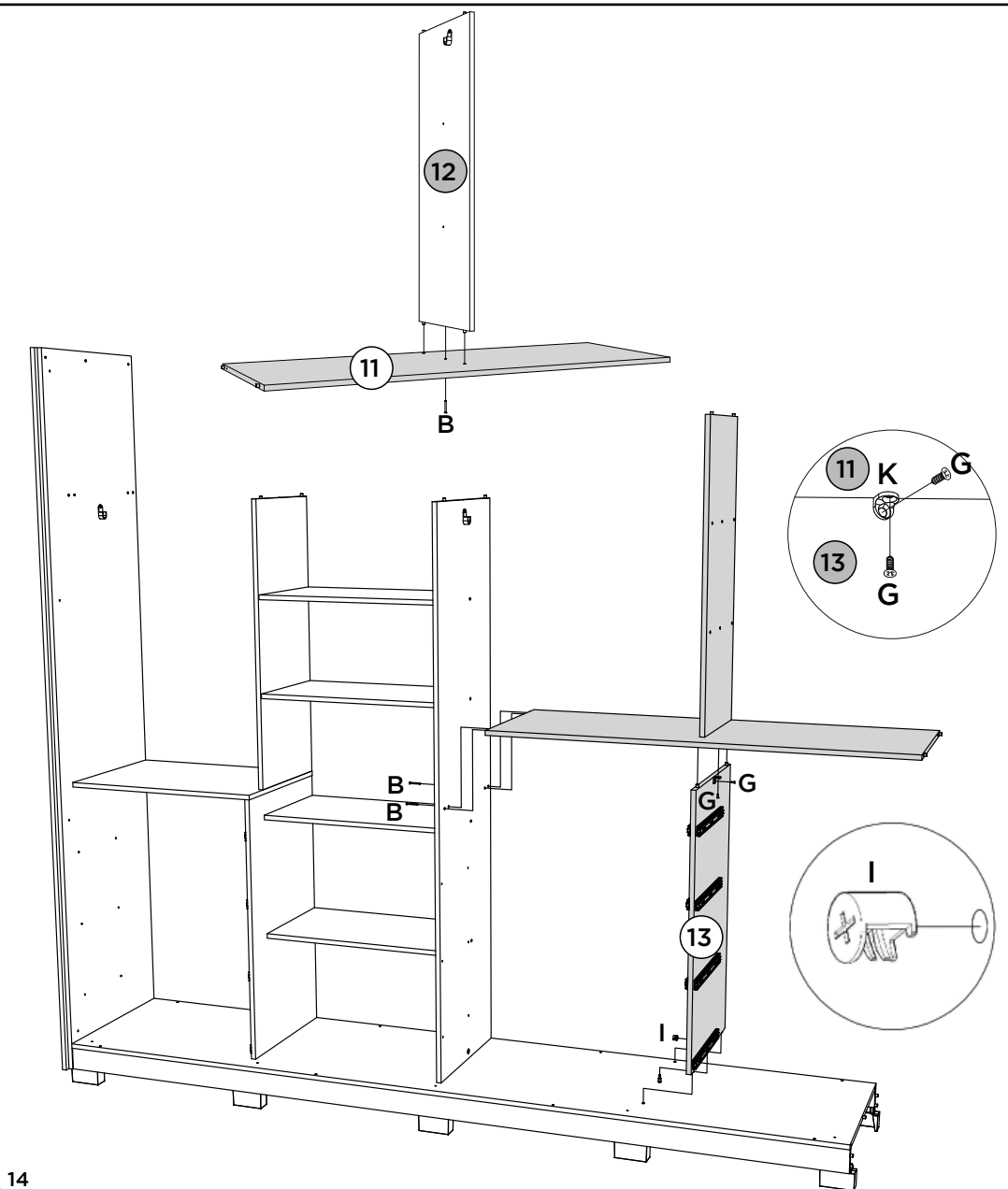
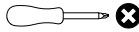

**PEÇAS REQUERIDAS**

1	RODAPÉ FRONTAL	x1
2	TRAVESSA DO RODAPÉ	x3
3	RODAPÉ TRASEIRO	x1

**ACESSÓRIOS REQUERIDOS**

G		12
K		06

**FERRAMENTAS NECESSÁRIAS**

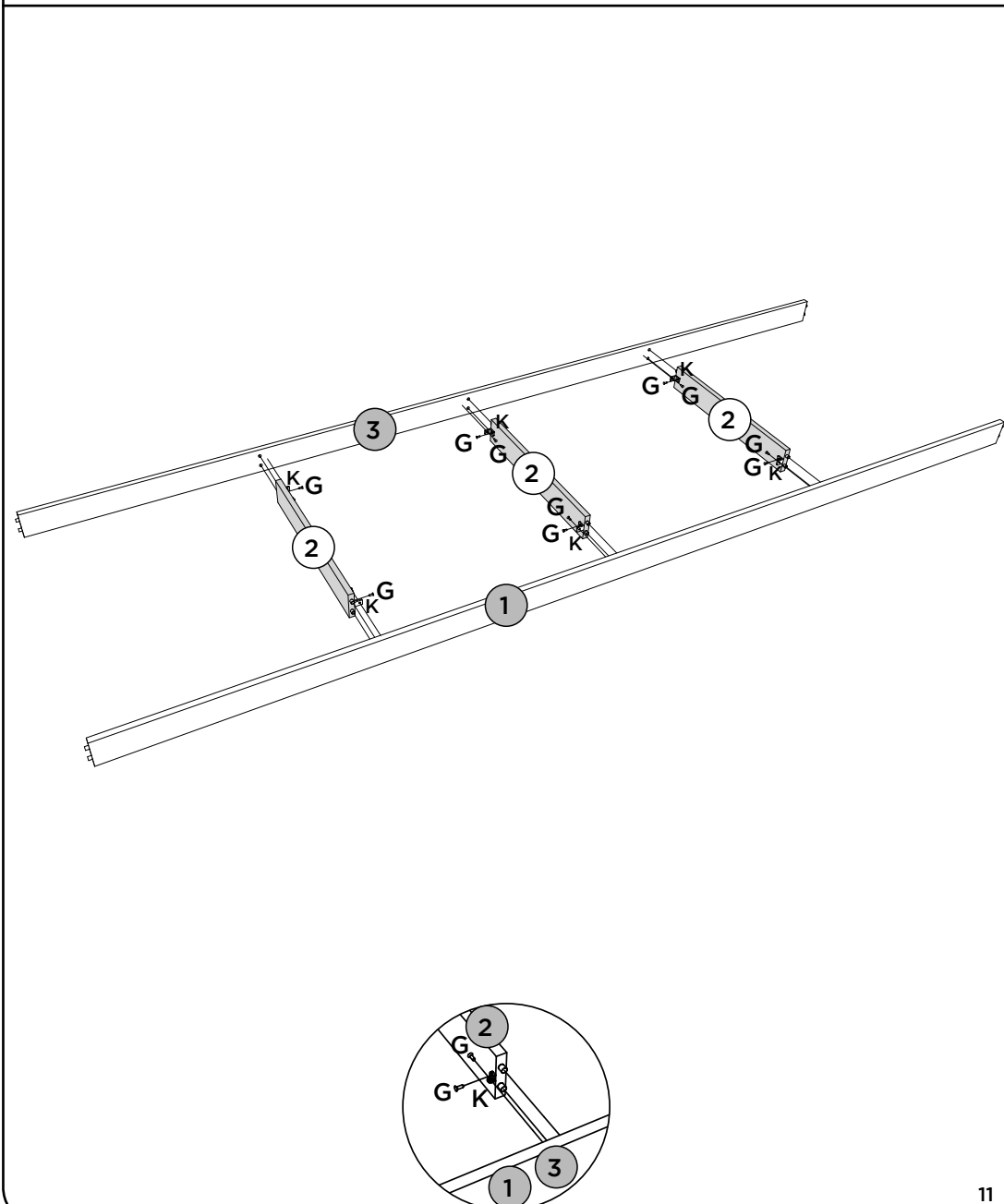

PEÇAS REQUERIDAS

4	BASE	x1
5	TAMPO DAS GAVETAS ESQUERDA	x1
6	DIVISÃO SUPERIOR	x1
7	DIVISÃO INFERIOR ESQUERDA	x1
8	LATERAL ESQUERDA	x1

ACESSÓRIOS REQUERIDOS

A		02
B		03
C		08
G		32
I		01
K		01
Q		10

FERRAMENTAS NECESSÁRIAS

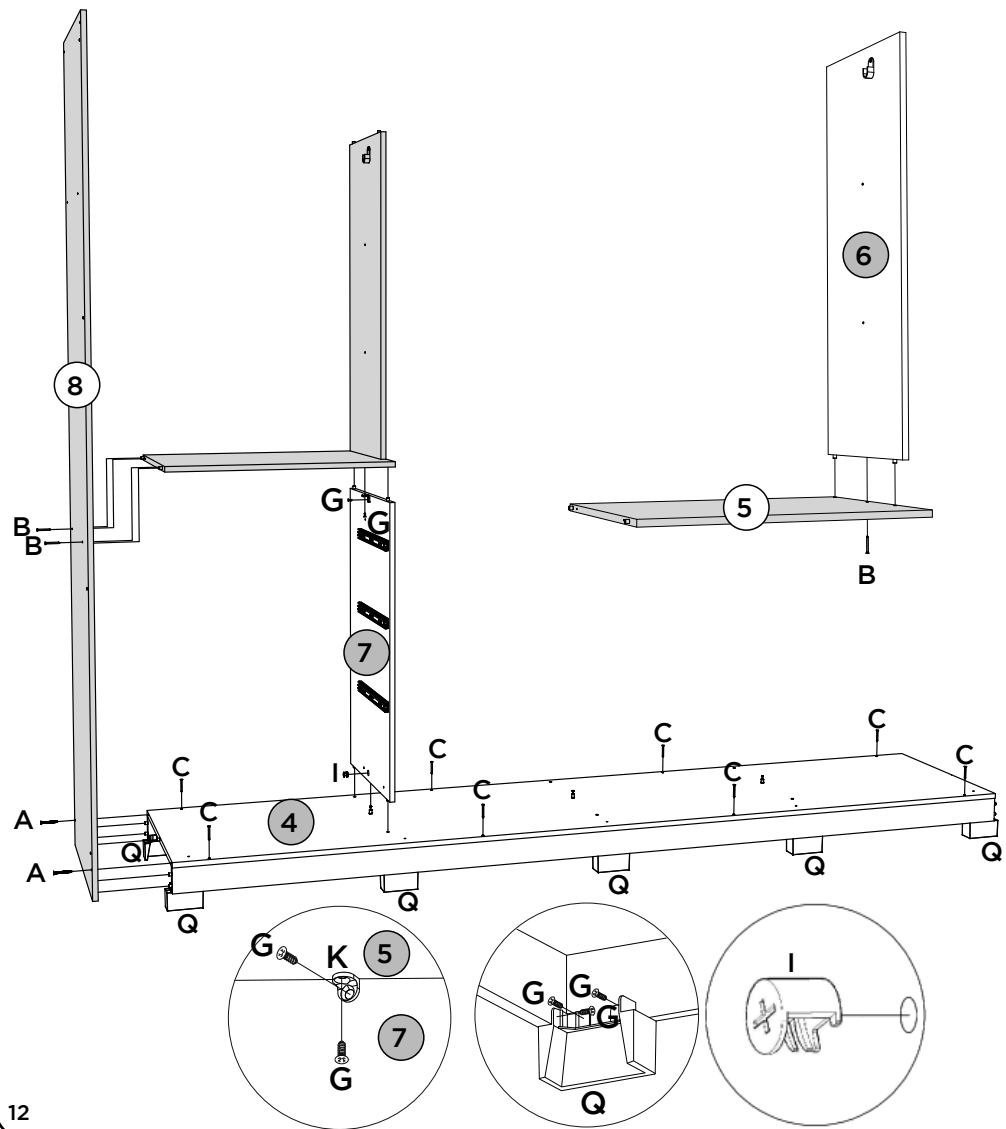
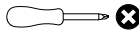

PEÇAS REQUERIDAS

9	PRATELEIRA	x4
10	DIVISÃO	x1

ACESSÓRIOS REQUERIDOS

B		08
G		03
I		01
R		01

FERRAMENTAS NECESSÁRIAS

