







ASSEMBLY INSTRUCTION

(1) X1	(2) X1	(3) X1
		
(4) X1	(5) X1	(6) X5
		

Ax4  M6X18

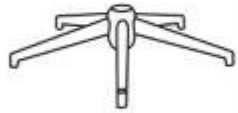
Bx4  M8X45

Cx4 

M8 

M6 

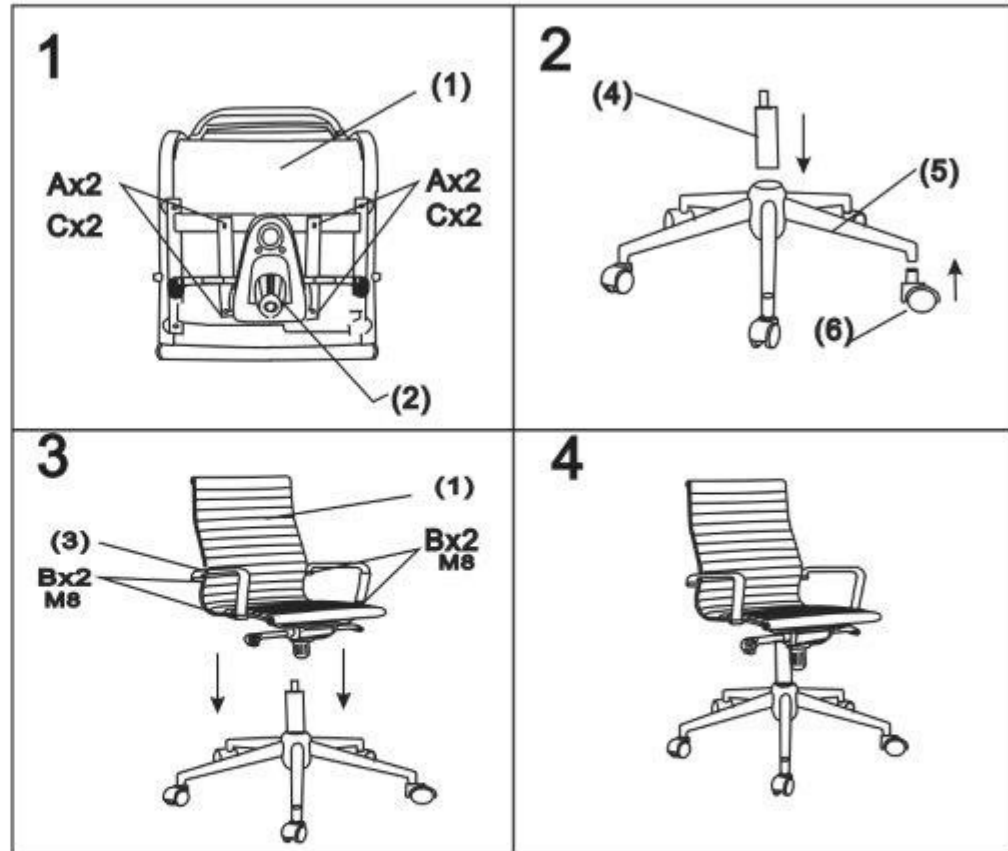

It is important to assemble all parts so that the directional "Arrows" point in the same direction. Make certain that all screws are FULLY tightened before using the chair. Each month check all screws and tighten and that may have loosened.

Warning: Do not stand on the chair for any purpose. □