



Instruções de Montagem / Instrucciones de Armado / Assembly Instructions

1395 - Guarda Roupa Infantil 2 Portas 2 Gavetas com Nicho
 1395 - Guardarropa Infante 2 Puertas 2 Cajones com Nicho
 1395 - Baby's Wardrobe 2 Doors 2 Drawers with Niche

Lançamento 01/01/2017
 Lanzamiento/Release

Atualização 20/06/2017
 Actualización/Update

Aspecto Final
 Aspecto Final / Final Appearance

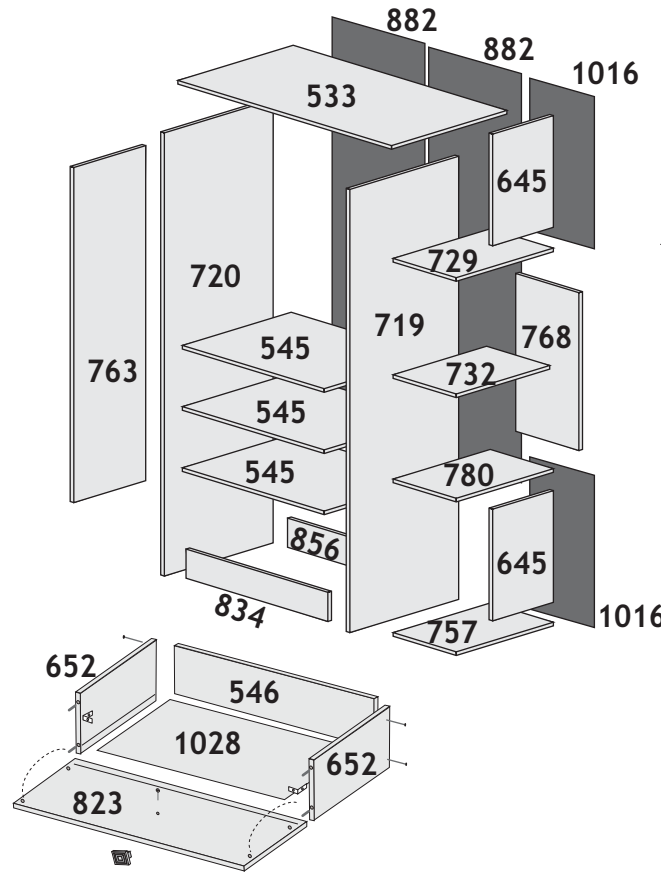

Componentes Componentes / Components

Cód.	Peças	Piezas	Parts	MMxMM	Qt.
533	Chapéu	Cubierta	Cover	880x475	01
545	Prateleira	Repisa	Shelf	584x448	03
719	Lateral Direita	Lateral Derecha	Right Side	1825x448	01
720	Lateral Esquerda	Lateral Izquierda	Left Side	1825x448	01
652	Lateral Gaveta	Lateral del Cajon	Side of Drawer	347x110	04
546	Contra Fundo	Trasero del Cajon	Drawer Rear	535x80	02
834	Rodape	Rodapie	Footer	584x120	01
856	Rodape Traseiro	Rodapie Trasero	Rear Footer	584x120	01
882	Forro Traseiro	Fondo	Back	1720x298	02
1016	Forro Nicho	Fondo Nicho	Back Niche	485x260	02
1028	Fundo Gaveta	Fondo del Cajon	Bottom of Drawer	558x352	02
645	Lateral Cantoneira	Lateral Canto	Corner Side	460x250	02
729	Cantoneira Superior	Canto Superior	Upper Corner	400x260	01
732	Cantoneira Central	Canto Central	Center Corner	385x260	01
757	Cantoneira Inferior	Canto Inferior	Bottom Corner	400x260	01
780	Cantoneira Intermediária	Canto Intermedio	Intermediate Corner	400x260	01
823	Frente Gaveta	Frente del Cajon	Drawer Front	592x158	02
763	Porta	Puerta	Door	1380x296	02
768	Apoio da Cantoneira	Apoyo del Canto	Corner support	650x260	01
Cód.	Acessórios	Accesorios	Accessories	MMxMM	Qt.
AC	Parafuso Chato	Tornillo de Cabeza Plana	Flat Head Screw	3,5 x 12	60
AE	Parafuso Chato	Tornillo de Cabeza Plana	Flat Head Screw	4 x 40	21
AG	Parafuso Flangeado	Tomillo de Cabeza Flangeado	Flanged Head Screw	3,5 x 30	06
AJ	Perfil H	Perfil H	'H' Profile	1705 x 16	01
AT	Prego	Clavo	Nail	10 x 10	40
AU	Prego	Clavo	Nail	12 x 12	16
BC	Sache Cola	Cola	Paste	-	01
BH	Tapa Furo Adesivo	Taponos Adhesivo	Bore patch adhesive	-	11
BE	Suporte Cabideiro	Soporte Perchero	Clothes rack support	-	02
BU	Cabideiro	Perchero	Clothes rack	-	01
CA	Corrediça Metalica	Corredera	Metalic Slide	-	02
D	Cantoneira Metalica	Soporte de Metal	Metal Bracket	18 x 18	04
H	Cavilha	Pin	Wooden Dowel	6 x 30	54
P	Dobradiça	Bisagra	Hinge	-	06
U	Mini Sapata	Pie Plastico	Small plastic foot	-	04
	Puxador	Tirador	Handle		03

Cores Disponíveis / Colores Disponibles / Available Colors

003 - BRANCO / BRANCO BLANCO / BLANCO - WHITE / WHITE
 125 - CARVALHO / BRANCO ROBLE / BLANCO - OAK / WHITE



+55 (43) 3303-8100



assistencia@qmovi.com.br



www.qmovi.com.br

Recomendações

Recomendaciones

Recommendations

01 - Aconselhamos que a montagem seja feita por um montador profissional.
 02 - Utilize a embalagem para forrar o chão e iniciar a montagem.
 03 - Separe as peças colocando em pé, nunca empilhe uma sobre a outra.
 04 - Identifique as peças do móvel e sua numeração antes de iniciar a montagem.
 05 - Ao solicitar assistência, informe a referência da peça, o modelo, a cor do móvel corretamente e o número do Lote. Solicite a assistência diretamente a fábrica.

01 - Se recomienda que el montaje se realiza por un instalador profesional.
 02 - Utilizar el material de embalaje para cubrir el suelo e iniciar el montaje.
 03 - Separar las piezas que ponen en pie, nunca se apilan unas sobre otras.
 04 - Identificar las partes móviles y sus números ante de comenzar ensamblaje.
 05 - Al solicitar asistencia, introduzca la referencia de la pieza, modelo, color, móvil correctamente y el número del lote. Solicitar la ayuda directamente a la fábrica.

#1 - We recommend that the mounting is done by a professional fitter.
 #2 - Use packaging material to cover the floor and start the assembly.
 #3 - Separate the pieces putting on foot, never stack on each other.
 #4 - Identify the mobile parts and their numbers before starting assembly.
 #5 - When requesting assistance, enter the part reference, model, color, mobile correctly and the number of the lot. Request assistance directly to the factory.

01

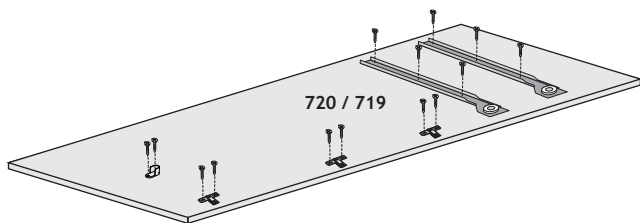
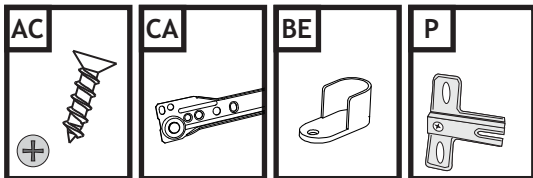

02

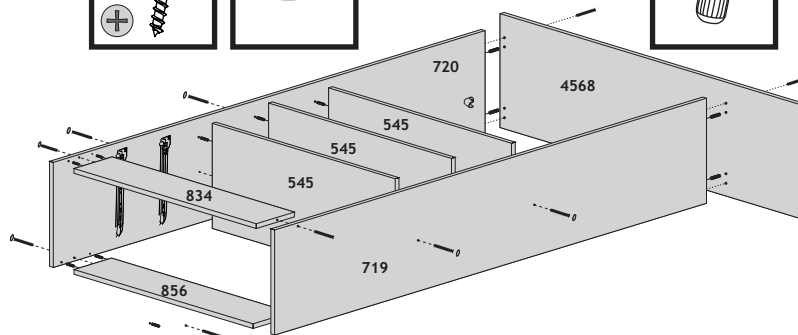
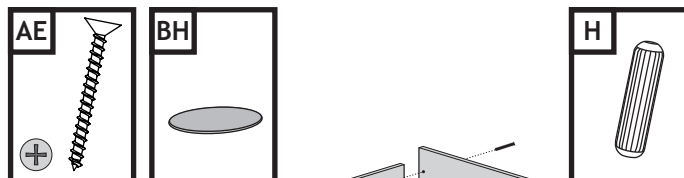

03

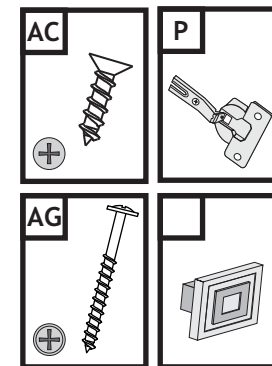
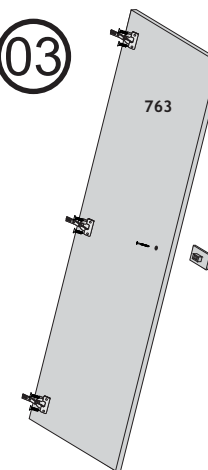

04

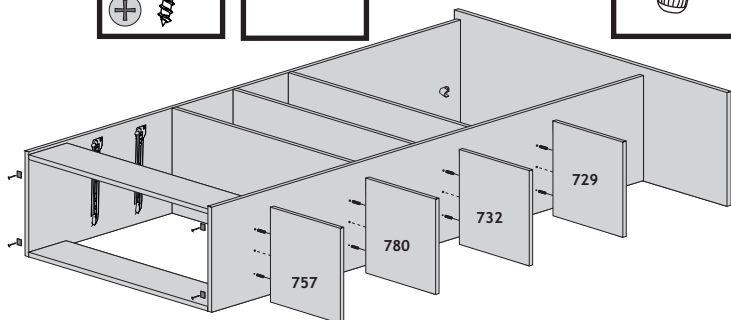
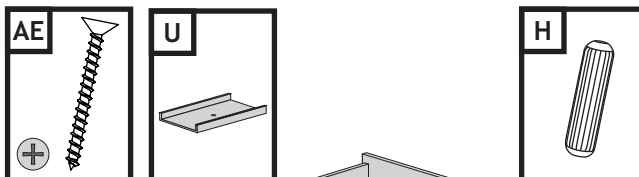

05

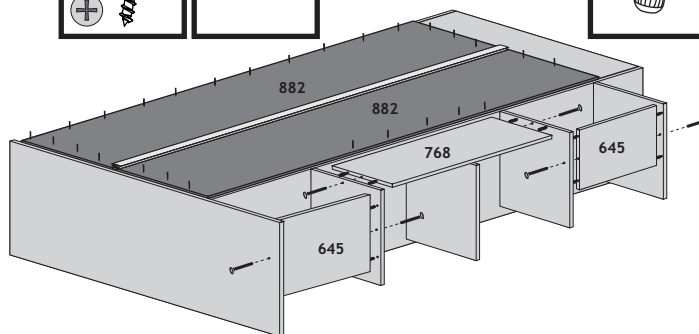
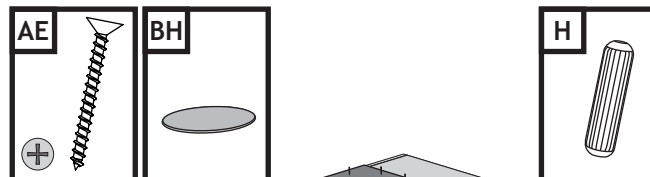

06

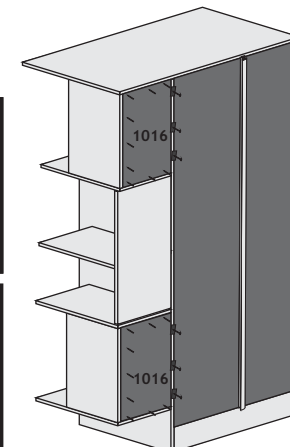
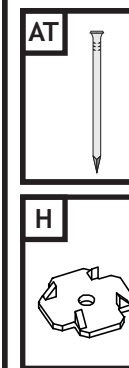

07

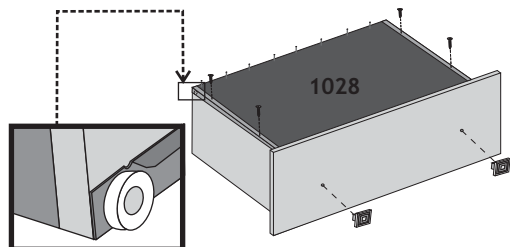
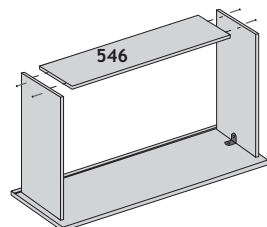
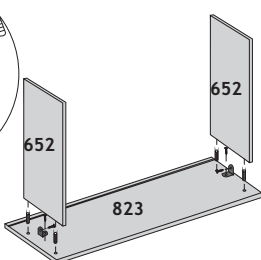
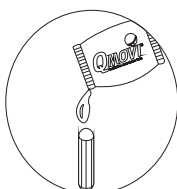
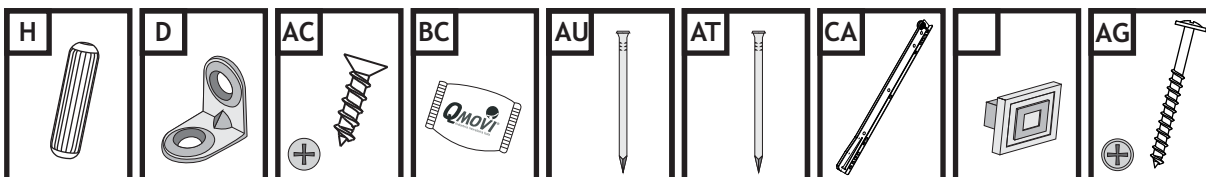

08

Observar se o parafuso de regulagem da porta encaixou no calço da dobradiça.
 Asegúrese de que el tornillo el ajuste de la puerta incrustado en la cuña bisagra.
 Make sure the screw Door adjustment embedded in the wedge hinge.

