

08

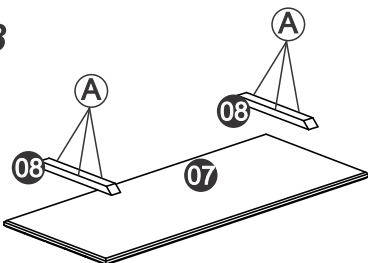

09

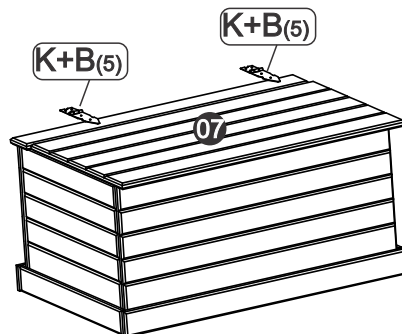

10

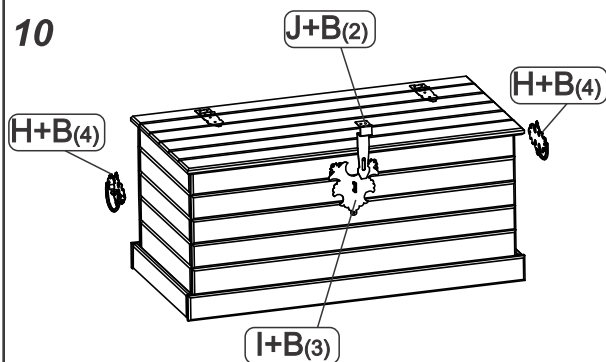

11

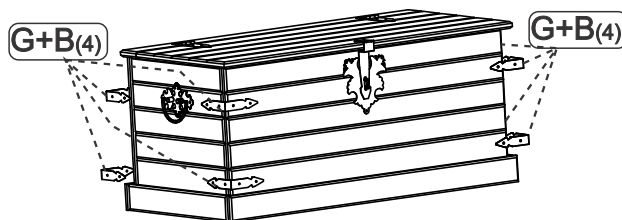

#### Como cuidar de seu móvel

Móvel adequado para uso doméstico.  
Limpar com um pano seco, não utilize produtos que contenham solventes abrasivos ou amoníacos.

Evitar a exposição da luz solar e umidade excessiva. A cor do produto, as vetas e rasgos da madeira poderá ter alguns tipos de variações depois de algum tempo, isto é natural devido a alterações climáticas.

#### Como cuidar de su Mueble

Mueble adecuado para uso doméstico.  
Limpie siempre con un paño seco, no utilice productos que contengan soluciones solventes ni amoníacos.

Evite la exposición directa al sol ó en ambientes húmedos.

El color y algunas características de la propia madera poderán tener algun tipo de alteración, esto es natural debido a las mudanzas naturales del clima.

#### How to care for your furniture

Furniture suitable for domestic use.  
Always wipe with a dry cloth, not use products containing solutions solvents or ammonia.

Avoid direct sunlight or exposition in humid environments.

The color and some characteristics of his own wood secure any type of alteration, this is natural for relocation natural climate.

Atualizado: 01/05/14

**m ó v e i s**  
**MPO**  
Qualidade em móveis, compromisso com você.

**MÓVEIS PRINCESA OESTE LTDA.**

BR-282 Km 582,5

CEP: 89870-000

Pinhalzinho-SC- Brasil

Fone/fax:+55(49) 3366-1911

www.moveimp.com.br

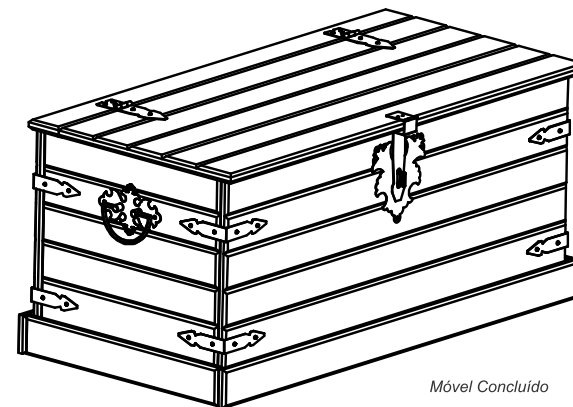

Móvel Concluído

## 8180/9180 - Bau Maciço

### BAUL DE MADEIRA MACIZA

### SOLID WOODEN TRUNK









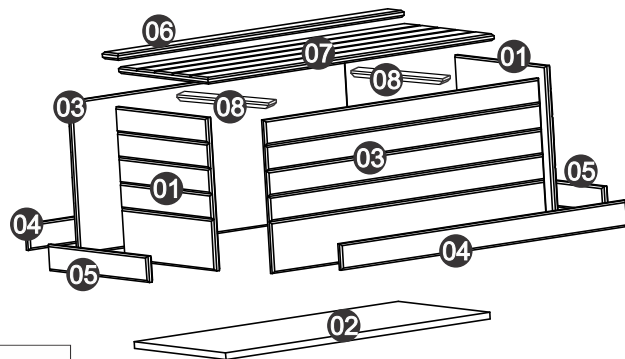

#### Observações/Observaciones/Observation

- \* Fixar toda a ferragem indireta antes de começar a montagem. (Dobrações nas portas, cavilhas nas travessas, etc. Sempre obs. o desenho).
- \* Fijar todas las piezas metálicas, antes de comenzar el montaje. (Tacos de madera en los laterales, vigas de madera, bisagras, etc. (Siempre mirando el dibujo paso a paso).
- \* Hinges in the doors, peg in the lates, etc. (Always watching the drawing)

#### Importante/Important

- \* Para um bom resultado na montagem dos produtos, siga as instruções como o indicado, respeitando passo a passo a sequência numérica na ordem crescente. Utilize a embalagem do produto para cobrir o chão para evitar riscos nas peças.
- \* Para un buen resultado en el montaje de los productos, seguir las instrucciones como indica el montaje paso a paso, siempre en orden creciente.
- \* For a good result in mounting products, follow the instructions, step by step the number sequence.

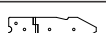

Código	Lista de Ferragens (Identifying the Hardware/Ferreteria Incluída)		
162-7	A		Parafuso 4,5 x 40 20
163-0	B		3,5 x 16 Black 55
162-4	C		Parafuso 3,5x30 10
162-0	D		Parafuso 3,5x12 12
331-1	E		Cantoneira 4 furos 03
120-0	F		Cavilha 8 x 30 20
331-4	G		Cantoneira externa Baú 08
474-0	H		Alça Baú 02
473-0	I		Medalhão Baú 01
131-5	J		Dobradiça Brasão Baú 01
131-4	K		Dobradiça Lança 02



Lista das peças/List parts/ Listas de las piezas

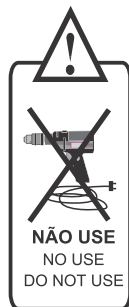

Nº	CÓD	DESCRIÇÃO	Descripción	Description	QTDE
1	193-31	LATERAL 410 X 410 X 18(BAU)	LADO	SIDE	2
2	173-31	BASE 866 X 410 X 18	BASE	BASE	1
3	193-32	LATERAL 904 X 410 X 18(FRENTE/TRAZ)	DELANTERO/TRASERO	FRONT/BACK	2
4	226-20	RODAPÉ 940 X 70 X 18	RODAPIÉ	BASEBOARD	2
5	226-21	RODAPE LATERAL 446 X 70 X 18	RODAPIÉ LATERAL	SIDE BASEBOARD	2
6	144-90	MONTANTE TAMPO 940 X 70 X 18	CANTIDAD SUP	TOP AMOUNT	1
7	229-23	TAMPO 940 X 400 X 18	SUPERIOR	TOP	1
8	146-49	TRAVESSA TAMPO 300 X 27 X 20	MESA SUPERIOR	TOP TABLE	2
9	183-64	KIT FERRAGEM 8180	KIT DE HERRAMIENTAS	TOOL KIT	1

