

MANUAL DE MONTAGEM

ATENÇÃO:

- 1 - Ler atentamente todo o manual antes de iniciar a montagem do móvel.
- 2 - A montagem deve ser feita em uma superfície plana e limpa.
- 3 - Recomenda-se utilizar a embalagem do móvel para forrar e chão e assim não danificá-los

LIMPEZA E CONSERVAÇÃO:

A limpeza do móvel deve ser feita com utilização de pano umedecido com água, podendo conter uma pequena quantidade de álcool. Não utilize produtos abrasivos.

GARANTIA:

90 dias para defeitos de fabricação.

Quantidade de pessoas
necessárias para montar o
móvel

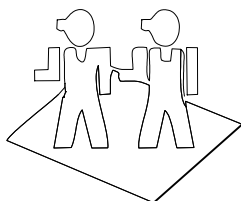







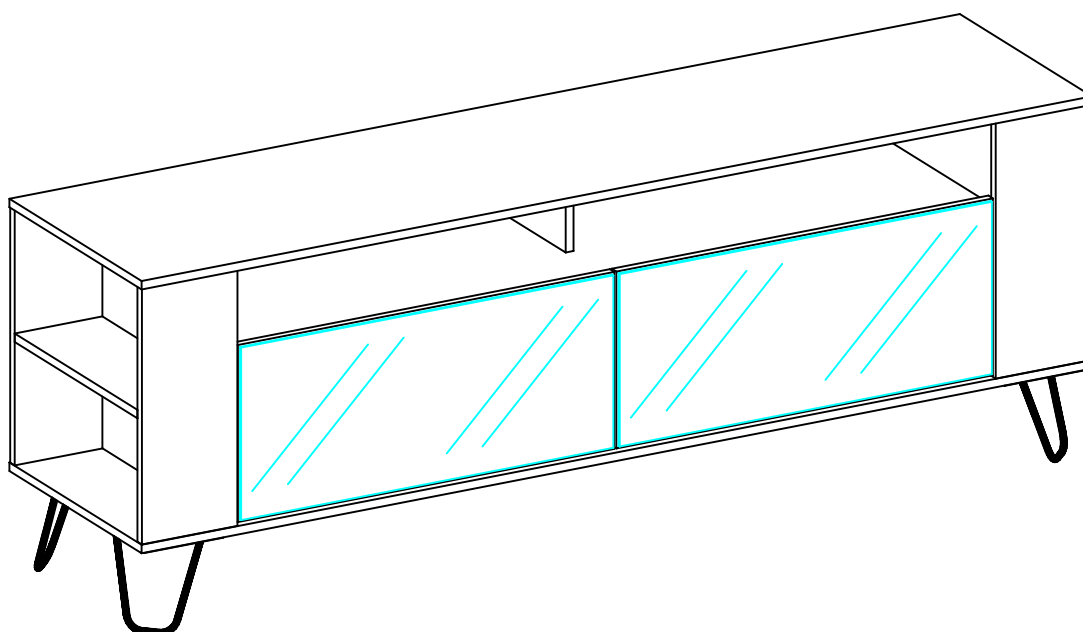
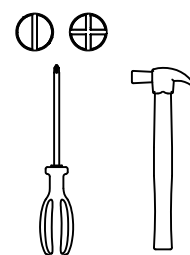

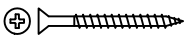
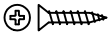

Tempo necessário para a
montagem: 4h

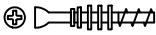
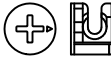
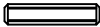















Ferramentas necessárias

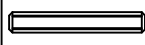
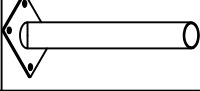

Lista de peças						
Código de assistência	Descrição	Quant.	Compr. (mm)	Larg. (mm)	Espes. (mm)	Caixa/ volume
01	Lateral direita	1	450	416	15	A
02	Lateral esquerda	1	450	416	15	A
03	Divisória	1	427	287	15	A
04	Prateleira externa	2	416	166	15	A
05	Apoio do tampo	1	288	148	15	A
06	Tampo	1	1800	448	15	A
07	Base	1	1800	448	15	A
08	Tampo das gavetas	1	1436	427	15	A
09	Lateral de gaveta direita	2	400	200	15	A
10	Lateral de gaveta esquerda	2	400	200	15	A
11	Cabeceira de gaveta	2	655	200	15	A
12	Costa das gavetas	1	470	470	3	A
13	Fundo de gaveta	2	668	398	3	A
14	Costa	4	450	181	15	A
15	Frente de gaveta direita	1	713	312	15	A
16	Frente de gaveta esquerda	1	713	312	15	A

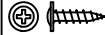
Ferragem			
	Código de assistência	Descrição	Quant.
A	226	 Parafuso chato 4,0x40 bicromatizado	20
B	5256	 Parafuso chato 4,0x20 bicromatizado	8
C	4214	 Parafuso chato 3,5x14 cabeça rebaixada	40
E	30945	 Minifix (parafuso)	16
F	30950	 Minifix (tambor)	16
G	1802	 Cavilha 6x30mm	52
H	107	 Pregão 10 x 10	38
I	18458	 Suporte triangular preto	8
J	38305	 Trilho telescópico mini light (35) 400mm	2
K	58	 Etiqueta marca "Kappesberg"	1
L	41	 Cola branca em bisnaga (10g)	1
M	43300	 Tapa furo adesivo branco fosco 19mm	16
M	43220	 Tapa furo adesivo pine 19mm	16

N	40483	 Tapa furo adesivo branco fosco 13mm	20
N	43293	 Tapa furo adesivo pine 13mm	20
O	27581	 Sapata para arame 10mm preto	4
O	41476	 Sapata para arame 10mm rose	4
P	43121	 Conjunto 4 pés de canto 171mm cinza	1
P	43123	 Conjunto 4 pés de canto 171mm rose	1
P	43122	 Conjunto 4 pés de canto 171mm verde	1
P	43493	 Conjunto 4 pés de canto 171mm branco	1
Q	1925	 Cavilha 6x50mm	2
R	43447	 Pé central regulável Branco fosco	1
S	43813	 Bucha 7/8 preta c/rosca	1
T	43154	 Espelho 70,5x30,4 (4mm)	2
U	8578	 "L" de zamaq	8
V	1178	 Parafuso flange 3,5x16 bicromatizado	16
Z	43814	 Pé nivelador sext. 5/16x7/8 preto	1



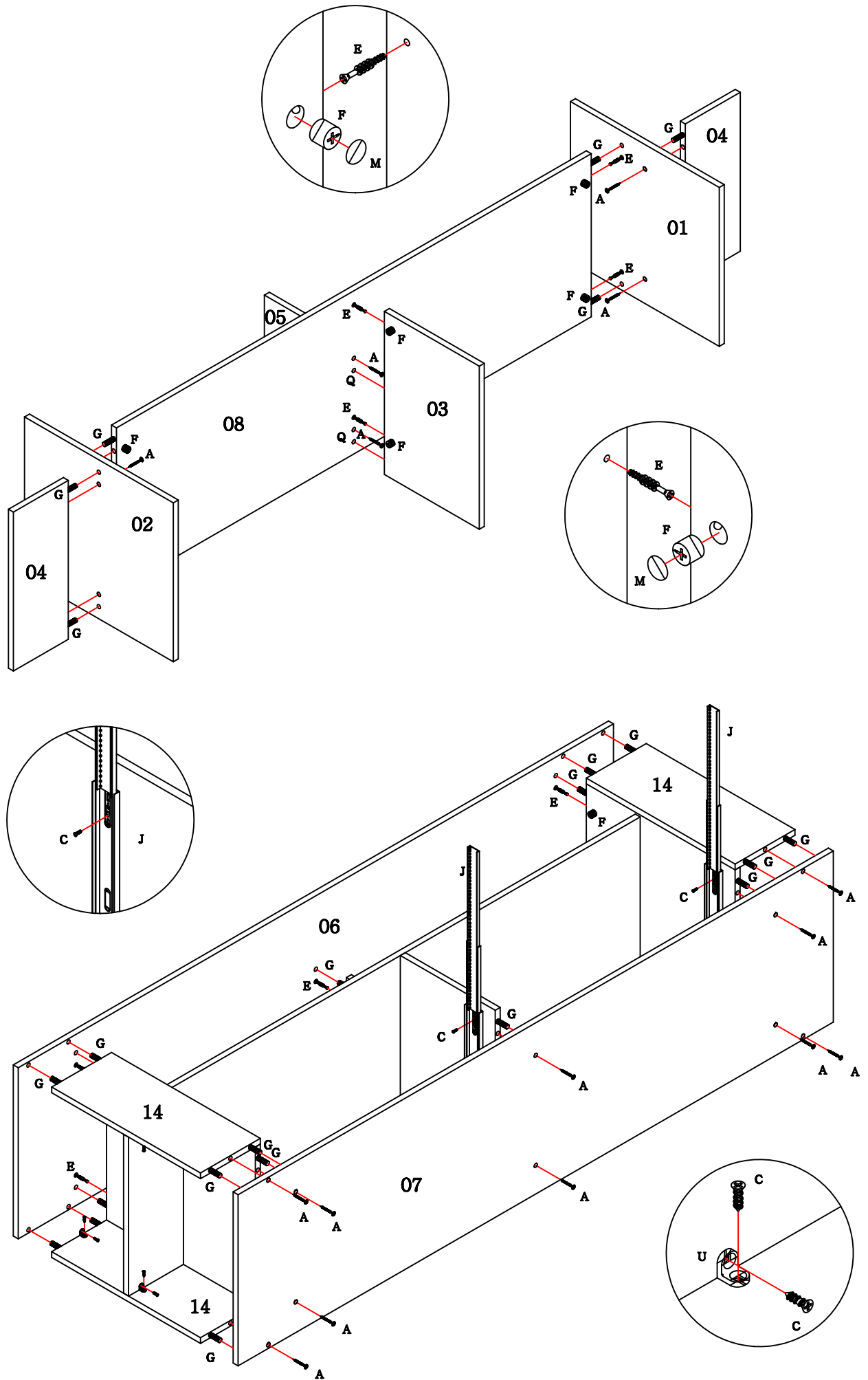

Para colocar a sapata no pé, coloque a sapata sobre uma superfície plana e pressione o pé contra ela

