

ME - 4190

Instruções de Montagem Assembly Instructions Instrucciones de Montaje

Acesse Vídeos de Montagens
Access Mounting Videos
Acceder a los Vídeos de Montaje
www.tecnomobili.ind.br

tecnomobili

Estrada RSC 453, Km s/n° | Garibaldi | RS
CEP: 95720-000 | Fone / Fax: 54.3464.2050
sac@moveisvideira.com.br

Notas Especiais:

01 -Examine completamente todas as peças do móvel antes de começar o trabalho.

02 -Recomenda-se montar o móvel conforme este Manual de Montagem.

03 -É de responsabilidade do montador seguir as instruções do Manual de Montagem, que são fundamentais para garantir a estrutura do móvel.

04 -Para limpeza, utilizar somente pano úmido e sabão neutro.

Special notes:

01 -Check all parts of the unit thoroughly before starting work.

02 -It is recommended to assemble the furniture according to this Installation Manual.

03 -It is the responsibility of the assembler to follow the instructions in the Assembly Manual, which are essential to ensure the structure of the furniture.

04 -For cleaning use only damp cloth and neutral soap.

Notas especiales:

01 -Examine completamente todas las piezas del mueble antes de iniciar el trabajo.

02 -Se recomienda montar el mueble conforme el Manual de Ensamblaje.

03 -Es de responsabilidad del montador seguir las instrucciones del Manual de Ensamblaje, que son fundamentales para garantizar la estructura del mueble.

04 -Para limpieza solamente usar trapo húmedo y jabón neutro.

Guarante certificate:

The guarantee of products manufactured by Móveis Videira LTDA covers any defects / manufacturing defects, within the period established by the Consumer Protection Code, in its Article 26, II, which provides for a legal guarantee of ninety (90) days.

Ferramentas | Tools | Herramientas

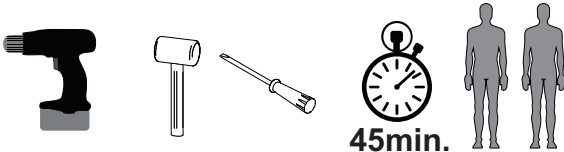



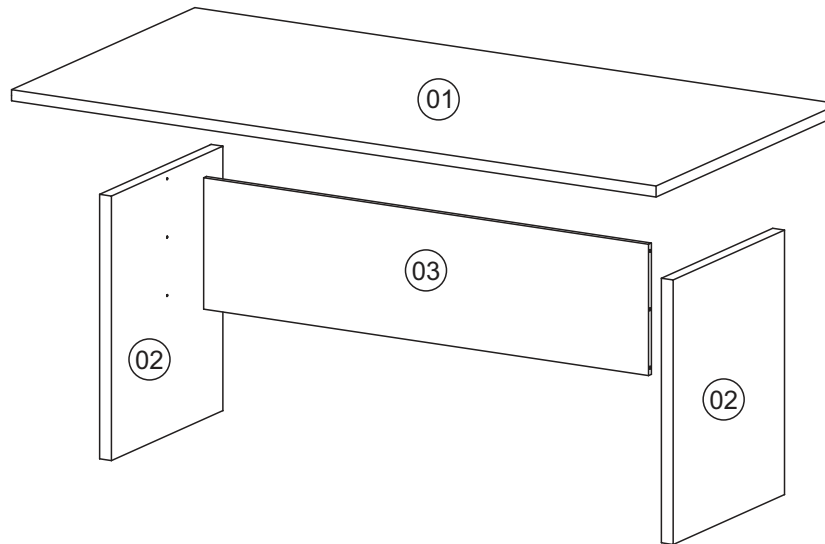

Lista de Peças / List of pieces / Lista de piezas

CÓD	DESCRIÇÃO	DESCRIPTION	DESCRIPCION	QTD	M. PRIMA	DIMENSÕES	CÓD
01	Tampo	Top	Tapa	1	MDP 15mm	2200x1000x30	714190
02	Lateral	Side	Lateral	2	MDP 25mm	725x590x25	304119
03	Divisão	Division	División	1	MDP 15mm	1500x338x15	504190

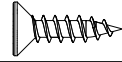

REF DESCRIPTION QTDCOD

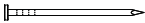
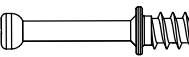
A	 Adesivo Tapa Furo	06	
B	 12 x 12 x 12mm Cantoneira 2 Furos	12	3615
C	 Parafuso 3,5 x 14mm CC	24	3639
D	 15 x 12mm Tambor Minifix	06	9516
E	 14 x 4mm Sapata Deslizadora	04	8112
F	 22 x 3mm Prego 10 x 10	04	3051
G	 34 x 7mm Parafuso Minifix	06	3771

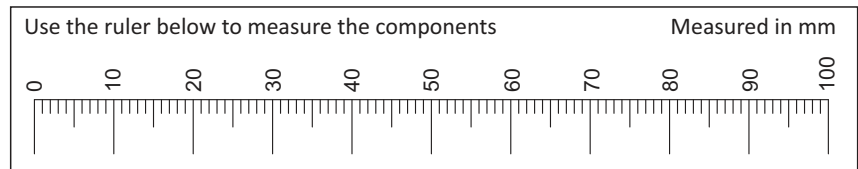

Review: 00
Date: 17/02/2025

Agora que você já comprou o seu móvel, ele merece ser montado do jeito certo.

Erros de montagem causam mais de **60%** dos danos em móveis.

Por que contratar?

Tranquilidade do **início ao fim** da montagem



PROFISSIONAIS QUALIFICADOS

Especialistas certificados na **MadeiraMadeira Serviços**.



FERRAMENTAS PROFISSIONAIS

que **protegem** seus móveis.



AGENDAMENTO EM 24 HORAS

escolha a data e o turno **ideais para** você.



GARANTIA DE 3 MESES

de cobertura **completa**.

Mais de 1 MILHÃO DE MONTAGENS
★ com avaliação **4.7** ★

Mariana S., São Paulo

"Chegaram no horário e montaram tudo rapidamente. Serviço incrível!"



Carlos R., Belo Horizonte

"Tentei montar sozinho e foi um desastre. Com a **MadeiraMadeira Serviços** ficou perfeito."



Ana P., Rio de Janeiro

"Agendamento ágil e **montagem pontual e perfeita**. Recomendo demais!"



Agende agora pelo
QR Code



Madeira**Madeira** Serviços · Atendimento em todo o Brasil

Escaneie o QRCode