

BE4080

Instruções de Montagem

www.artinmoveis.com.brART  MÓVEIS

Soluções Criativas para o seu lar

Rua Joni José Bozzeto, 300 - Bairro Tamandaré
Garibaldi | RS | CEP: 95720-000 | Fone / Fax: 54.3464.7071

CAMA ARTICULÁVEL DE PAREDE SANTIAGO

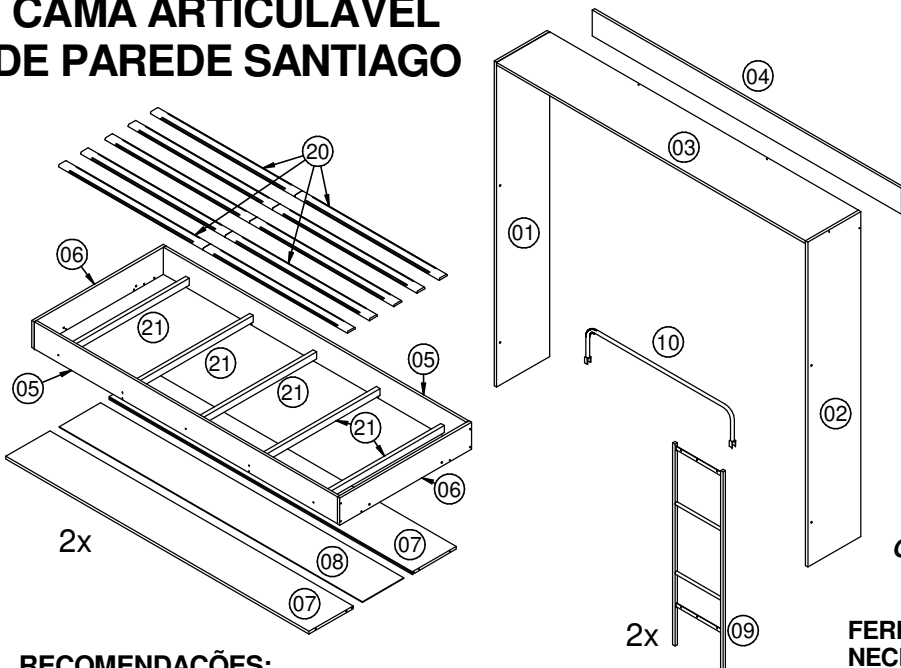

Lista de peças			
COD	DESCRIÇÃO	DIMENSÃO	QTD
01	Lateral Esquerda	1754x330x15	1
02	Lateral Direita	1754x330x15	1
03	Tampo	1926x330x15	1
04	Costa	1926x140x15	1
05	Barra	1890x146x15	4
06	Cabeceira	821x146x15	4
07	Lastro Cama	1890x238x15	4
08	Costa Fundo	1890x330x03	2
09	Escada	1090x315x15	2
10	Protetor	920x200x17	1
20	Lastrinho 900	900x50x10	20
21	Suporte de Lastro 790	790x37x22	10

OBS: Espessura máxima do colchão deve ser de 16cm.

RECOMENDAÇÕES:

- 01** - Examine completamente todas as peças do móvel antes de iniciar o trabalho.
- 02** - Recomenda-se montar o móvel conforme este Manual de Montagem.
- 03** - É de responsabilidade do montador seguir as instruções do Manual de Montagem, que são fundamentais para garantir a estrutura do móvel.
- 04** - Certifique-se de que todos os acessórios utilizados na montagem (parafusos, porcas, ponteiras) estejam fixados o suficiente, totalmente atarraxados, evitando que venham a provocar ferimentos.

LIMPEZA:

- 01** - Pano levemente umedecido com água, seguido de pano seco.
- 02** - Não utilizar produtos químicos ou abrasivos.

GARANTIA:

- 01** - 3 meses para defeitos ou vícios de origem.

FERRAMENTAS NECESSÁRIAS:

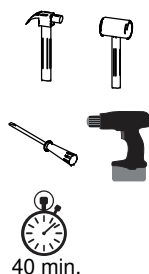



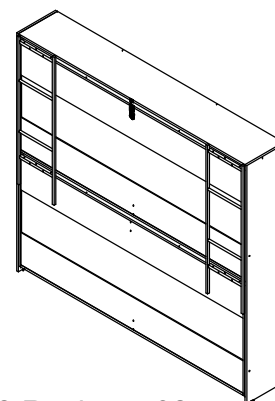









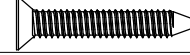
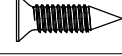
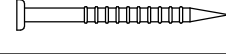
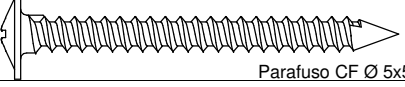
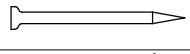

40 min.

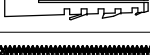

Data: 12/03/2018 Revisão: 02

ADVERTÊNCIAS:

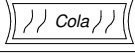
- 01** - Esteja ciente do risco de chama aberta e outras fontes de calor, tais como aquecedores elétricos, aquecedores a gás etc. nas proximidades do produto.
- 02** - Não utilize o produto se alguma parte estiver quebrada, rasgada ou faltando. Utilizar somente peças de reposição aprovadas pelo fabricante.

REF	DESCRIÇÃO	QTD
A	 Cavilha Ø 6x30	40
B	 Parafuso CC Ø 3,5x40	38
C	 Parafuso CC Ø 3,5x25	22
D	 Parafuso CC Ø 3,5x14	08
E	 Prego Anelado 12x12	60
F	 Parafuso CF Ø 5x50	24
G	 Prego C/ Cabeça 10x10	04
H	 Trava	01
I	 Sapata Deslizadora	04
J	 Etiqueta adesiva Art in móveis. Colocar no lado externo do produto	01
K	 Suporte Fixação Aéreo	02
L	 Proteção P/ Suporte Cantoneira	02
M	 Buchta Plástica Ø8mm	04
N	 Parafuso M8 x 60mm	04
O	 Arruela M8	04
P	 Arruela M8	04
Q	 Porca M8	08
R	 Cola	01
S	 Adesivo tapa furo	16

"IMPORTANTE LER COM ATENÇÃO E GUARDAR PARA EVENTUAIS CONSULTAS"

1 Utilizar cola (P) nas cavilhas.

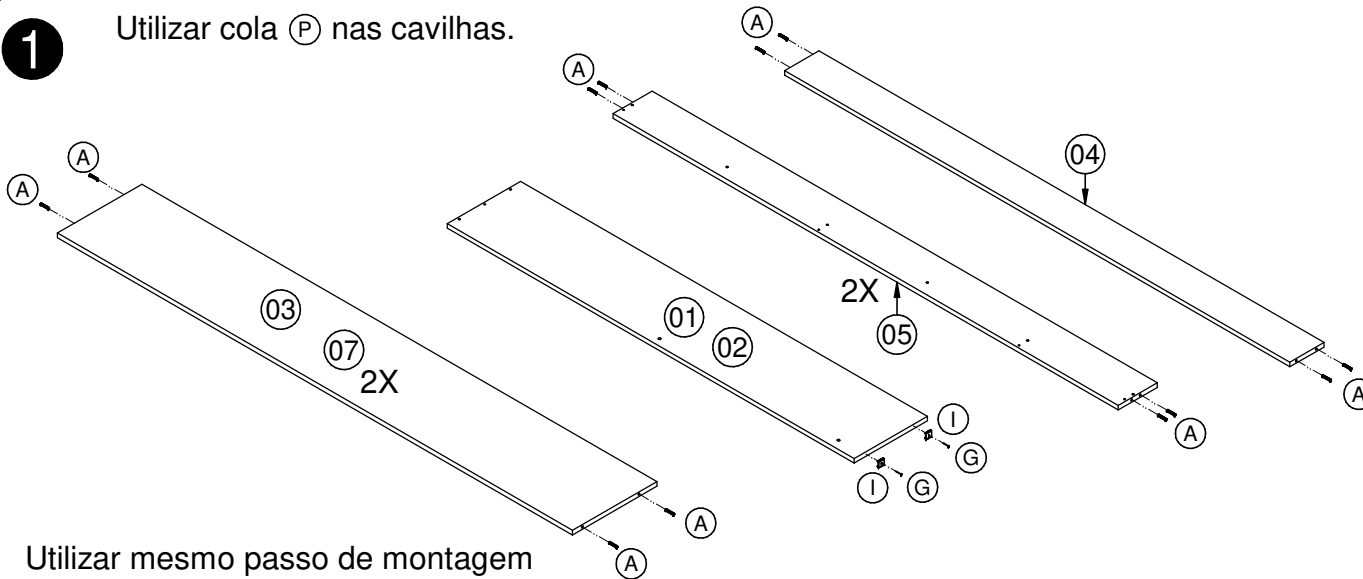

Utilizar mesmo passo de montagem para as peças "03" e "07".

2 2X

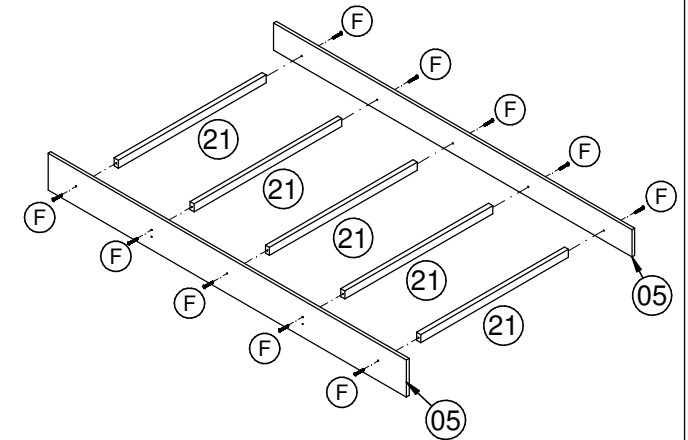

3 2X

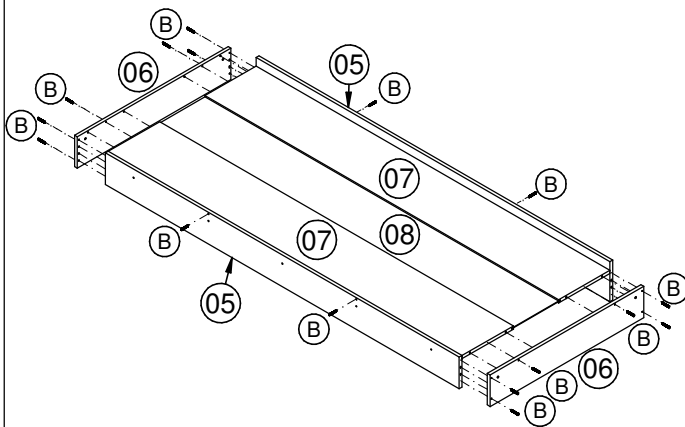

Encaixar a costa "08" na ranhura dos lastros "07".

4 Fixar lastros utilizando pregos "E".

2X

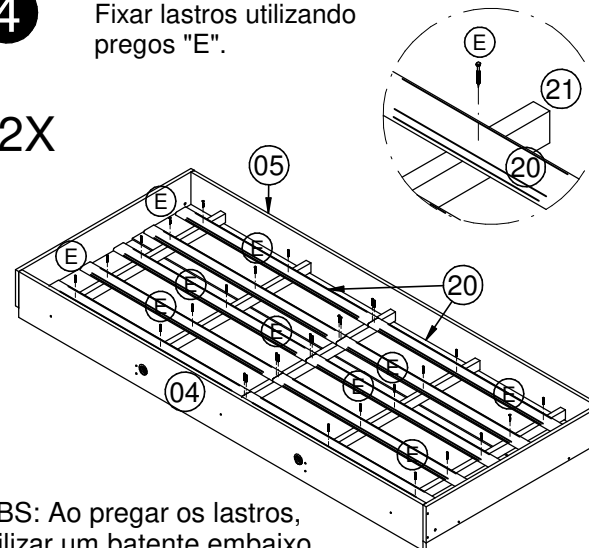

OBS: Ao pregar os lastros, utilizar um batente embaixo para dar maior resistência.

5

