



Rua: 26 de Dezembro, 326
Centro - CEP: 15155-000 - Jaci-SP
Fones: (17) 3283-1393 / 3283-1394 / 3283-1366
Fax: (17) 3283-1317
ejmoveis@ejmoveis.com.br
www.ejmoveis.com.br

INSTRUÇÃO DE MONTAGEM



Armário para Bebedouro Aquarius

DESEMBALANDO

Identifique todas as peças e deixe-as de pé, nunca coloque umas sobre as outras.
Utilize a própria embalagem como tapete para a montagem do produto.

PARA A LIMPEZA E CONSERVAÇÃO DO SEU MÓVEL













X Não use produto abrasivo como álcool, solventes, acetonas e etc...

✓ Use somente um pano macio e seco.

LISTA DE PEÇAS

Ref.		Descrição de Peças	Medida Pçs
01	01	Base	420x380x12
02	01	Lateral Esquerda	685x350x12
03	01	Lateral Direita	685x350x12
04	01	Tampo	420x380x12
05	01	Fundo Traseiro	705x375x2,8
06	01	Frente Gaveta	370x160x12
07	02	Lateral Gaveta	345x130x12
08	01	Fundo Gaveta	345x325x2,8
09	01	Contra Fundo Gaveta	312x100x12
10	01	Porta	

LISTA DE ACESSÓRIOS

Cód.	Acessórios	Qtd.	Cód.	Acessórios	Qtd.
A	Cavilha 6x30 	12	G	Puxador 	02
B	Parafuso 3,0x12 	48	H	Cantoneira 	08
C	Parafuso 3,5x25 	02	I	Dobradiça 	02
D	Sache de cola PVA 	01	J	Paraf. 5,0x40 	02
E	Corrediça 	01 Par	K	Prego 12x12 	04
F	Prego 8x8 	20	L	Rodízios 	04

Passo 01

Atenção Sr. Montador: Antes da montagem do móvel, favor conferir os códigos dos acessórios na lista de acessórios.

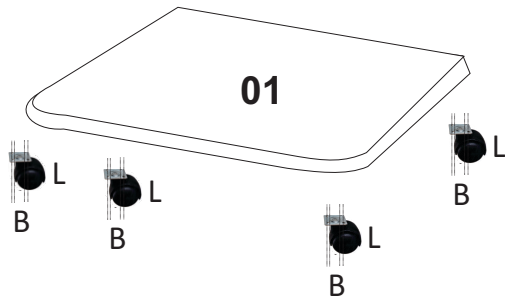

Passo 02

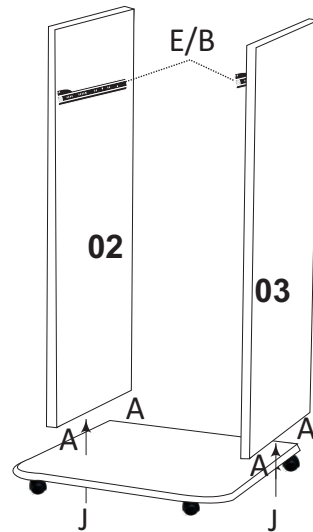

Passo 03

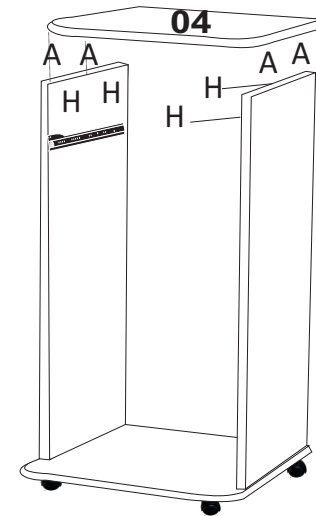

Passo 04 / Pregar Fundos e fixar a porta.

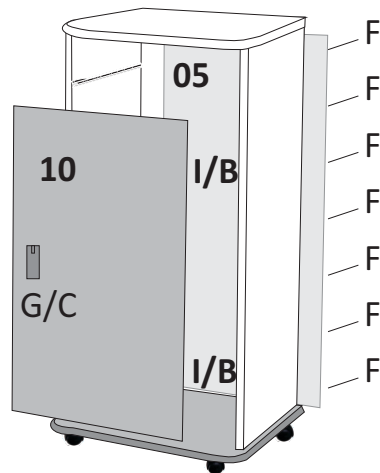

Passo 05 / Montar Gaveta

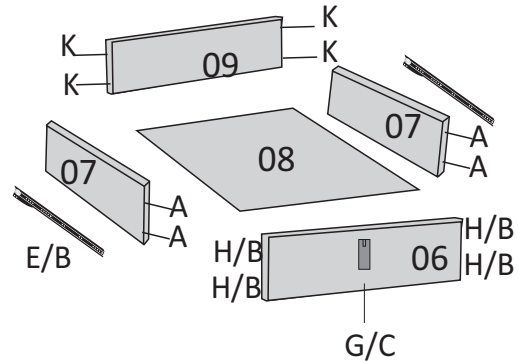

Móvel Pronto

