





LISTA DE PEÇAS DO LIVREIRO OFFICE











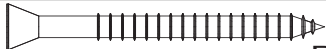

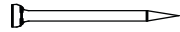

Nº	Cód.	Descrição de Peças	QTD.
01	-	Lateral Esquerda	01
02	-	Prateleira Fixa Maior	01
03	-	Prateleira Fixa Menor	01
04	-	Lateral Direita	01
05	-	Base	01
06	-	Chapéu	01
07	-	Fundo (1825 x 295 x 03)	02
08	-	Prateleira Interna da Porta	01
09	-	Prateleira Móvel	02

LISTA DE PEÇAS, PORTAS OPCIONAIS

10	-	Porta Pequena	02
11	-	Porta Grande	02

Acessório das portas opcionais (Grande)			
J		Parafuso 4,0 x 25	04
K		Parafuso 3,5 x 12	24
L		Puxador	02
M		Dobradiça 26mm	06
N		Calço Dobradiça	06

Livreiro Office SS

	DESCRIÇÃO	QTD
A	 Parafuso 3,5 x 40	12
B	 Cavilha 06 x 30	08
C	 Pregos 08 x 08	50
D	 Parafuso 4,0 x 30	04
E	 Etiqueta	01
F	 Pino Prateleira	12
G	 Perfil H	01
H	 Giz de Correção	01
I	 Pé Quadrado	04
Acessório das portas opcionais (Pequena)		
J	 Parafuso 4,0 x 25	04
K	 Parafuso 3,5 x 12	16
L	 Puxador	02
M	 Dobradiça 26mm	04
N	 Calço Dobradiça	04

DESEMBALANDO

Identifique todas as peças e deixe-as de pé, nunca coloque umas sobre as outras. Utilize a própria embalagem como tapete para a montagem do produto.

PARA A LIMPEZA E CONSERVAÇÃO DO SEU MÓVEL



Não use produtos abrasivos como Álcool, Solventes, Acetona e etc...

Use somente um pano macio e seco.

Passo 01

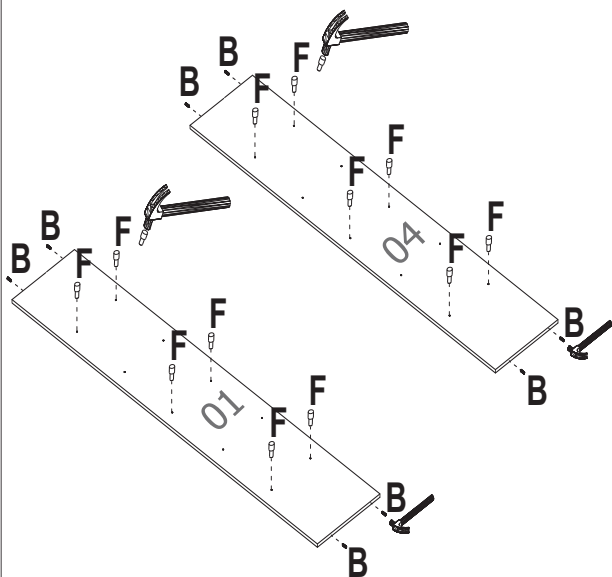
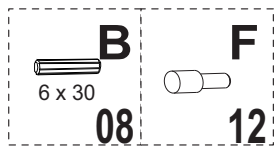

Passo 02

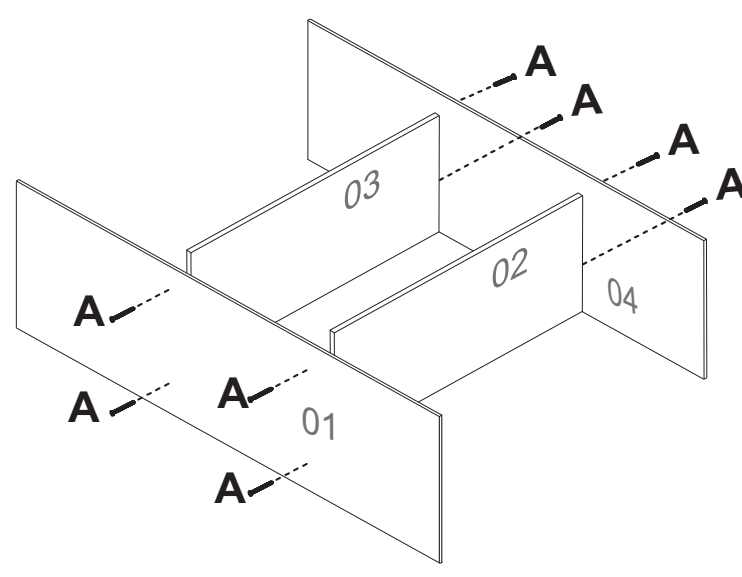
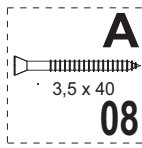

Passo 03

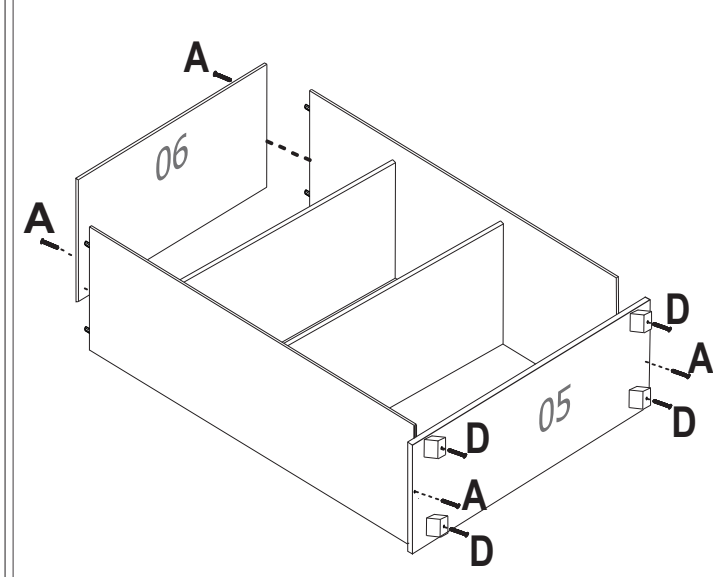
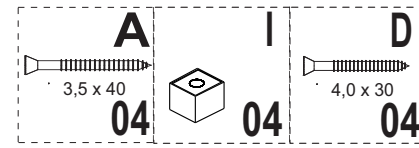

Passo 04

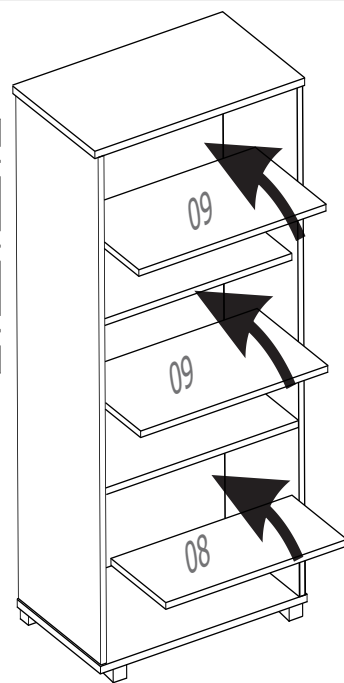
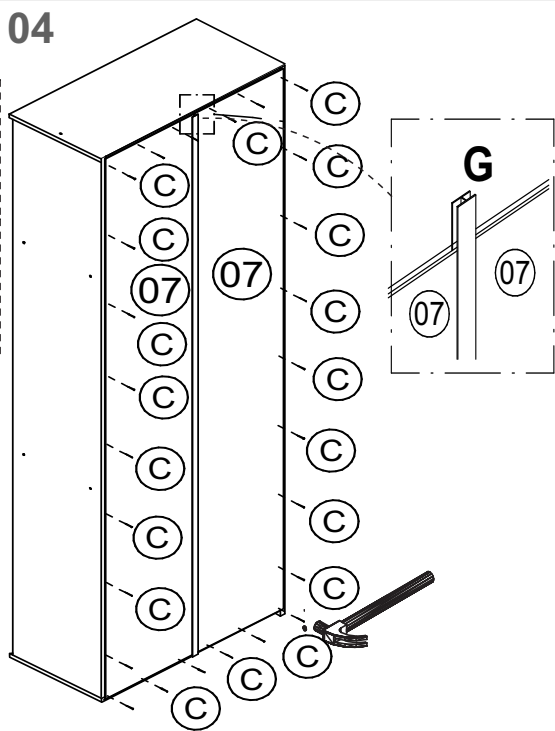
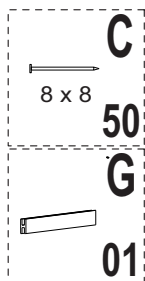

Passo 05 Portas Opcionais

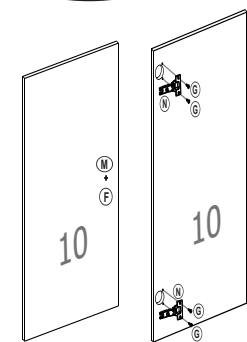
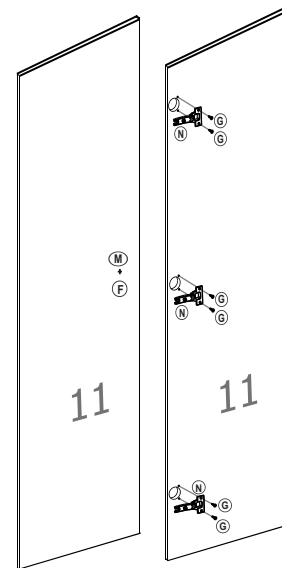

Amigo montador nesse produto damos a opção de vc monta-lo tanto aberto , com 2 portas menores e 2 portas maiores q são vendidas separadamente