

# CAVAZOTTO

Rua Florianópolis, 570 - Centro - Coronel Freitas - SC - Brasil - CEP: 89840-000  
Telefone: +55 (49) 3347-0207 - cavazotto@cavazotto.com.br

## MANUAL DE MONTAGEM

### ROUPEIRO 6 PORTAS

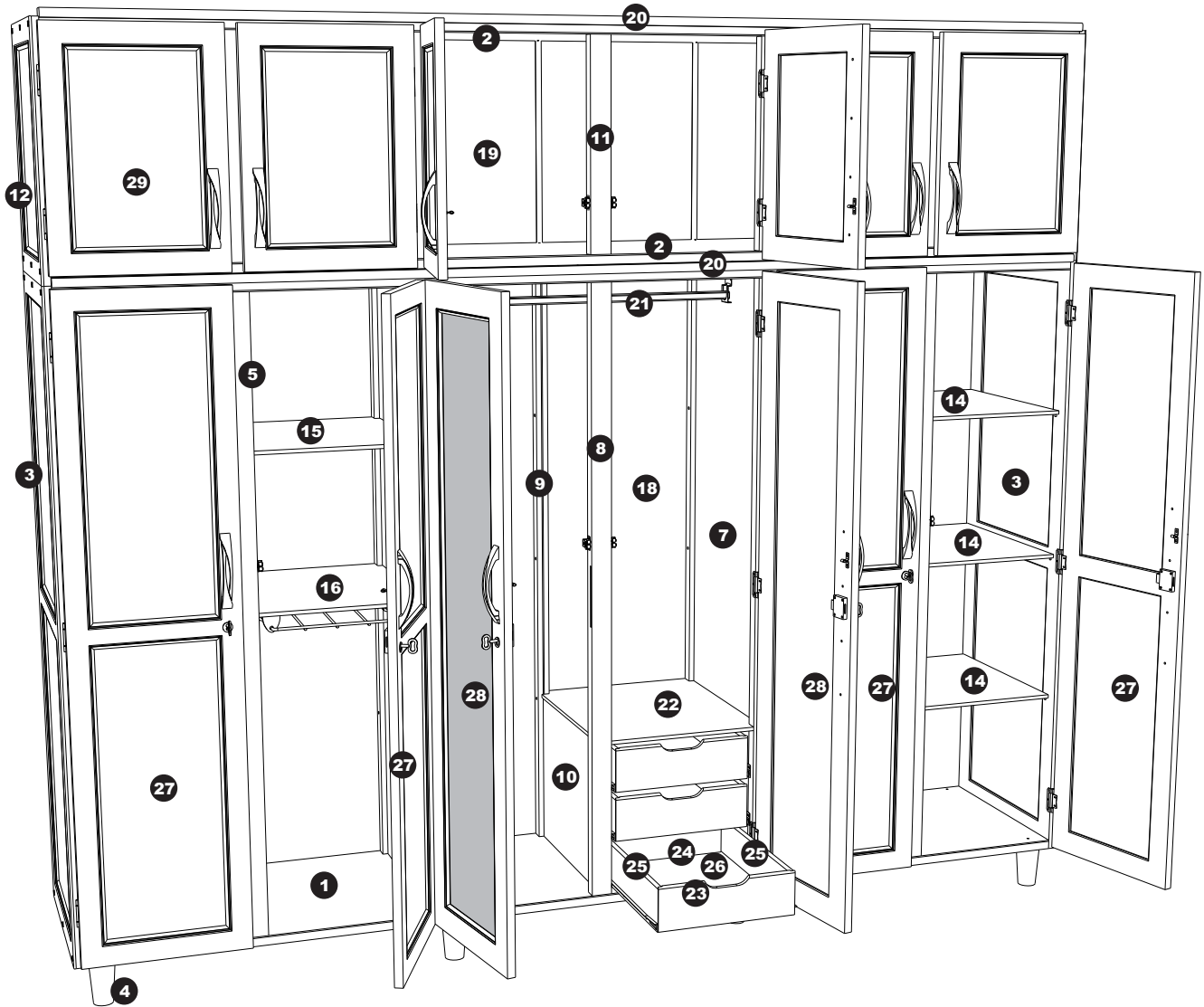

#### COMPONENTES

- |  |  |   |
|--|--|---|
| 1 - Base inferior (2500x500x23mm)                            | 12 - Lateral esquerda do maleiro (500x565x20mm)    | 24 - Travessa traseira da gaveta (x3) (325x95x11mm)     |
| 2 - Base (x3) (2500x500x23mm)                                | 13 - Lateral direita do maleiro (500x565x20mm)     | 25 - Travessa lateral da gaveta (x6) (450x110x11mm)     |
| 3 - Lateral do roupeiro (x2) (500x1545x20mm)                 | 14 - Prateleira menor (x6) (465x400x9mm)           | 26 - Fundo da gaveta (x3) (335x450x3mm)                 |
| 4 - Pés (x8) (50x50x90mm)                                    | 15 - Prateleira maior (x2) (465x420x9mm)           | 27 - Porta do roupeiro (x4) (390x1535x20mm)             |
| 5 - Divisória central da porta completa (x2) (500x1500x50mm) | 16 - Prateleira calceiro (x2) (465x420x9mm)        | 28 - Porta do roupeiro com espelho (390x1535x20mm) (x2) |
| 6 - Divisória da porta completa (500x1500x50mm)              | 18 - Fundo do roupeiro (x6) (420x1545x3mm)         | 29 - Porta esquerda do maleiro (x6) (390x535x20mm)      |
| 7 - Divisória direita do gaveteiro completa (500x1500x50mm)  | 19 - Fundo do maleiro (x6) (420x545x3mm)           | 30 - Apoio do maleiro (x2) (100x30x15mm)                |
| 8 - Coluna frontal (50x1500x30mm)                            | 20 - Moldura (x2) (2500x45x20mm)                   |   |
| 9 - Coluna traseira (30x1500x30mm)                           | 21 - Cabideiro (840x20x20mm)                       |   |
| 10 - Divisória esquerda do gaveteiro (460x380x3mm)           | 22 - Tampo do gaveteiro (500x425x9mm)              |   |
| 11 - Coluna do maleiro (x5) (50x500x30mm)                    | 23 - Travessa frontal da gaveta (x3) (325x95x11mm) |   |

## FERRAMENTAS NECESSÁRIAS

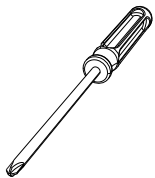

Chave philips

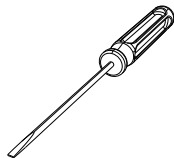

Chave de fenda

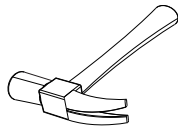

Martelo

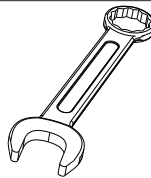

Chave de boca nº6

## FERRAGENS

**A**

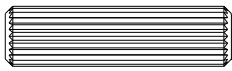

Cavilha 8x30 (x20)

**B**

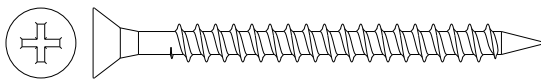

Parafuso philips 5,0x60mm (x8)

**C**

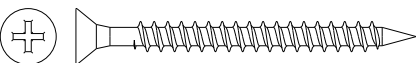

Parafuso philips 4,0x45mm (x54)

**D**



Tapa-furo  
10mm (x24)

**E**

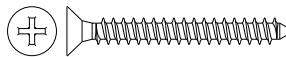

Parafuso philips 4x30mm (x51)

**F**



Parafuso philips  
3,5x16mm cabeça  
panela (x168)

**G**

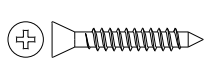

Parafuso philips  
3,5x20mm (x24)

**H**

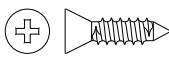

Parafuso philips  
3,5x14mm (x24)

**I**

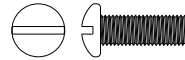

Parafuso fenda  
5/32x5/16 cabeça  
panela (x4)

**J**



Porca nº6  
(x4)

**K**

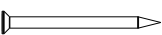

Prego 10x10 (x212)

**L**



Suporte para  
prateleira (x44)

**M**

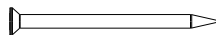

Prego 12x12 (x36)

**N**



Cantoneira  
(x4)

**O**

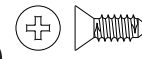

Parafuso philips  
3,5x10mm (x8)

## ACESSÓRIOS

**P**

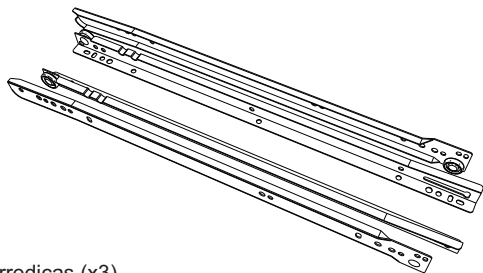

Par de correções (x3)

**Q**

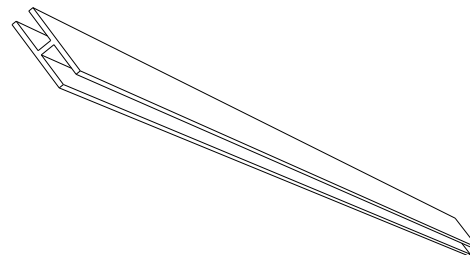

Perfil 545mm para fundo do maleiro (x5)

**R**

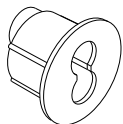

Guia para chave (x6)

**S**

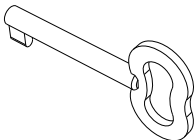

Chave (x6)

**T**

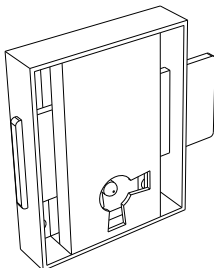

Fechadura (x6)

**U**

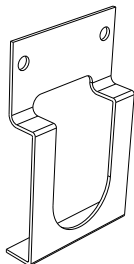

Suporte para  
cabideiro (x2)

**V**

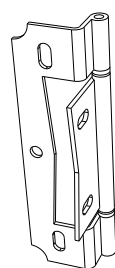

Dobradiça (x30)

**W**

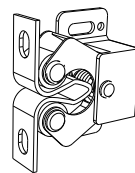

Fecho rolete (x12)

**X**



Puxador (x12)

**01**

**I** A base inferior possui mais furos do que as outras para a fixação dos pés.

**I** A divisória direita do gaveteiro completa (6) possui uma ripa acoplada.

**I** A divisória central da porta completa (5) possui fendas em sua coluna para a utilização da fechadura.

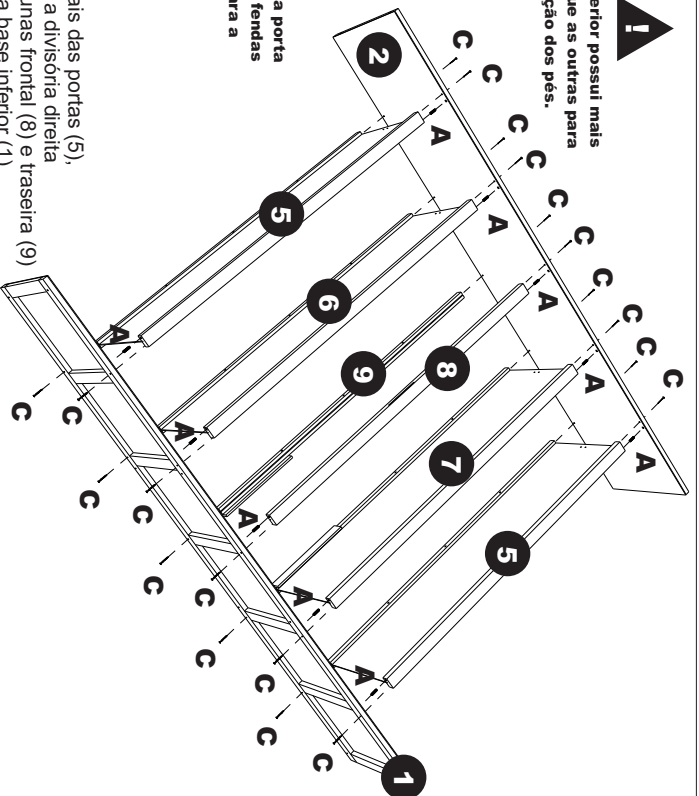

Fixe as divisórias centrais das portas (5), a divisória da porta (6), a divisória direita do gaveteiro (7), as colunas frontal (8) e traseira (9) na basesuperior (2) e na base inferior (1).

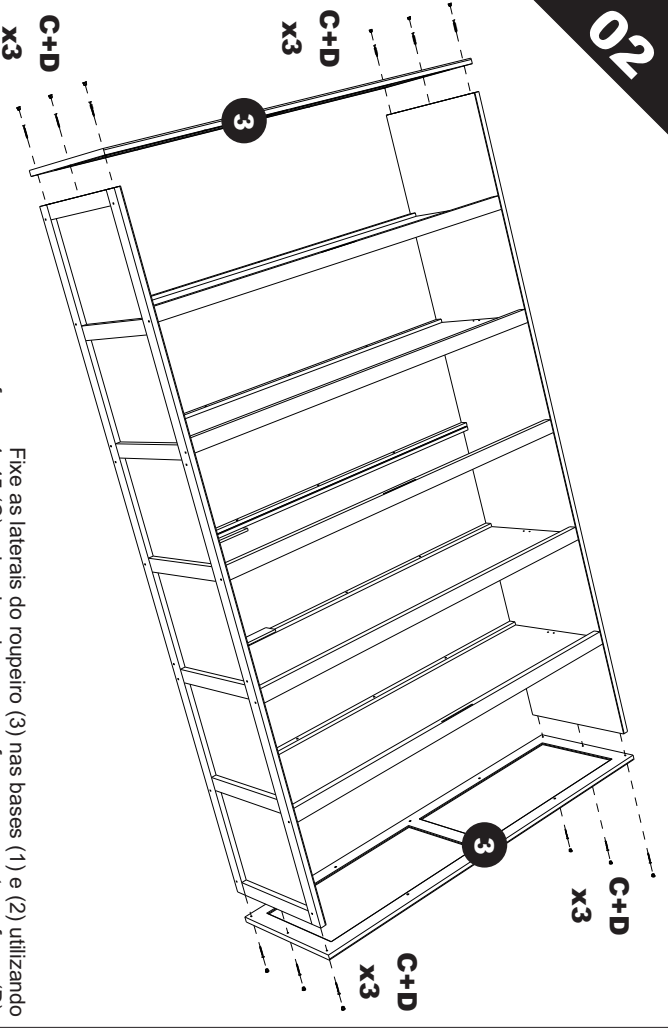
**02**

Fixe as laterais do roupeiro (3) nas bases (1) e (2) utilizando os parafusos 4x45 (C) e depois cubra os parafusos com os tapa-furos (D).

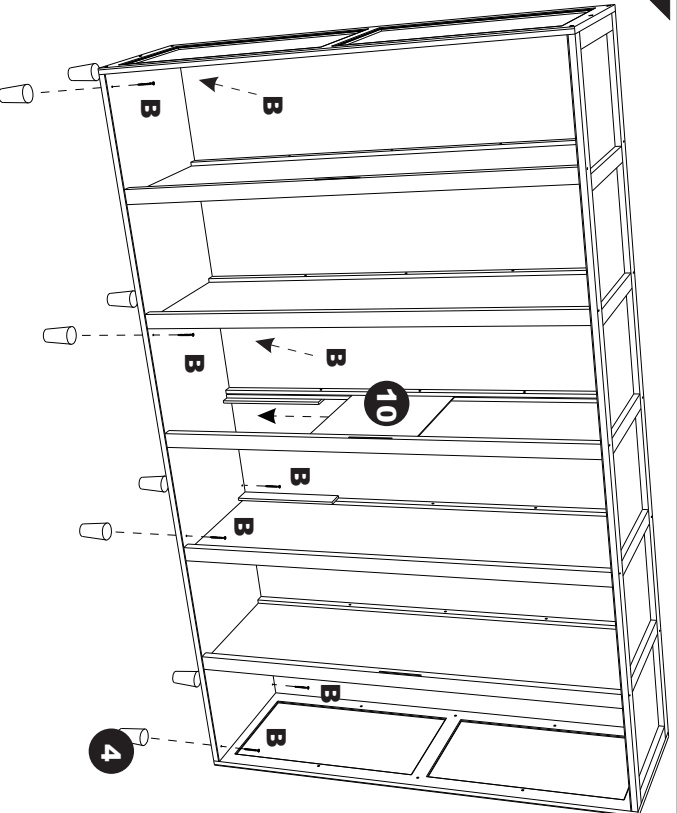
**03**

Insira a divisória esquerda do gaveteiro (10) e fixe os pés do roupeiro (4) na base inferior (1).

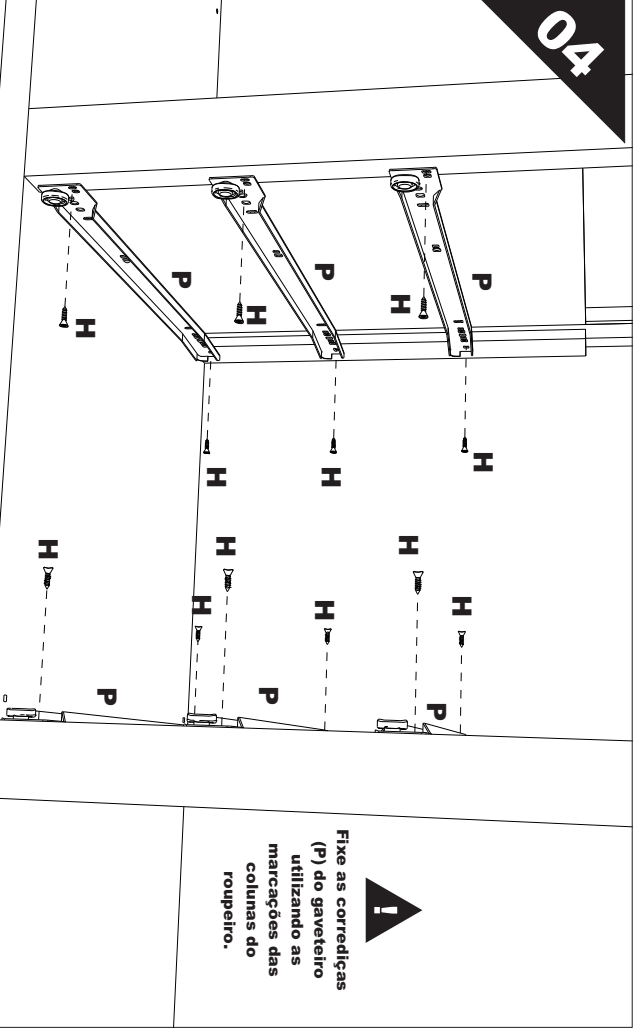
**04**

**I** Fixe as corredeiras (P) do gaveteiro utilizando as marcações das colunas do roupeiro.

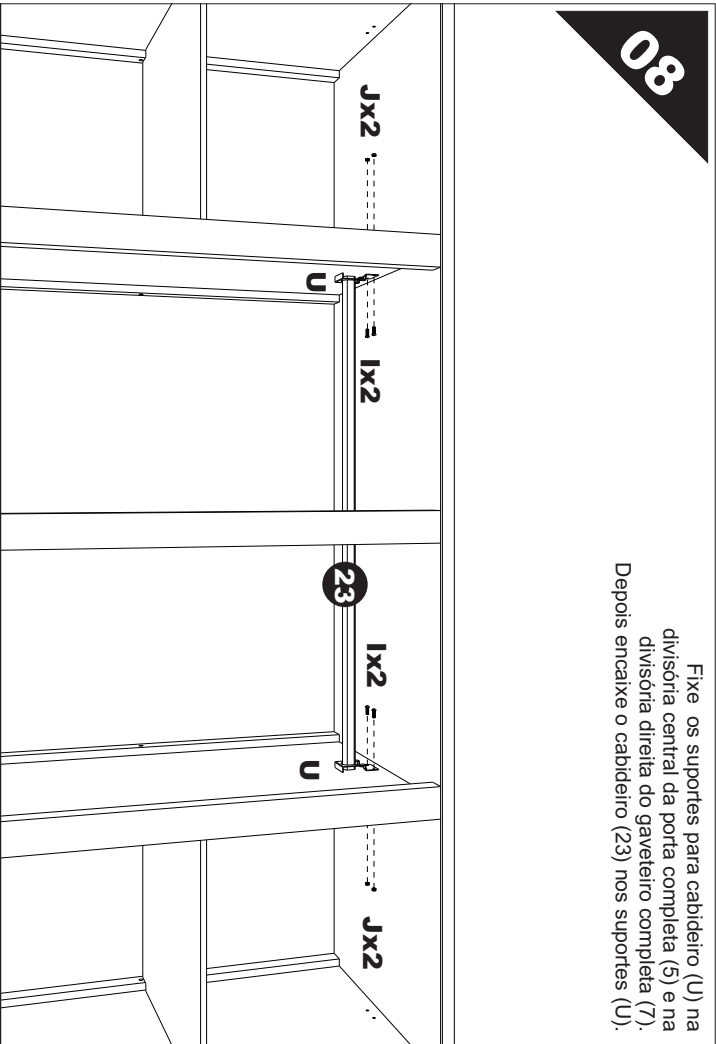
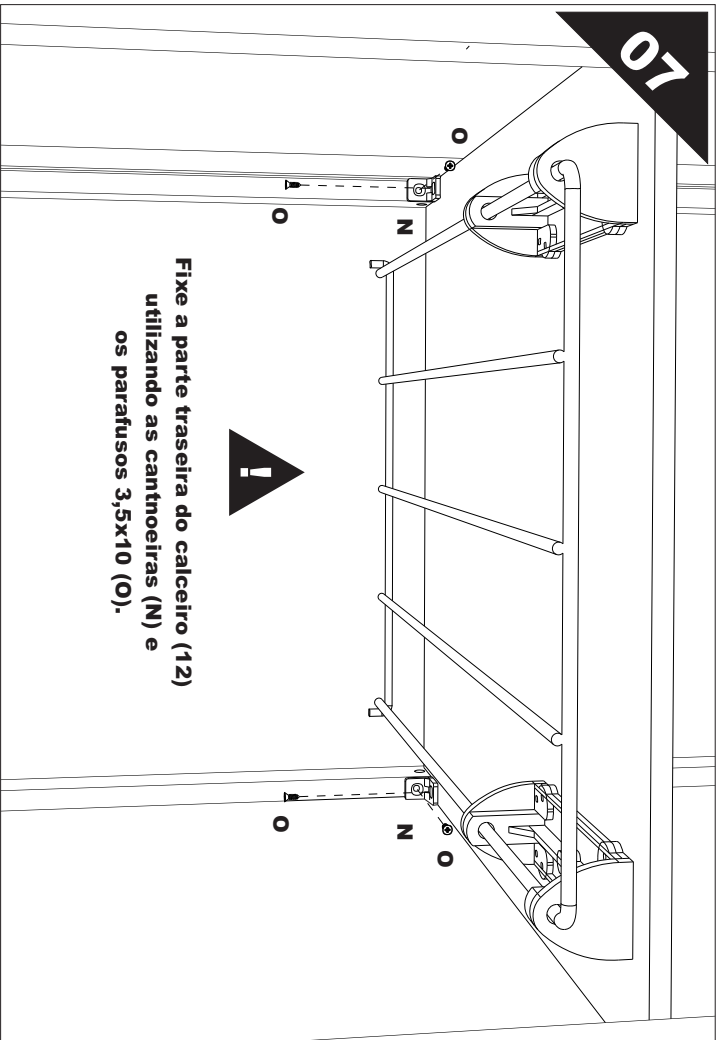
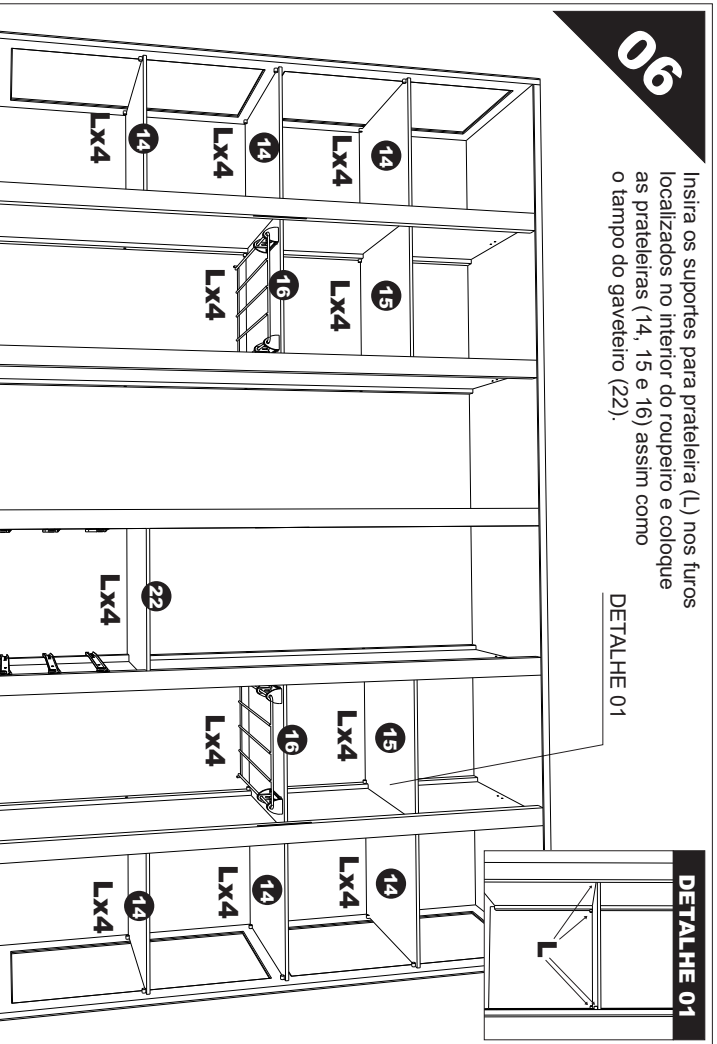
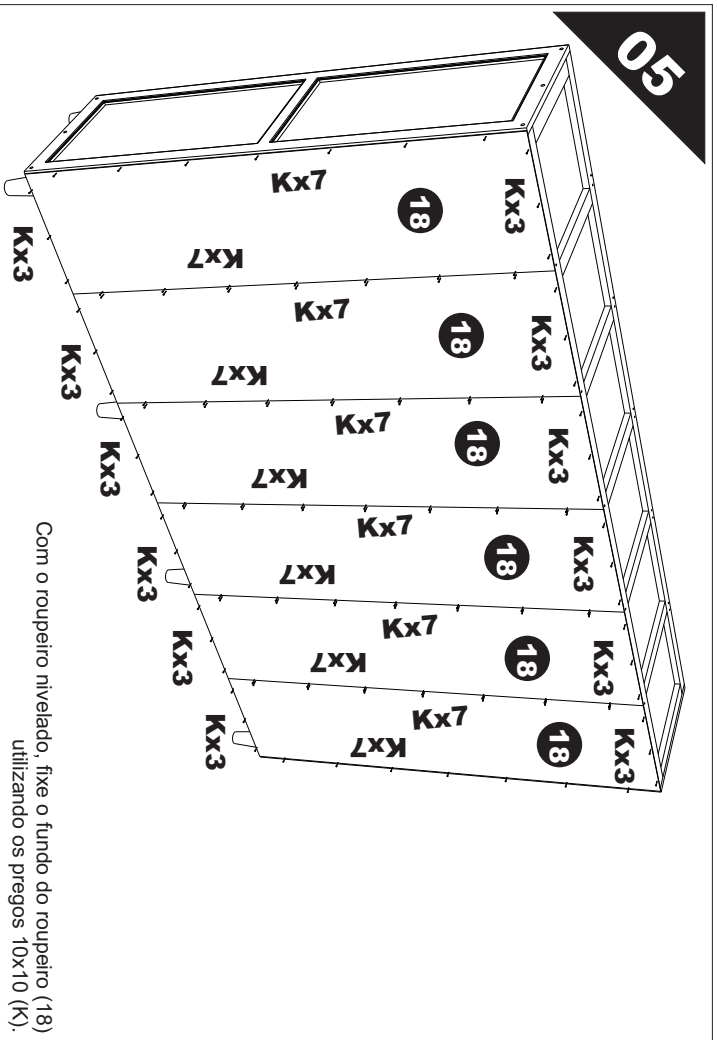

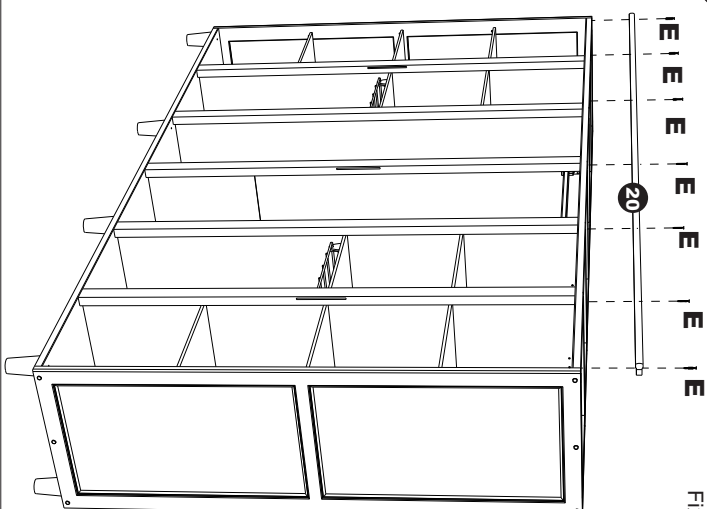
**09**

Fixe a moldura (20) no topo do roupeiro.

**10**

**A parte menor da dobradiça deve ser presa à porta.**

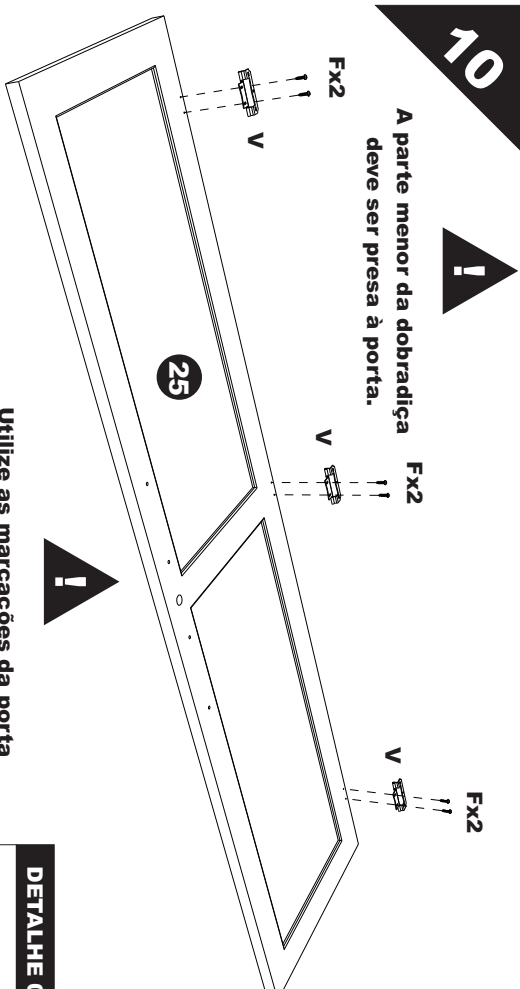

**Utilize as marcações da porta para fixar as dobradiças.**

Fixe a parte menor das dobradiças (V) nas portas utilizando as marcações como auxílio. Repita o processo nas outras portas (26 e 27).

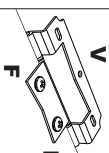
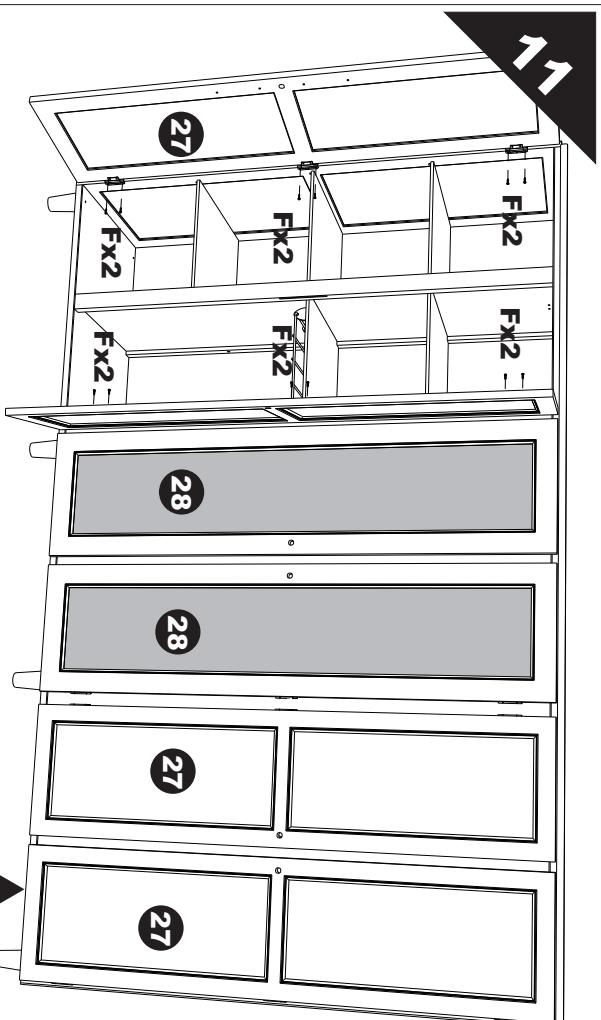
**DETALHE 02****11**

**Repita o passo para instalar as outras portas.**

Fixe as portas no roupeiro de modo que fiquem alinhadas em suas alturas e centralizadas entre as colunas e as laterais do roupeiro.

**12**

**! Inserir a guia para chave (R) no furo da porta e posicionar a chave (S) antes de fixar a fechadura (T), evitando posicionamento incorreto.**

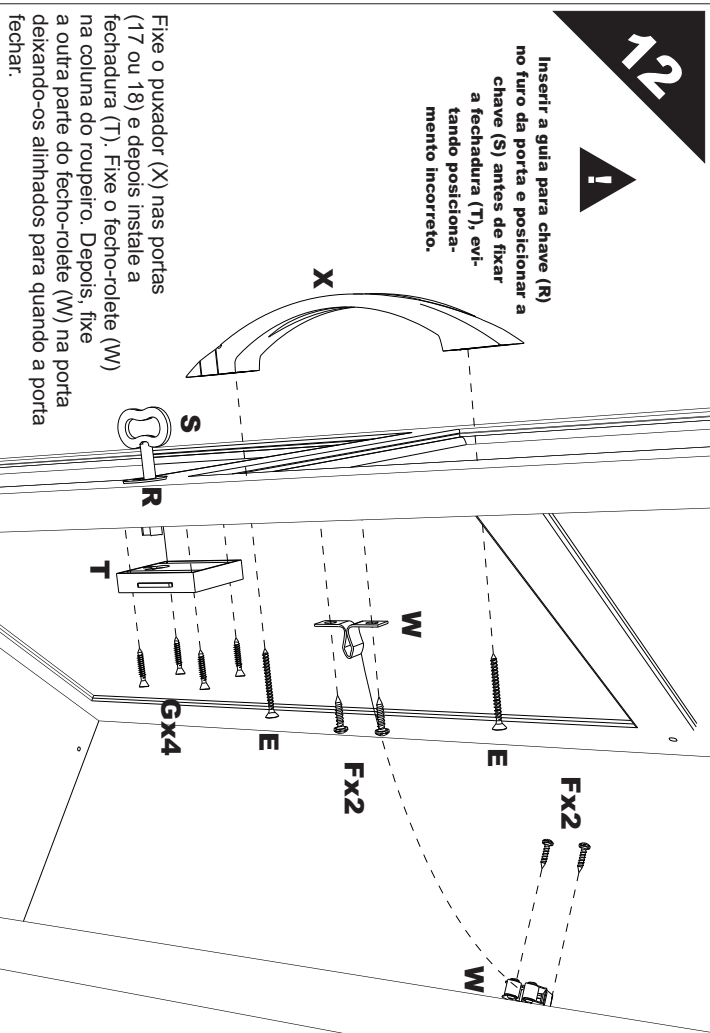

Fixe o puxador (X) nas portas (17 ou 18) e depois instale a fechadura (T). Fixe o fecho-roléte (W) na coluna do roupeiro. Depois, fixe a outra parte do fecho-roléte (W) na porta deixando-os alinhados para quando a porta fechar.

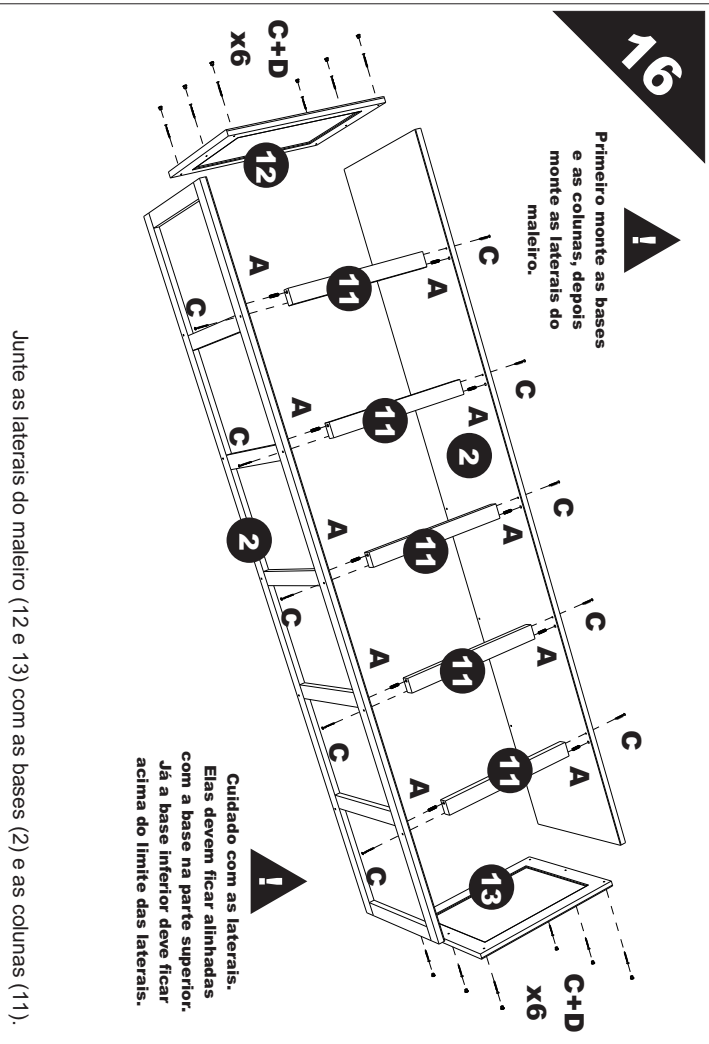
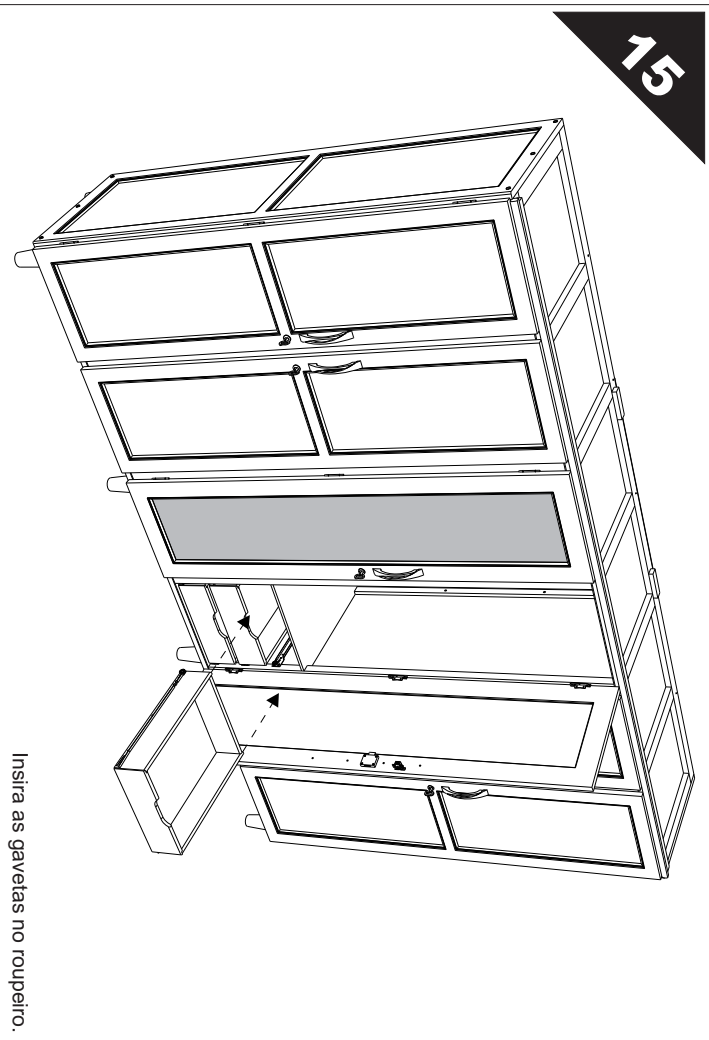
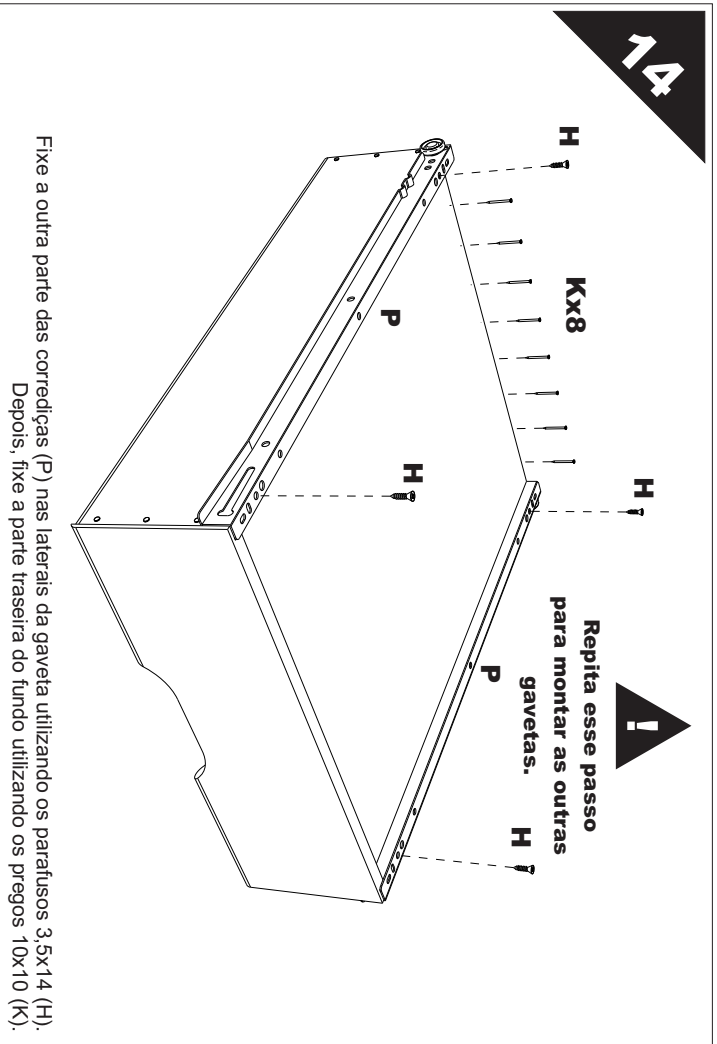
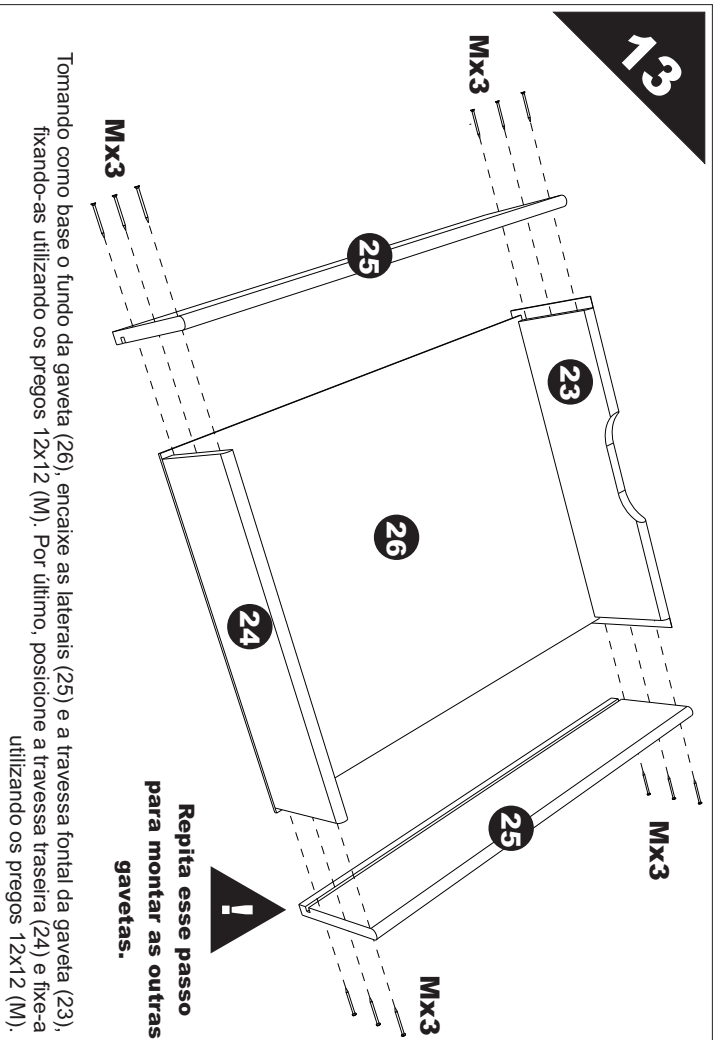

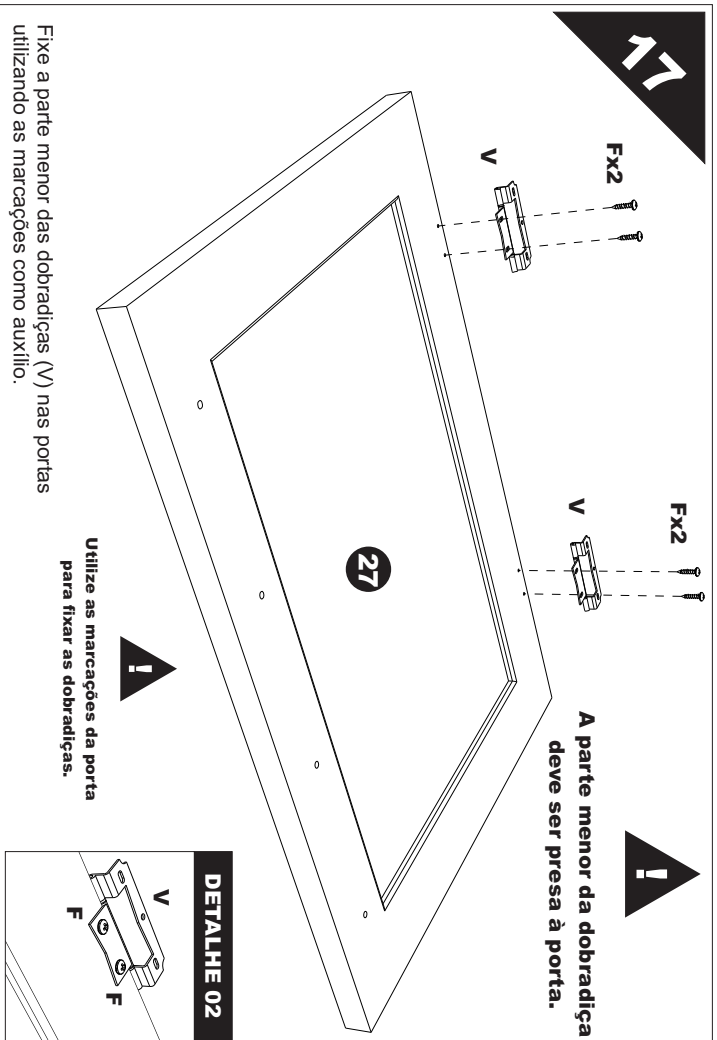

17

A parte menor da dobradiça deve ser presa à porta.

Utilize as marcações da porta para fixar as dobradiças.

DETALHE 02

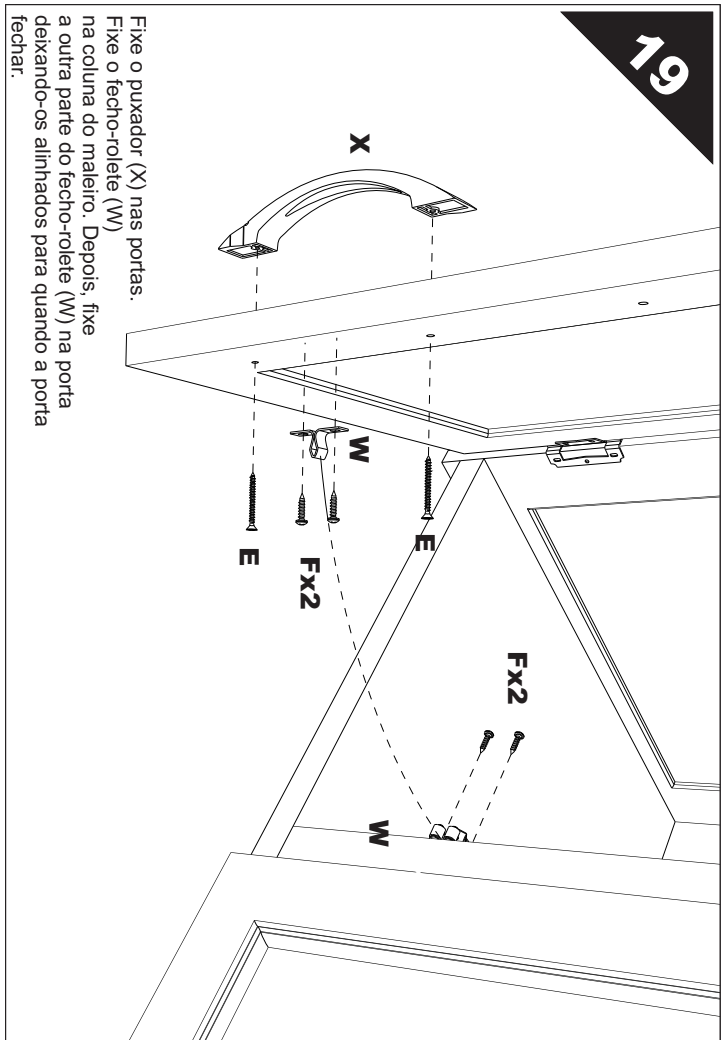

19

Fixe o puxador (X) nas portas.  
Fixe o fecho-roléte (W)  
na coluna do malleiro. Depois, fixe  
a outra parte do fecho-roléte (W) na porta  
deixando-os alinhados para quando a porta  
fechar.

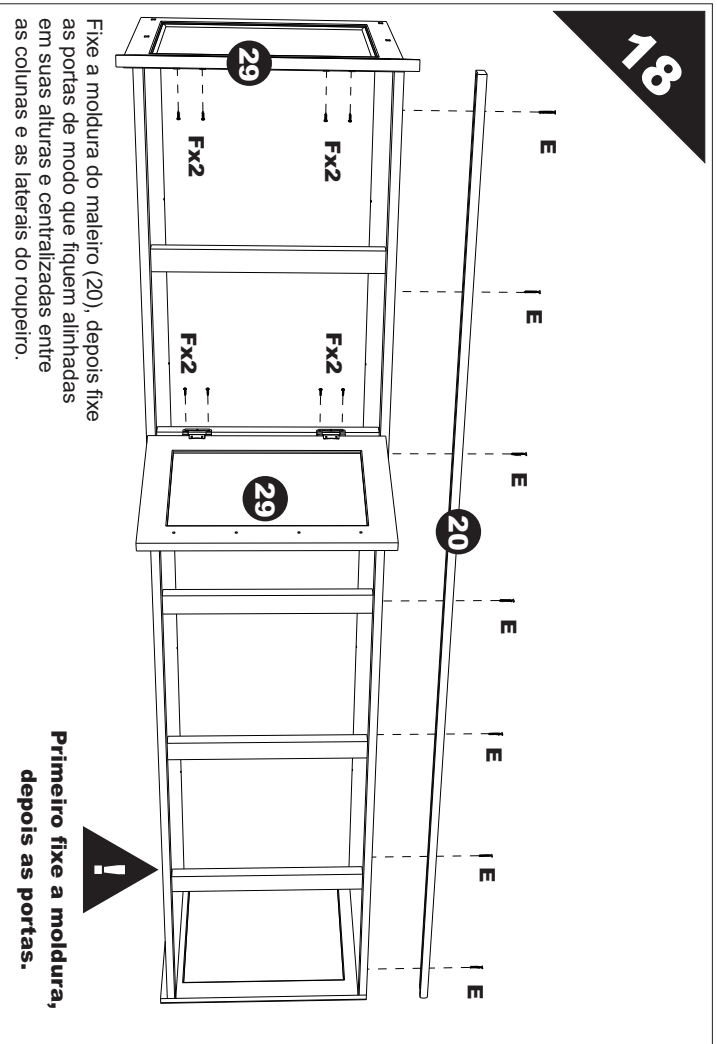

18

Primeiro fixe a moldura, depois as portas.

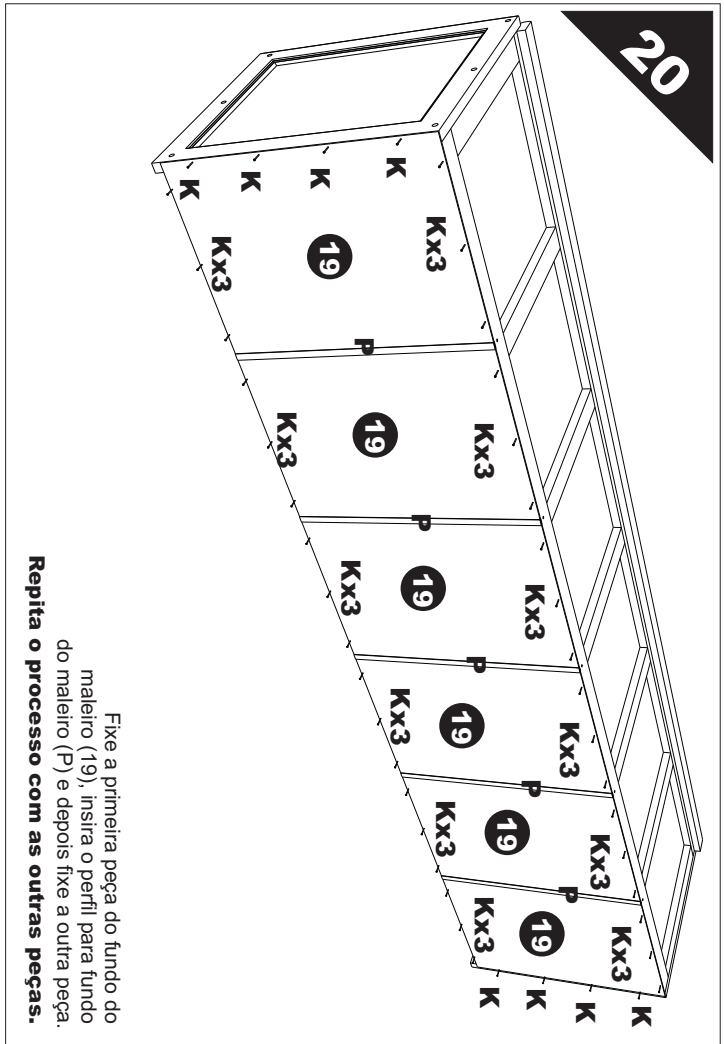

20

Fixe a primeira peça do fundo do malleiro (19), insira o perfil para fundo do malleiro (P) e depois fixe a outra peça.  
**Repita o processo com as outras peças.**

21

Coloque os apoios do maleiro (30) nos locais indicados e fixe-os utilizando os parafusos 4x30 (E). Depois alinhe o maleiro sobre o roupeiro.

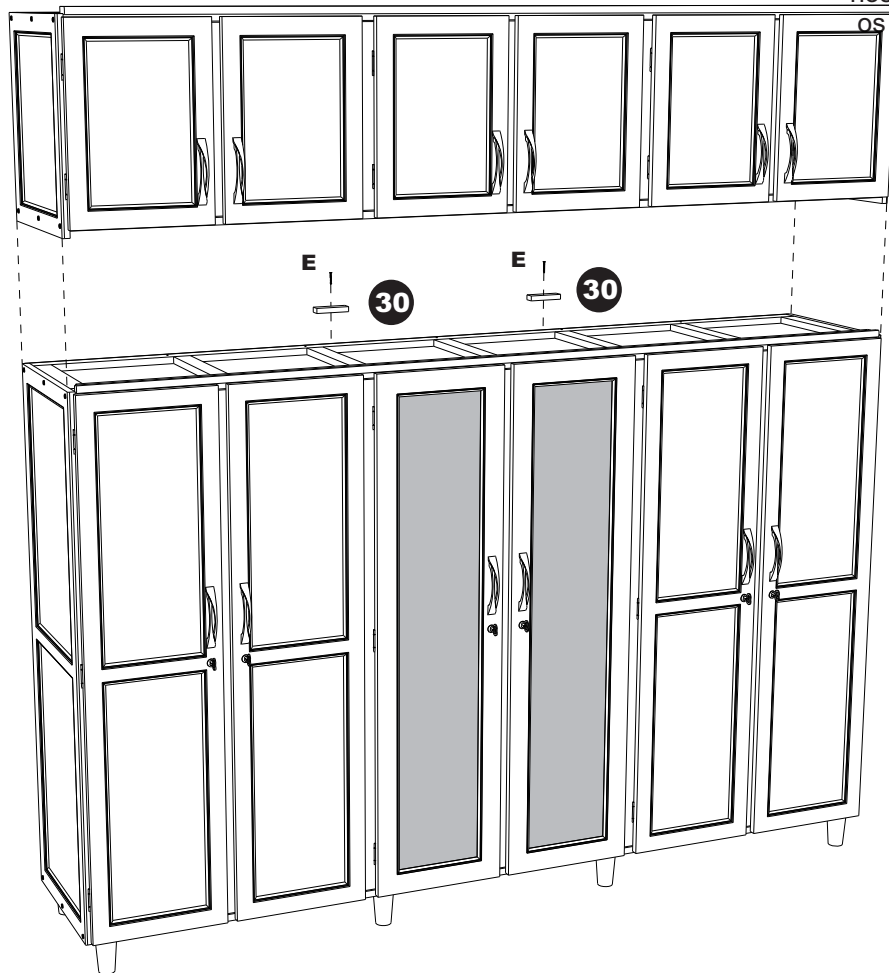

**MÓVEL CONCLUÍDO**

