

CAVAZOTTO

Rua Florianópolis, 570 - Centro - Coronel Freitas - SC - Brasil - CEP: 89840-000
Telefone: +55 (49) 3347-0207 - cavazotto@cavazotto.com.br

MANUAL DE MONTAGEM

ROUPEIRO CAPELINHA



COMPONENTES

- | | | |
|--|---|--|
| 1 - Base inferior (2500x500x23mm) | 14 - Prateleira menor (x3) (469x400x9mm) | 28 - Travessa lateral da gaveta (x8) (450x95x11mm) |
| 2 - Base (x3) (2500x500x23mm) | 15 - Prateleira maior (469x420x9mm) | 29 - Travessa frontal da gaveta (x4) (755x95x11mm) |
| 3 - Lateral do roupeiro (x2) (500x1545x20mm) | 16 - Prateleira calceiro (469x420x9mm) | 30 - Fundo da gaveta (x4) (775x450x3mm) |
| 4 - Pés (x8) (50x50x950mm) | 17 - Prateleira dupla (820x469x9mm) | 31 - Moldura inferior/superior do espelho (x2) (740x65x20mm) |
| 5 - Divisória (460x1500x3mm) | 18 - Fundo do roupeiro (x4) (420x1545x3mm) | 32 - Moldura lateral do espelho (x2) (725x65x20mm) |
| 6 - Divisória esquerda da cômoda (500x1500x50mm) | 19 - Fundo do maleiro (x6) (420x545x3mm) | 33 - Espelho (opcional) (745x630x3mm) |
| 7 - Divisória direita da cômoda (500x1500x50mm) | 20 - Fundo da cômoda (x4) (210x785x3mm) | 34 - Porta do roupeiro (x4) (390x1535x20mm) |
| 8 - Coluna frontal (x2) (50x1500x30mm) | 21 - Moldura inferior (2500x45x20mm) | 35 - Porta do maleiro (x6) (390x535x20mm) |
| 9 - Coluna traseira da divisória (30x1500x30mm) | 22 - Moldura da cômoda (800x45x20mm) | 36 - Moldura superior (2500x45x20mm) |
| 10 - Coluna traseira (30x1500x30mm) | 23 - Cabideiro (820x20x20mm) | 37 - Apoio do maleiro (x2) (100x30x15mm) |
| 11 - Coluna do maleiro (x5) (50x500x30mm) | 24 - Tampo da cômoda (845x520x9mm) | |
| 12 - Lateral esquerda do maleiro (500x565x20mm) | 25 - Travessa da cômoda (x5) (800x55x20mm) | |
| 13 - Lateral direita do maleiro (500x565x20mm) | 26 - Frente da gaveta (x4) (815x150x20mm) | |
| | 27 - Travessa traseira da gaveta (x4) (755x95x11mm) | |

FERRAMENTAS NECESSÁRIAS

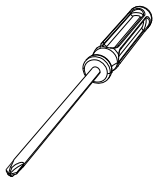

Chave philips

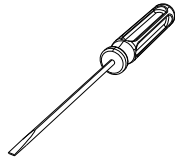

Chave de fenda

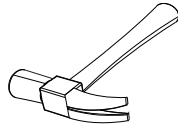

Martelo

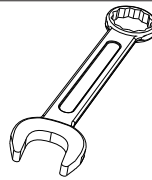

Chave de boca nº6

FERRAGENS

A

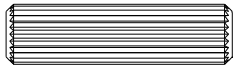

Cavilha 8x30 (x44)

B

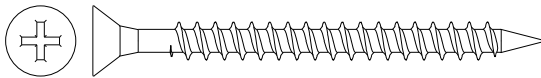

Parafuso philips 5,0x60mm (x8)

C

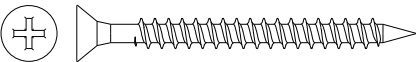

Parafuso philips 4,0x45mm (x54)

D



Tapa-furo
10mm (x26)

E



Parafuso philips 3,5x30mm (x90)

F



Parafuso philips
3,5x16mm cabeça
panela (x142)

G

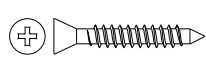

Parafuso philips cab
chata 3,5x25mm (x16)

H

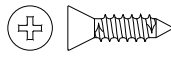

Parafuso philips
3,5x14mm (x32)

I

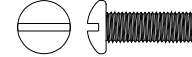

Parafuso fenda
5/32x5/16 cabeça
panela (x2)

J



Porca nº6
(x2)

K

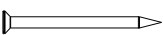

Prego 10x10 (x220)

L



Suporte para
prateleira (x25)

ACESSÓRIOS

N

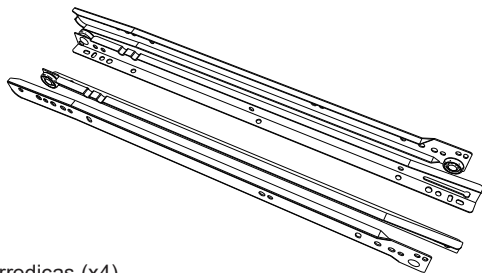

Par de correias (x4)

O

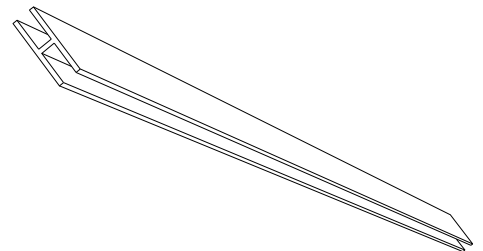

Perfil 785mm para fundo da cômoda (x3)

P

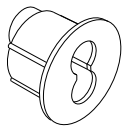

Guia para chave (x4)

Q

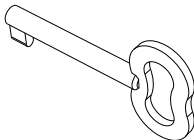

Chave (x4)

R



Perfil 545mm para fundo do maleiro (x5)

S

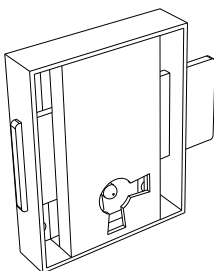

Fechadura (x4)

T

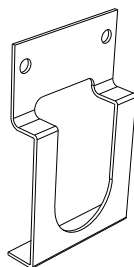

Suporte para
cabideiro (x2)

U

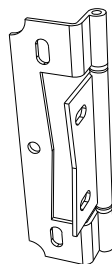

Dobradiça (x24)

V

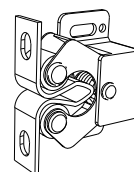

Fecho rolete (x10)

X

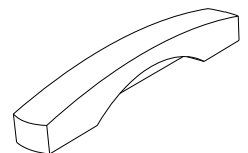

Puxador (x18)

01

A base inferior possui mais furos do que as outras para a fixação dos pés.

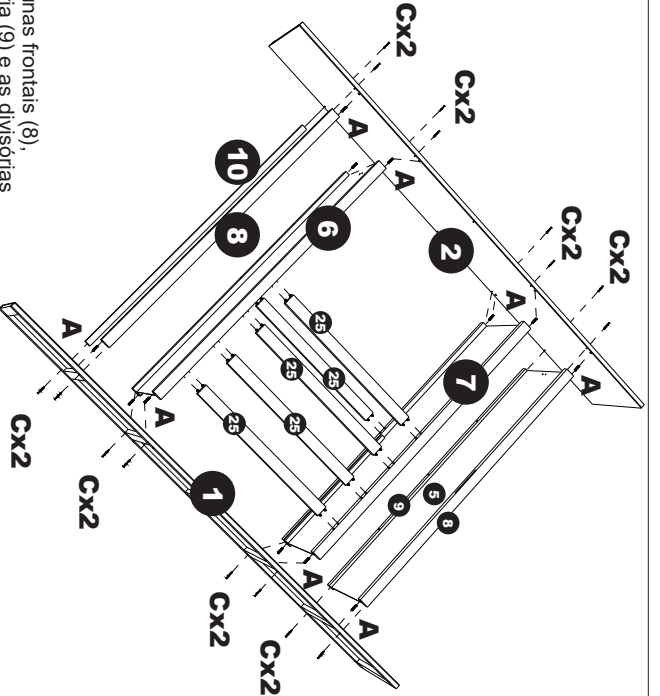

Junte as bases (1 e 2) com as colunas frontais (8), a traseira (10), a traseira da divisória (9) e as divisórias da cômoda (6 e 7) encaixando as travessas da cômoda (25) e depois fixe utilizando os parafusos 4x45 (C).

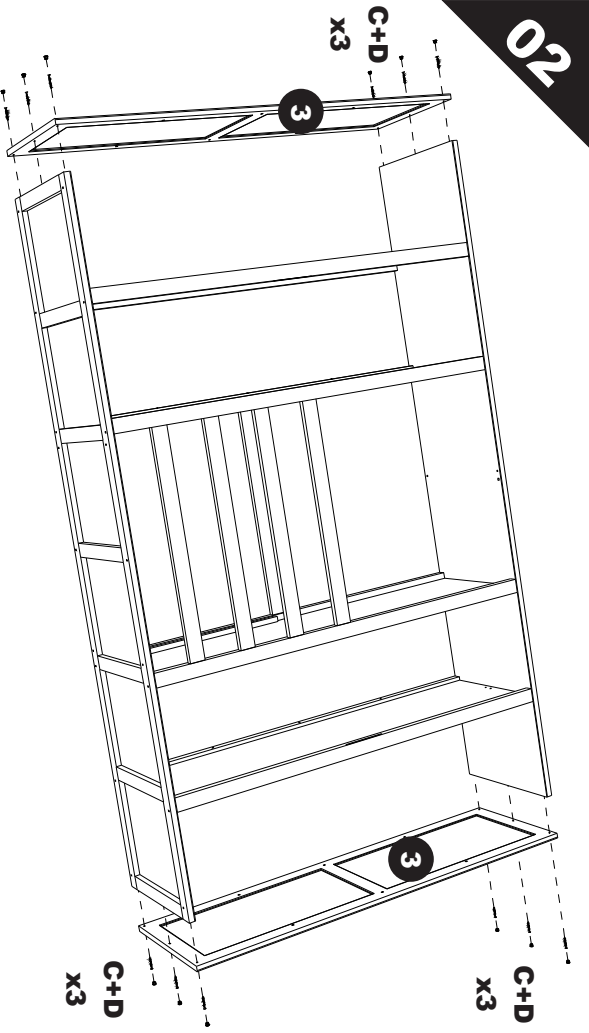
02

Fixe as laterais do roupeiro (3) nas bases (1) e (2) utilizando os parafusos 4x45 (C) e depois cubra os parafusos com os tapa-furos (D).

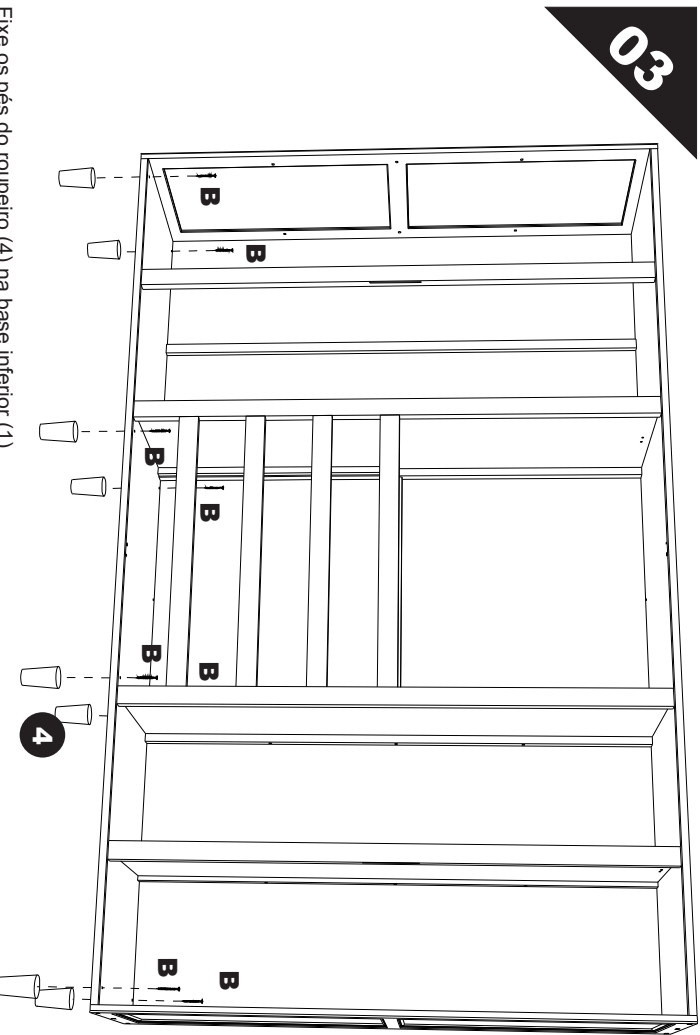
03

Fixe os pés do roupeiro (4) na base inferior (1).

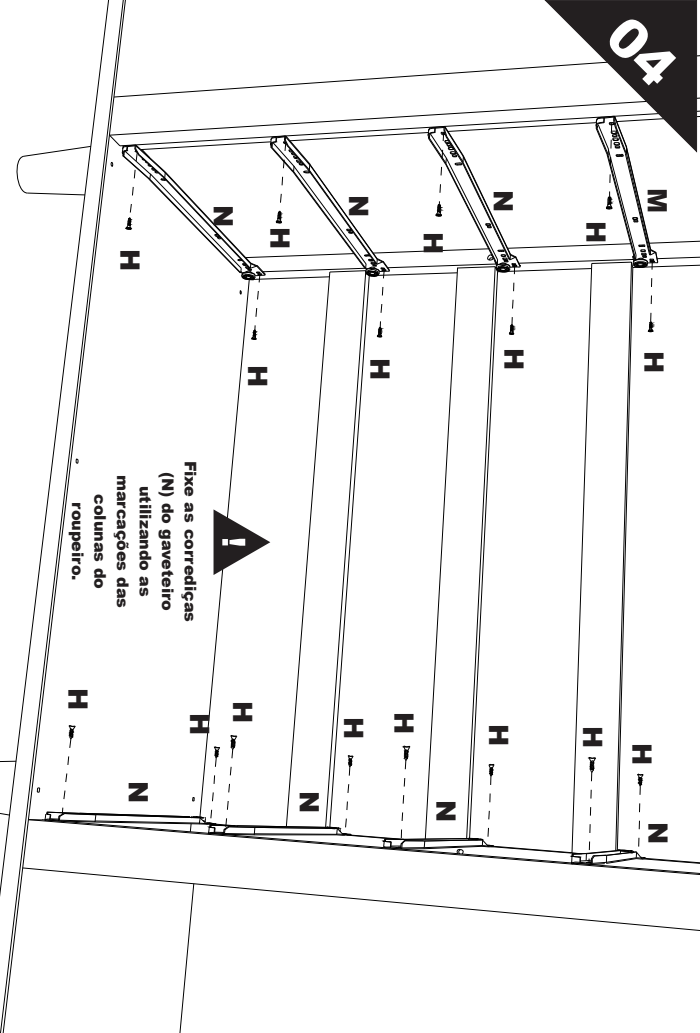
04

Fixe as corredeiras (N) do gaveteiro utilizando as marcações das colunas do roupeiro.

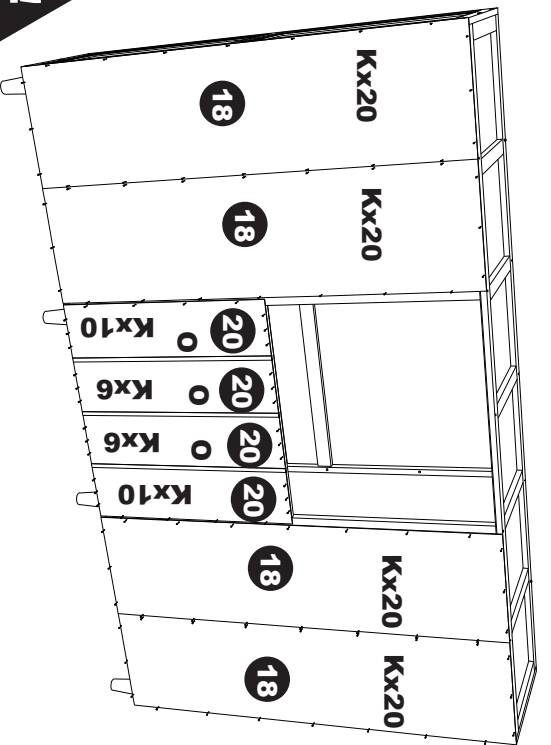
05

Coloque a estrutura do roupeiro no esquadro perfeito antes de fixar o fundo.

Com o roupeiro nivelado, fixe os fundos (18 e 20) com os 20 pregos (K) por peça.

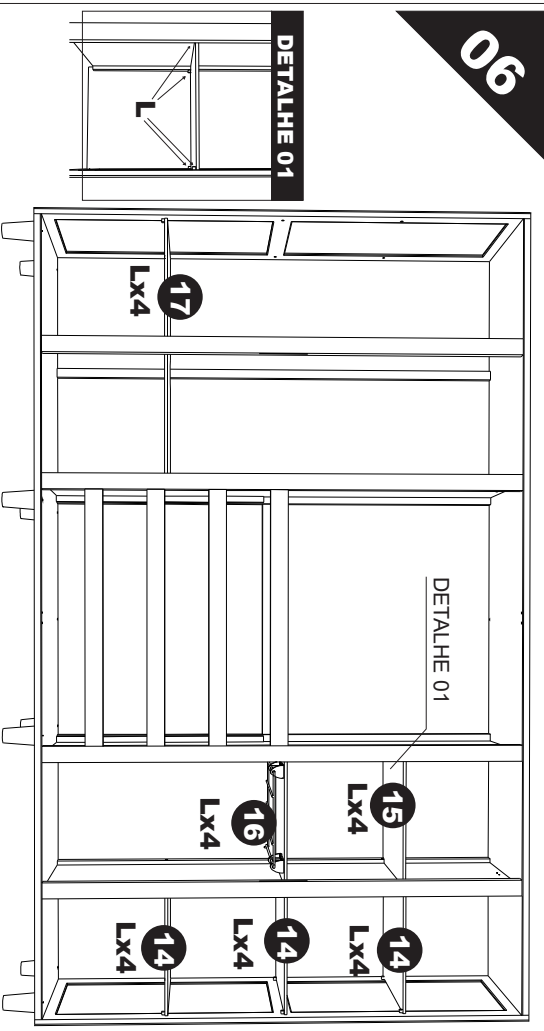
06

Coloque os suportes para prateleiras (L) nos furos localizados nas divisórias da cómoda (6 e 7) e nas laterais e colunas do roupeiro. Depois coloque as prateleiras nos locais indicados.

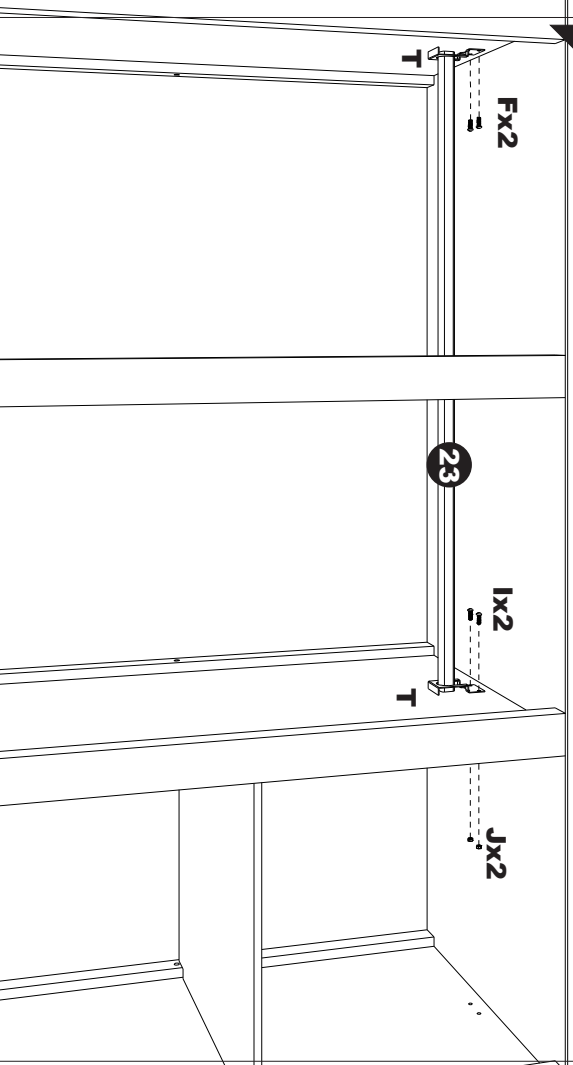
07

Fixe os suportes para cabideiro (T) na lateral do roupeiro (3) e na divisória esquerda da cómoda (6). Depois encaixe o cabideiro (23) nos suportes (T).

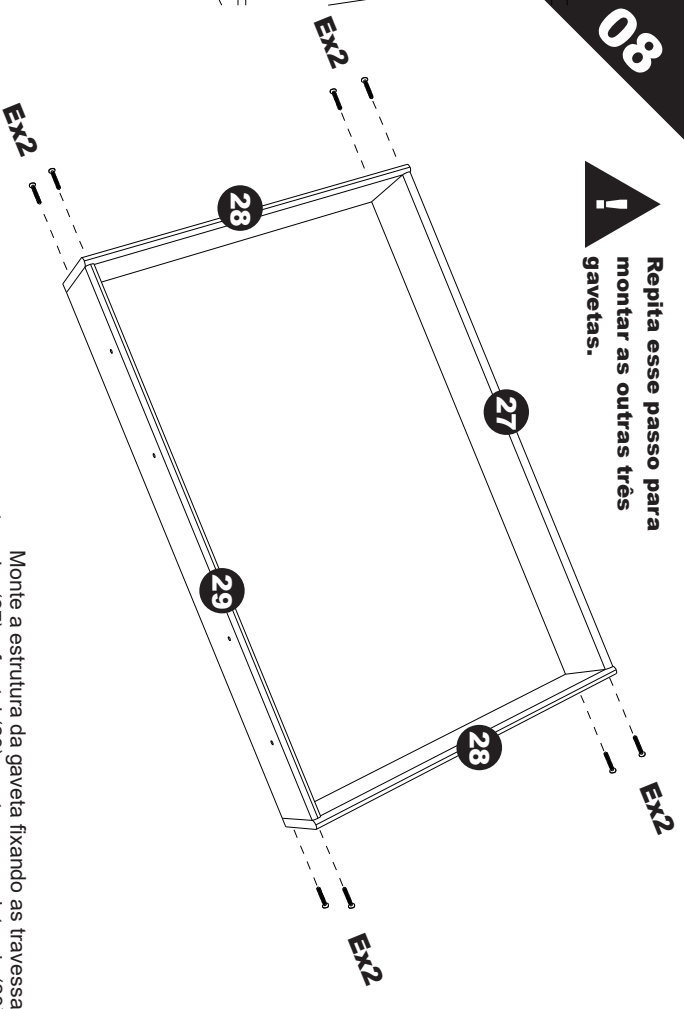
08

Repita esse passo para montar as outras três gavetas.

Monte a estrutura da gaveta fixando as travessas traseira (27) e frontal (29) nas travessas laterais (28).

09

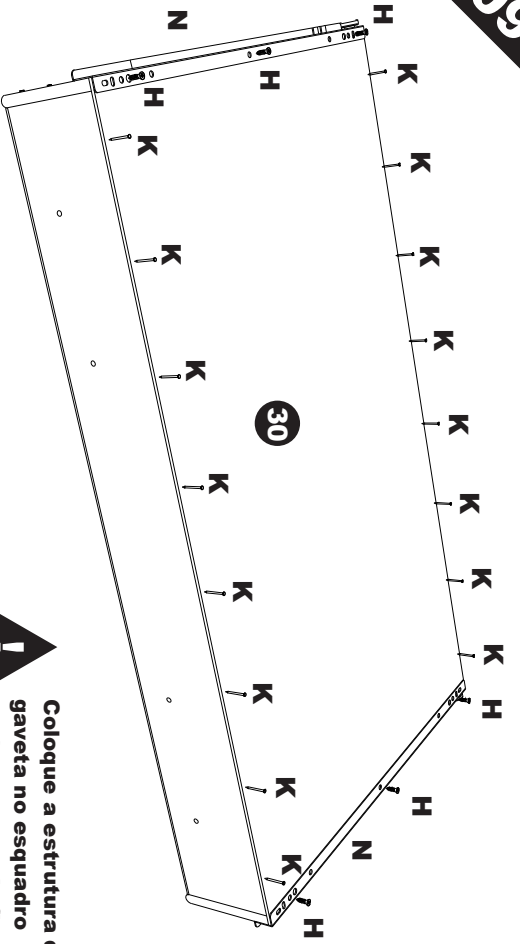

Coloque a estrutura da gaveta no esquadro perfeito antes de fixar o fundo.

Com a estrutura virada, alinhe o fundo da gaveta (30) e prenda a outra parte da correção (N) nas laterais inferiores da gaveta. Depois, fixe as outras partes do fundo com os pregos (K).

10

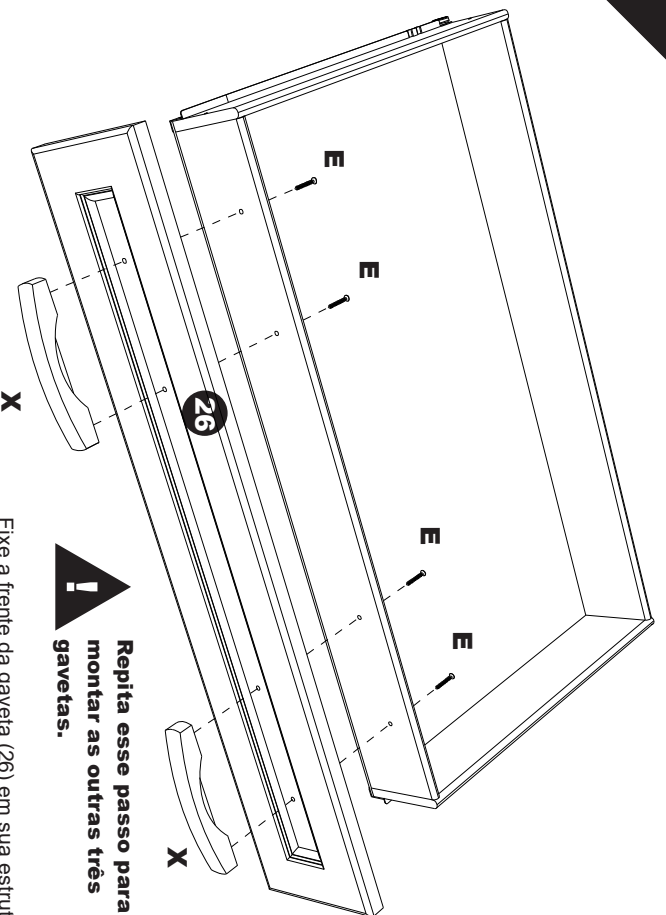

Repita esse passo para montar as outras três gavetas.

Fixe a frente da gaveta (26) em sua estrutura em conjunto com os puxadores (X).

12

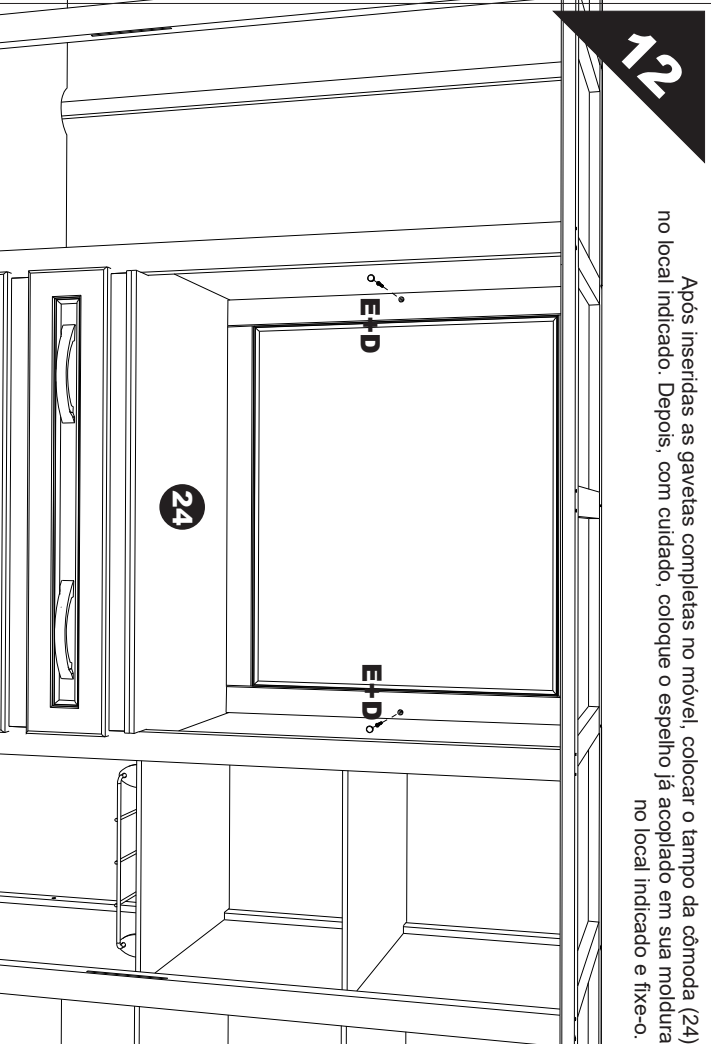

Após inseridas as gavetas completas no móvel, colocar o tampo da cômoda (24) no local indicado. Depois, com cuidado, coloque o espelho já acoplado em sua moldura no local indicado e fixe-o.

11

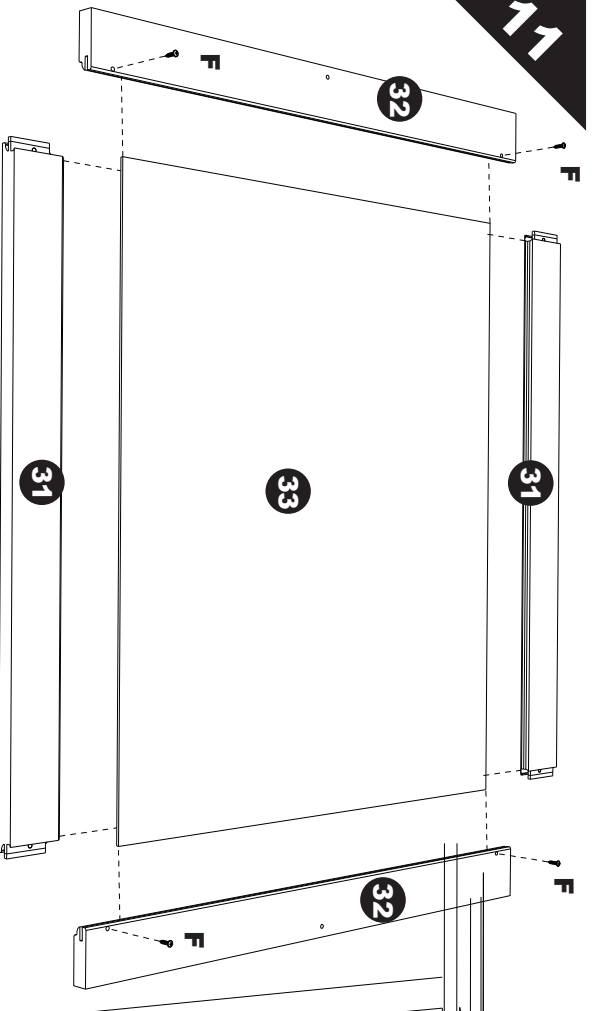

Para montar a moldura em volta do espelho, encaixe as peças e depois fixe-as utilizando os parafusos 3,5x16 cabeça panela (F).

13

Fixe a moldura da cômoda (22) antes da moldura inferior (21).

Fixe a moldura da cômoda (22) parafusando-a de cima para baixo. Depois fixe a moldura inferior (21) também parafusando de cima para baixo.

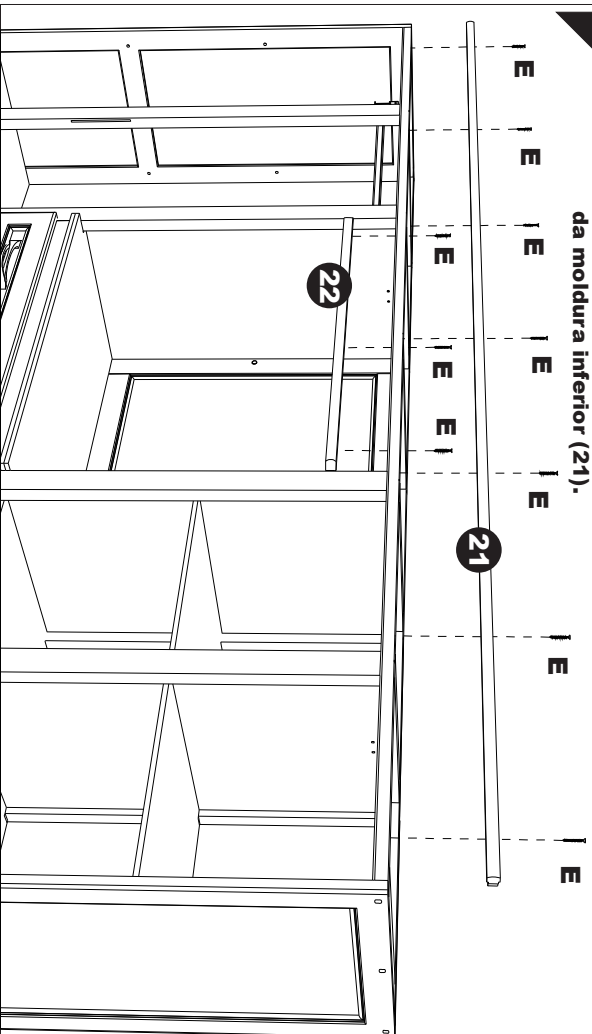
**14**

A parte menor da dobradiça Fx2 deve ser presa à porta.

Utilize as marcações da porta para fixar as dobradiças.

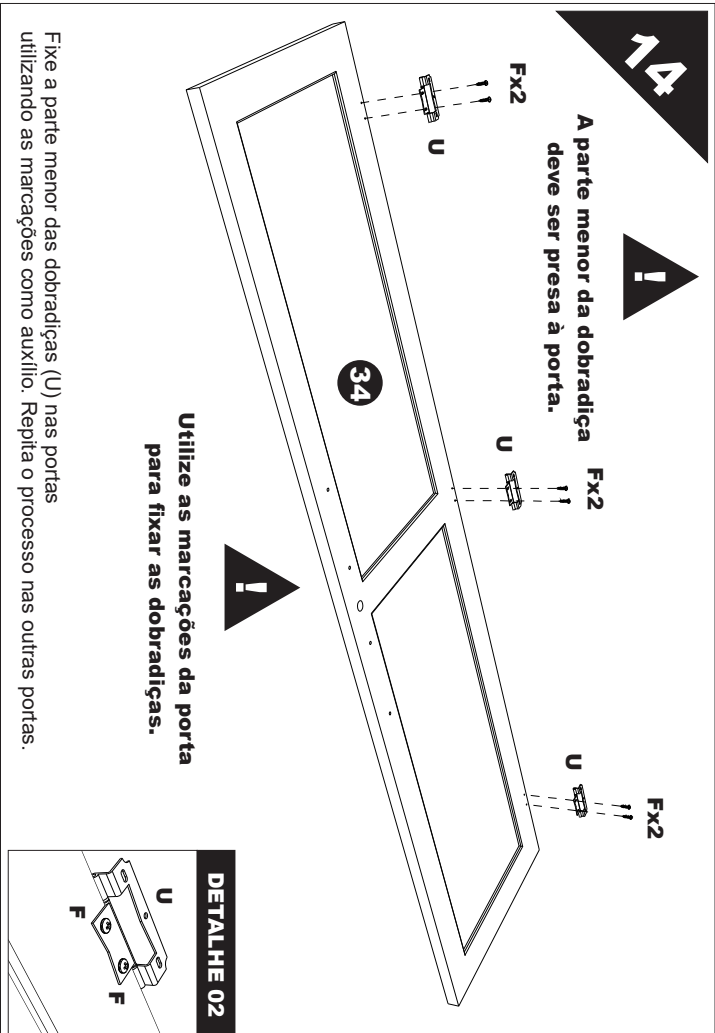
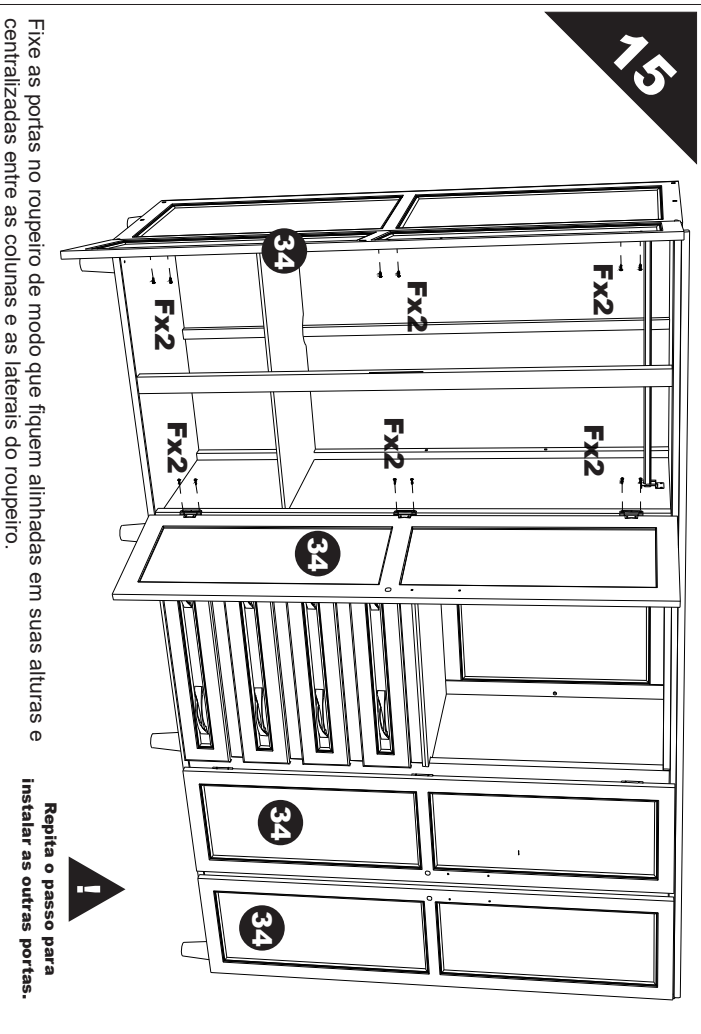
**15**

Fixe as portas no roupeiro de modo que fiquem alinhadas em suas alturas e centralizadas entre as colunas e as laterais do roupeiro.

Repita o passo para instalar as outras portas.

16

Inserir a guia para chave (p) no furo da porta e posicionar a chave (q) antes de fixar a fechadura (s), evitando posicionamento incorreto.

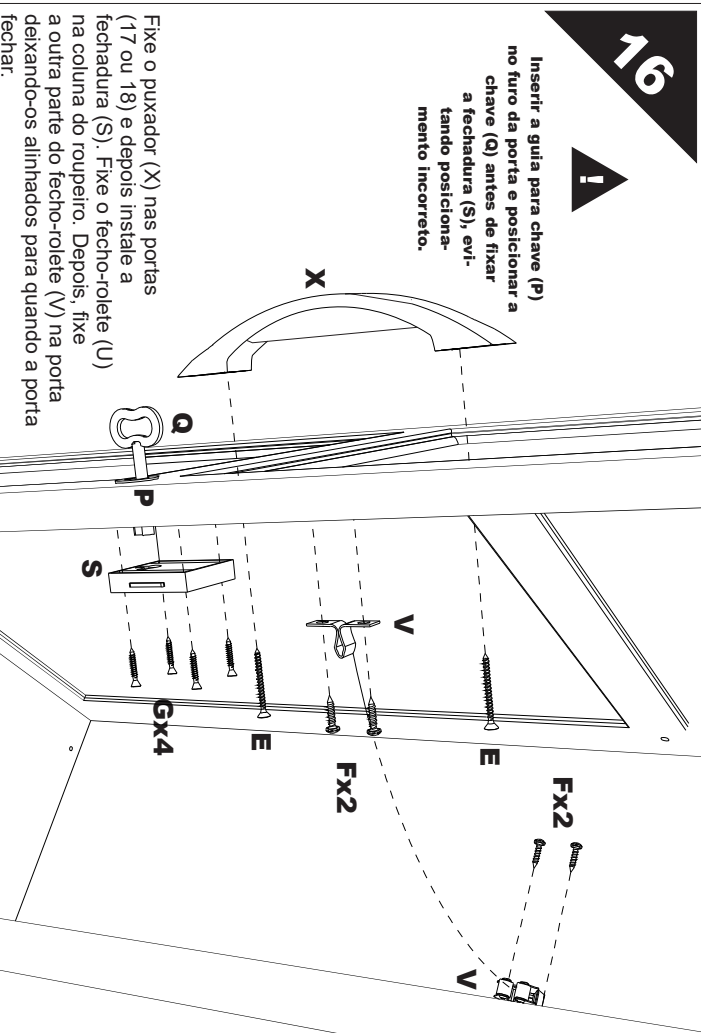

Fixe o puxador (X) nas portas (17 ou 18) e depois instale a fechadura (S). Fixe o fecho-roléte (U) na coluna do roupeiro. Depois, fixe a outra parte do fecho-roléte (V) na porta deixando-os alinhados para quando a porta fechar.

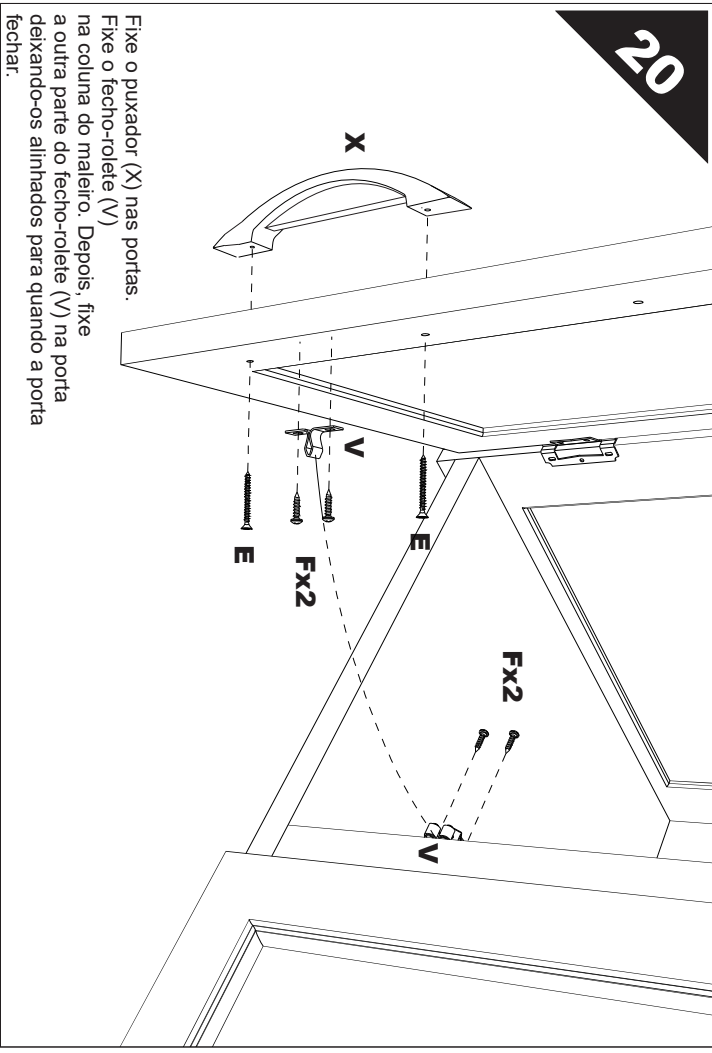
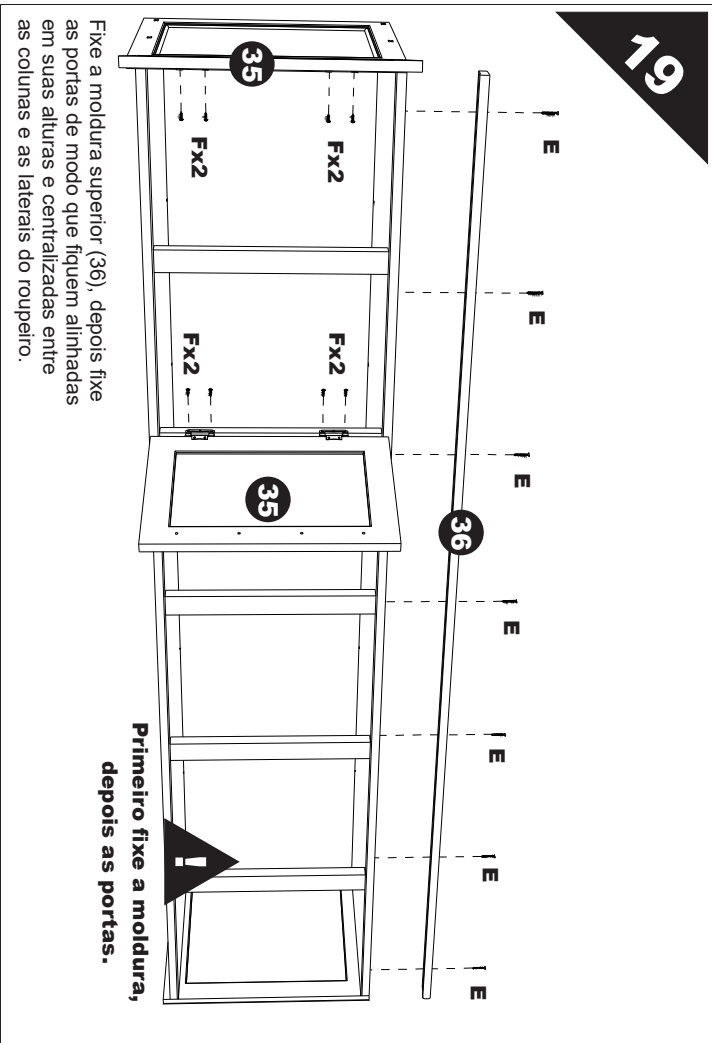
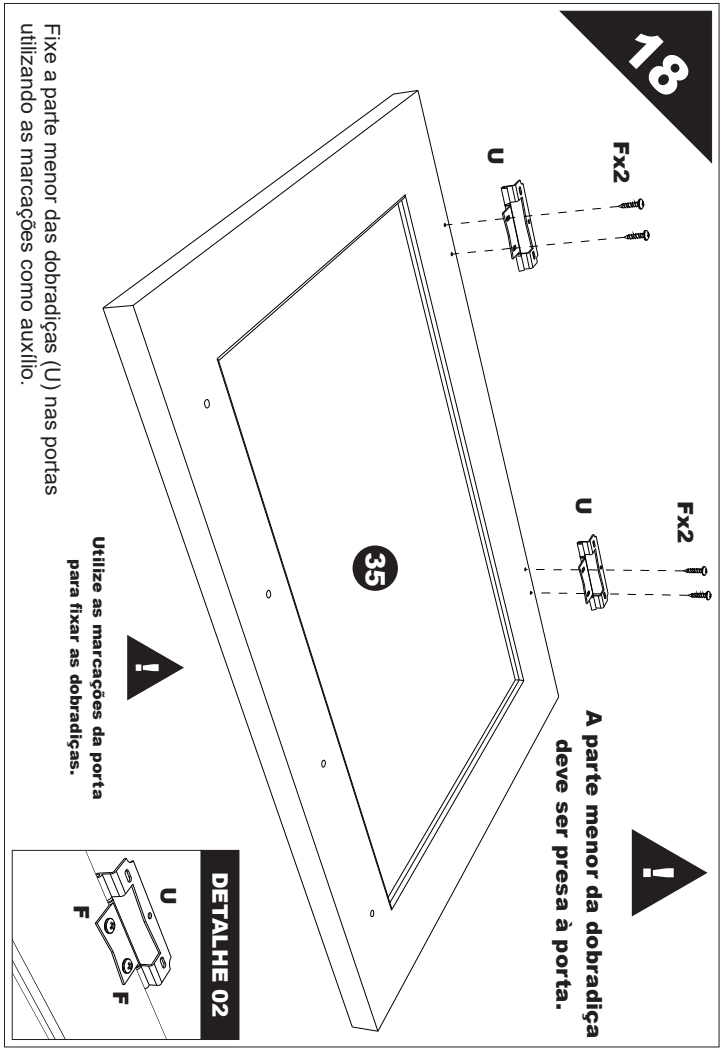
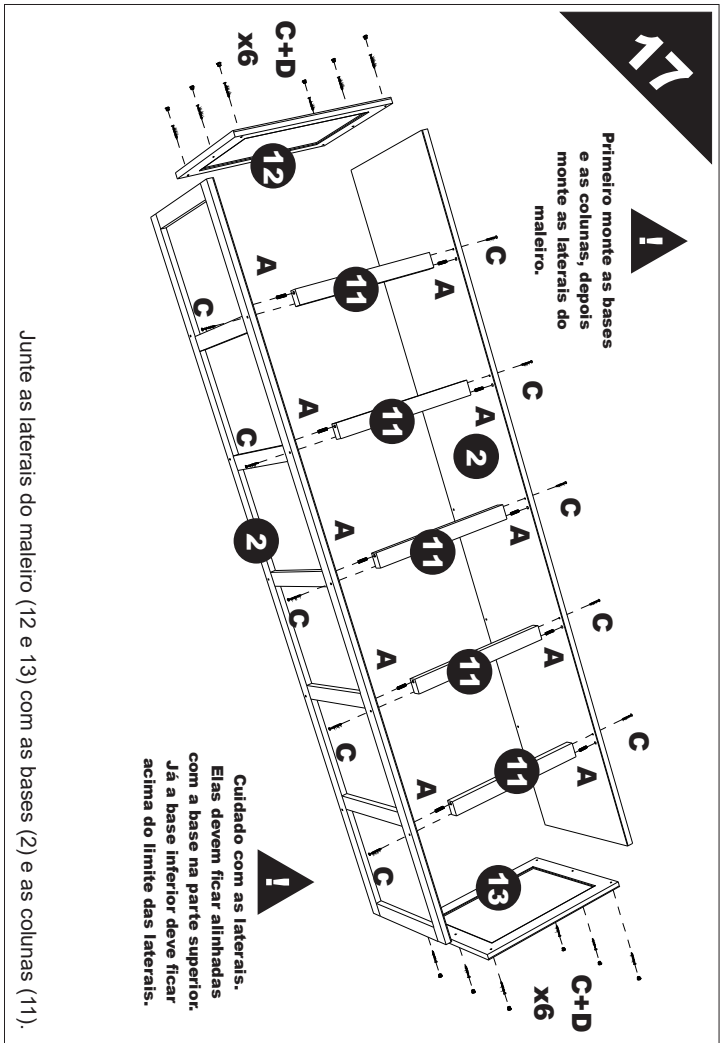

21

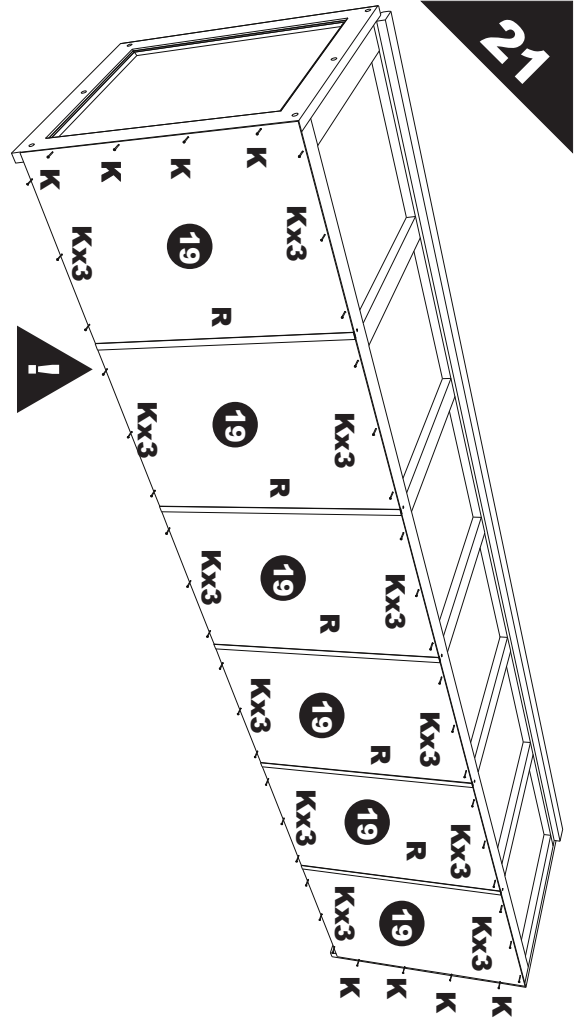

Coloque a estrutura do maleiro no esquadro perfeito antes de fixar o fundo.

Fixe a primeira peça do fundo do maleiro (19), insira o perfil para fundo do maleiro (R) e depois fixe a outra peça. **Repita o processo com as outras peças.**

22

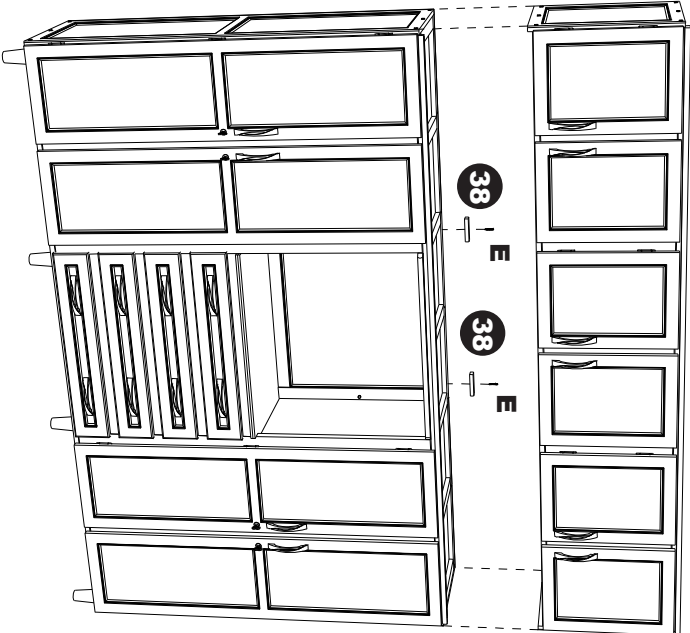

Fixe os apoios do maleiro (38) utilizando os parafusos 4x30 (E). Depois alinhe o maleiro sobre o roupeiro.

MÓVEL CONCLUÍDO

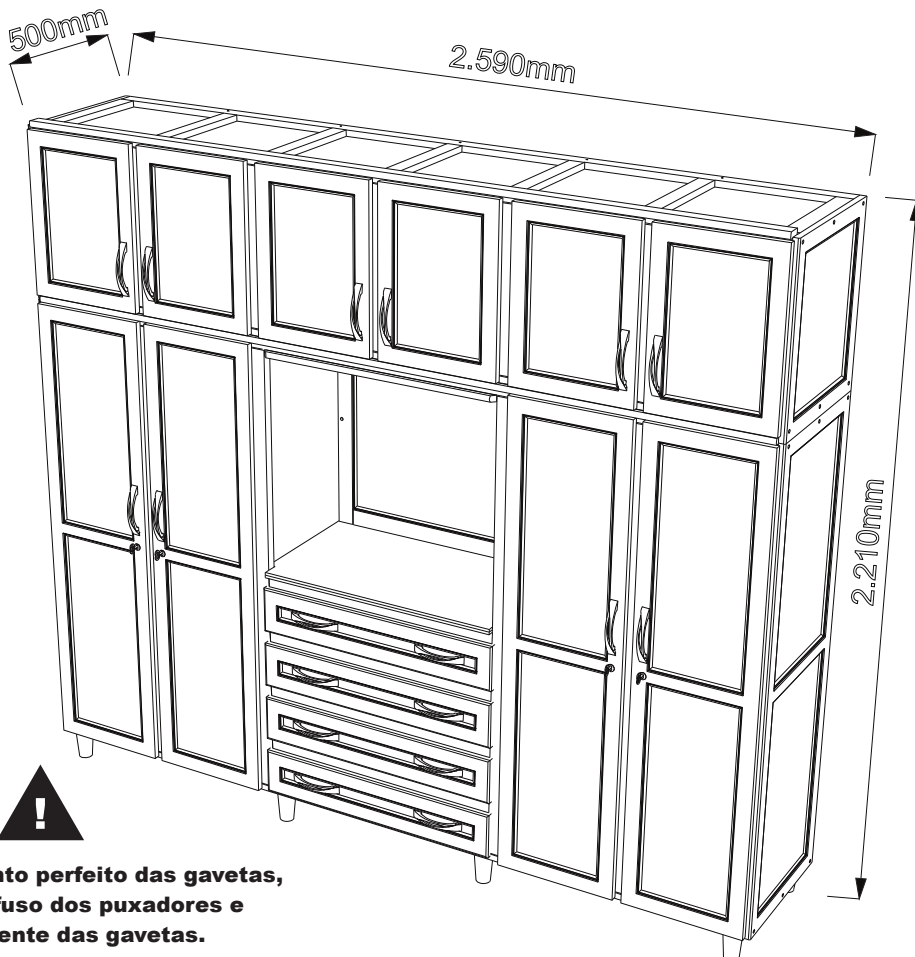

Para o alinhamento perfeito das gavetas, solte os parafusos dos puxadores e ajuste a frente das gavetas.