

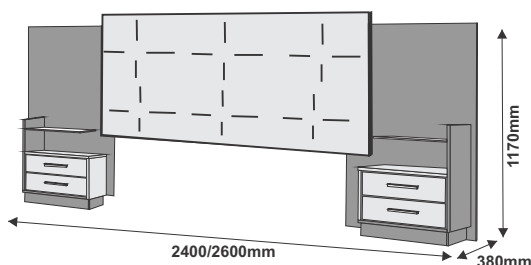

Av. das Indústrias, nº 157 - Bairro Belo Horizonte - Rodeiro /MG
 Fone/Fax (32) 3577 - 3950
 www.leifermoveis.com.br - assistencia@leifermoveis.com.br

PAINEL BOX GALAXY NEW

PAINEL BOX GALAXY PRATA - CÓD: 45
 PAINEL BOX GALAXY BRONZE - CÓD: 9207





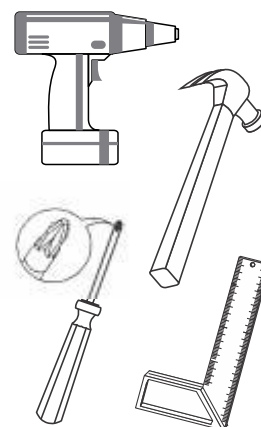







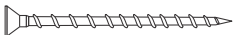

Ferramentas Necessárias:

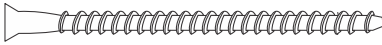

ESQUEMA DE MONTAGEM

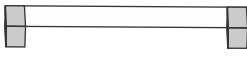
15/10/2019

 Parafuso 4,0x40 chato 24UN	 Cantoneira 04 Furos 16UN	 Parafuso 7 x 40 04UN
 Parafuso 3,5x14 chato 114UN	 Sapata Plástica 08UN	 Parafuso 4,0 x 30 chato - Puxador 08UN
 Parafuso Flangeado 4,0x25 02UN	 Parafuso 5,0 x 50 flangeado 24UN	 Par de Corrediça 300MM 04UN
 Cavilha 6,0x30 16UN	 Tampa Cabeça 10mm 16UN	 Puxador 04UN
	 Etiqueta Leifer 01UN	 Suporte do Vidro 04UN

Nº	DESCRIÇÃO	QT.	CÓD. CANELA	CÓD. YPÊ	CÓD. BRANCO	CÓD. IMBUIA
01	PAINEL ESTOFADO BOX	01	0602	0602	0602	0602
02	PAINEL LATERAL DIREITO	01	0572	0572	0572	0572
03	PAINEL LATERAL ESQUERDO	01	0573	0573	0573	0573
04	BASE CRIADO	02	0570	0570	0570	0570
05	LATERAL EXTERNA DIREITA	01	0587	0587	0587	0587
06	LATERAL EXTERNA ESQUERDA	01	0590	0590	0590	0590
07	LATERAL INTERNA	02	0592	0592	0592	0592
08	TAMPO CRIADO	02	0567	0567	0567	0567
09	RODAPÉ FRONTAL	02	0596	0596	0596	0596
10	RODAPÉ TRASEIRO	02	0598	0598	0598	0598
11	RODAPÉ LATERAL	04	0597	0597	0597	0597
12	FRENTE DE GAVETA	04	0575	0575	0575	0575
13	LATERAL DIREITA DE GAVETA	04	0580	0580	0580	0580
14	LATERAL ESQUERDA DE GAVETA	04	0585	0585	0585	0585
15	FUNDO DE GAVETA	04	0578	0578	0578	0578
16	TRASEIRO DE GAVETA	04	0600	0600	0600	0600
17	VIDRO DOS CRIADOS	02	-----	-----	-----	-----
18	KIT FERRAGEM (BRONZE)	01	9800	9800	9800	9800
19	KIT FERRAGEM (PRATA)	01	9808	9808	9808	9808

01- COMECE A MONTAGEM PELO RODAPÉ:

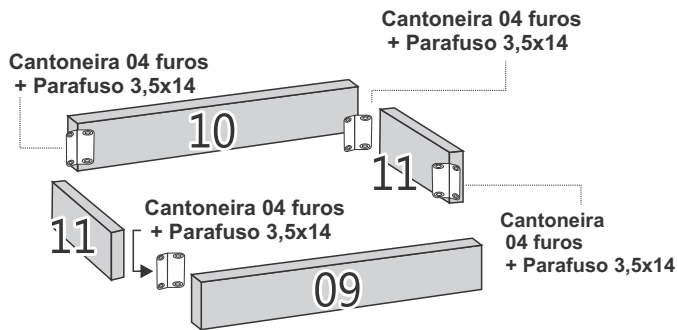

02- MONTAGEM DO CRIADO LATERAL ESQUERDO:

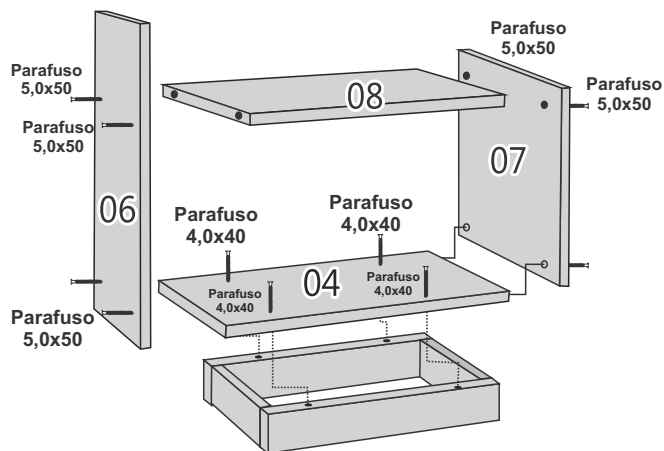

03- MONTAGEM DO CRIADO LATERAL DIREITO:

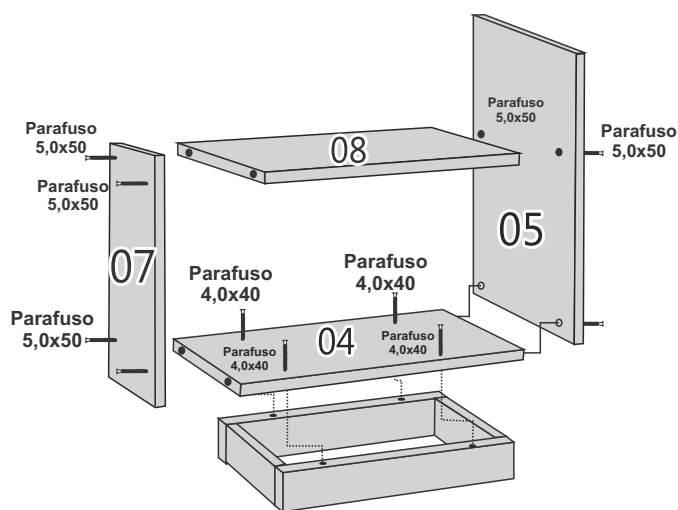

04-

Suporte do Vidro - Parafusar na Lateral do Criado usando parafuso 3,5x14.

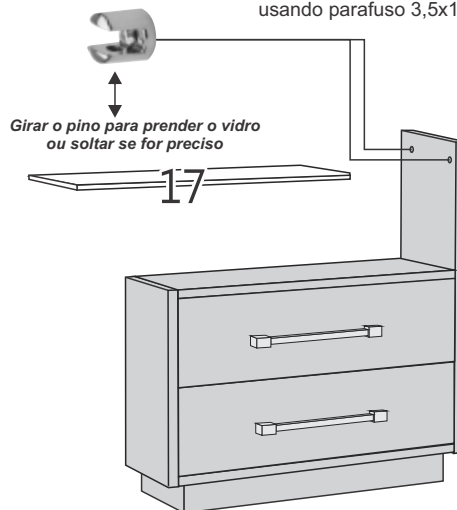

05-

MONTAGEM DO PAINEL TRASEIRO NO CRIADO.

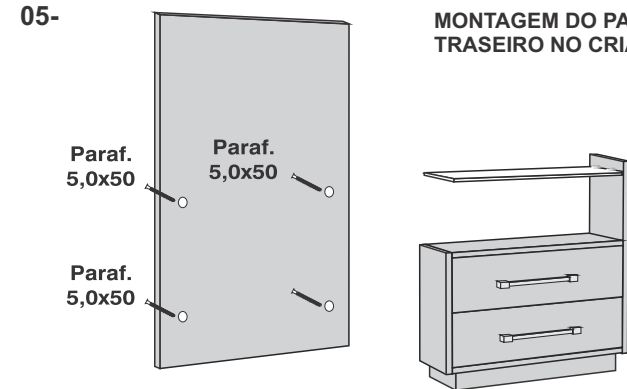

Painel Central Estofado

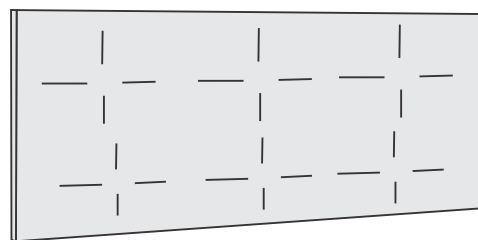

06- MONTAGEM DAS GAVETAS

07- MONTAGEM DO PAINEL ESTOFADO NOS CRIADOS

